

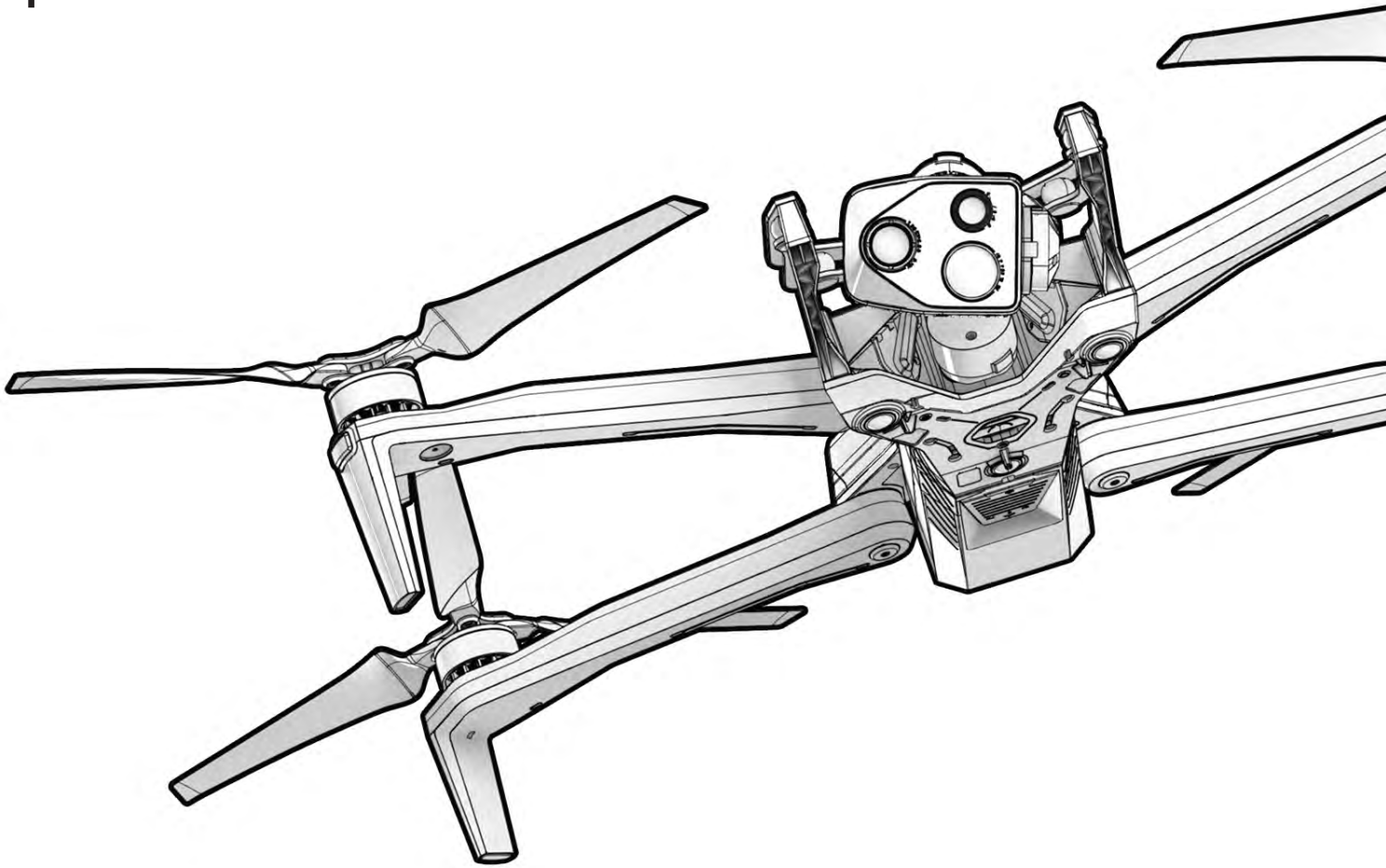

Skydio X10D INTL

Operator Manual



Vehicle version: **37.1.182**
Controller version: **37.1.160**

Document version: **5.0**
Updated: **22 October 2024**



WARNING: Please read all documentation provided with your Skydio X10D, including but not limited to the X10D Safety Guidelines in the Safety and Operating Guide: www.skydio.com/safety. Failure to follow any instructions or recommendations in our documentation may void the Skydio Limited Warranty.

Additional Resources

The Skydio X10D is the offline variant of the X10 and shares hardware, sensor packages, attachments, and controller running Skydio Flight Deck software. However, there are features that make the X10D unique. X10D does not require network connectivity, ensuring that your data is always secure. The X10D multiband radio allows for frequency diversity and longer range in the lower frequency bands. Skydio X10D is an open, modular platform ready for additional payload options. RAS-A compliance and the MAVLINK protocol includes manual vehicle control, autonomous missions, camera and payload control, vehicle-specific skills, radio link and pairing configuration, integration with third-party radios, controllers, and flight application software. The instructions for flying your Skydio X10D are the same as the X10 unless identified in the X10D section.

Scan the QR codes to view more information about flying with Skydio X10D.



Getting Started with
Skydio X10D



Flying with
Skydio X10



Skydio X10D
Resources



Skydio X10D
Maintenance



Skydio X10D Safety
and Operating Guide



Skydio Legal

For legal, warranty and intellectual property information, visit: www.skydio.com/legal

If you need assistance, please reach out to FedSupport@skydio.us

Table of Contents

<u>Flying Safely</u>	1
Safety Guidelines	1
<u>Getting Started</u>	8
Skydio X10D Starter Kit	9
Skydio X10D Hardware	10
Skydio X10D Controller Hardware	12
Skydio X10D Autonomy Features	14
Charging	15
Vehicle Name and Serial Number	21
<u>Preflight</u>	22
Skydio X10D Setup	23
Skydio X10D Controller Setup	26
Updating Skydio X10D System	28
Encryption	30
Importing Maps	31
Battery Warming in Cold Environments	32
<u>Skydio Flight Deck</u>	34
Gate Screen	35
Global Settings	36
Media	37
Information	38
Flight Controls	44
Sensing	50
Return	53
Lighting	58
Connection	59
Radio	61
Display	62
System Status	68
Quick Actions	69
Inflight Map	72

Camera Settings

73

Overview	74
Capture Settings (Photo and Video)	75
Focus and Exposure	76
Zoom (Photo and Video)	77
Shutter Indicators	79
Photo Settings	80
Video Settings	81
Using the VT300-L Flashlight	83

Thermal Camera and Tools

84

Accessing Thermal Options	85
Flat Field Correction (FFC)	87
Thermal Tools	88
Thermal Settings	90
Thermal Parameters	92

Flight

93

Preflight Inspection	94
Connecting Devices	96
Launching	98
Hand Launching	101
Flight Screen	102
Battery Indicator	103
VIO/GPS Indicator	105
Flight Skills	106
Flying at Night	109
Flying in Precipitation	118
Returning and Landing	129
Hand Landing	130
Hot Sensor Package	132

Postflight

133

Offloading Media	134
Stowing Skydio X10D	136

[Contingency Behaviors](#)

139

Low Battery	140
Lost Connection	141
Lost GPS	143
Reduced Performance State	143
Controller Overheating	144
Emergency Landing and Attitude Mode	145
Flight Termination	148

[Maintenance](#)

149

Replacing Propellers	150
Cleaning Your System	152
Storage	153
Maintenance Schedule	154

[Specifications](#)

156

[Legal](#)

164

Safety Guidelines



WARNING: To avoid injury or damage to your drone, read the Skydio X10D Safety Guidelines in the Safety and Operating Guide.



Keep your fingers away from moving propellers at all times.



Use caution around reflective surfaces (e.g., still water or mirrors) and small obstacles (e.g., thin branches, utility lines, or chain link fencing)

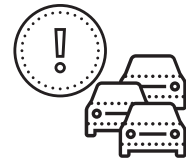

Skydio X10D does not avoid moving objects (e.g., vehicles).



Skydio X10D obstacle avoidance can be impaired when in low light and poor visibility when flying without NightSense. Fly with extreme caution under these conditions.



Before flying over water, ensure your drone has a strong GPS signal. Launch and land over a dry surface.



Skydio X10D is IP55 rated and able to fly in light to moderate precipitation with obstacle avoidance disabled. Skydio X10D Controller is IP54 rated.



Clean all of the cameras before each flight so Skydio X10D can see clearly.

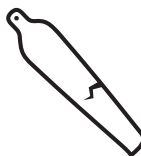

Check your propeller blades for damage before each flight.



Follow all civil aviation authority regulations, as well as all local, state, and federal laws.

Warnings

- Do not operate directly over people and vehicles without following all required regulations and garnering any required Certificates of Waiver or Authorization (COA).
- Fly with extreme caution and care around moving obstacles including but not limited to other aerial vehicles, cars, and/or animals.
- Skydio obstacle avoidance may be degraded around transparent or reflective surfaces, windows, mirrors, or still water greater than 23 in (58 cm) wide. Fly with caution.
- The pilot in command (PIC) is solely responsible for: a) managing altitude, range, and battery level and b) following all civil aviation authority regulations, as well as all local, state, and federal laws.
- Adhere to all in-app alerts, warnings, and recommendations such as landing in clear and safe areas.
- Propeller blades are sharp—handle with extreme caution and care especially when the propeller blades are spinning as serious injury and/or damage may occur.
- Obstacle avoidance is disabled during launching and landing. Exercise extreme caution and care to avoid injury and/or damage.
- When using the flashlight on the VT300-L sensor package, do not stare directly into the light at any range for any extended period of time.
- Ensure your landing area is flat, stable, and clear of obstacles.
- Skydio should not be used or handled by a person under the age of 16 years.
- Never fly near or interfere with crewed aircraft operations.
- Never fly under the influence of drugs or alcohol.

Preflight

- Skydio X10D navigates visually using cameras so it is essential to keep all of the cameras clean. Use the included microfiber cleaning cloth (or a similar type of microfiber cloth) to ensure camera lenses are free of dust and dirt before every flight.
- Ensure all propellers are firmly attached and free of nicks, cracks, or other visible damage. Never fly with damaged propellers.
- Keep your fingers away from spinning propellers at all times.
- Ensure all 4 arms are fully deployed prior to initiating flight. Failure to do so may result in unstable flight and/or a loss of control.
- Skydio X10D uses magnets to retain the battery which may attract metallic debris that could interfere with the connection of the battery to the drone.
 - Prior to installing the battery, inspect the battery connection pins and the battery bay to ensure that they are undamaged and free of debris.
 - Verify the battery is fully seated in the drone prior to launching.
- Do not fly with any batteries with enclosures that are cracked, swollen, gouged, dented, or otherwise substantially physically deformed.
- Safely handle and dispose of any batteries in accordance with all local laws and regulations.
- Batteries should not be stored in extreme environmental conditions.
- Ensure the Skydio X10D Controller has adequate battery life remaining to complete your intended flight.
- Ensure you have set your Return and Lost Connection behaviors before flying.
- Remove the sensor package lock before flying.
- Inspect the chassis and entire drone for damage and debris prior to flight.

Environment

- Skydio X10D is IP55 rated providing protection from limited dust ingress and light to moderate precipitation conditions; it is recommended to not fly in heavy dust conditions or heavy precipitation.
- The Skydio X10D Controller is IP54 rated providing protection from limited dust ingress and light precipitation conditions; it is recommended to not be used in heavy dust conditions or moderate to heavy precipitation.
- Flight in icy conditions is not supported and may result in the loss of your drone.
- Ensure the flight environment has good initial visibility and will have good visibility throughout the duration of the flight.
- Do not hand launch or hand land during windy days, when Low Light flight is enabled, when flying at night, or extreme environmental conditions as serious injury and/or damage may occur.
- Fly cautiously over bodies of water as low relative-altitude flight may degrade or impair autonomous flight performance. Before flying over bodies of water, ensure your drone has a strong GPS signal. Fly at least 10 ft (3 m) above the surface of the water.
 - Failure to acquire strong GPS prior to flight over water may result in erratic flight and/or emergency landing and total loss of the drone.
- Launch and land over dry surfaces. Use extreme caution and care when launching or landing from moving vessels.
- Skydio X10D requires good visibility to retain its obstacle avoidance capabilities. Obstacle avoidance can also be impaired when in low light (without NightSense) and poor visibility. Fly with extreme caution and care under these conditions.
- Skydio does not recommend flying the X10D under the following conditions which can result in serious injury and/or damage including total loss of the drone:
 - Gusts at or above 28 mph (45 km/h)
 - Temperatures less than -4°F (-20°C) or more than 113°F (45°C)
- The Skydio X10D battery features self-warming technology. When flying in temperatures below 32°F (0°C), prewarm batteries before launching. Battery endurance may be degraded when operating near temperature limits below -4°F (-20°C) and above 113°F (45°C).

Flying Safely

- Your Skydio drone only avoids obstacles that are not in motion.
 - Cars, boats, people, animals, drones, crewed aircraft, or other moving objects may not be avoided.
- In the event that your X10D collides with an object, it will attempt to stabilize and continue flying.
- Keep your fingers away from the propellers anytime they are spinning such as during launch, flight, and landing.
- Skydio X10D can't see certain visually challenging obstacles. Do not fly around thin branches, telephone or power lines, ropes, netting, wires, chain link fencing, or other objects less than 0.5 inch (1.3 centimeters) in diameter. This type of crash is not covered under the Skydio Limited Warranty.
- Do not intentionally try to crash Skydio X10D.
- The chassis of Skydio X10D may become hot to the touch in high-temperature environments or direct sunlight, even when powered off. The metal frame may also become hot if powered on while on the ground for long periods of time. Handle with extreme caution and care.
- Do not fly over bodies of water if Skydio X10D indicates a GPS quality warning.
- Exercise extreme caution and care when the sun is low on the horizon as it can temporarily blind the Skydio X10D cameras depending on the angle of flight. Your drone may be cautious or jerky when flying directly toward the sun.
- Skydio X10D may provide an indication, such as displaying an alert to land, if it encounters an issue or determines the environment is not safe for flying. Fly to the nearest safe area and land immediately.
- Flying at high altitudes may significantly increase the time required to return and safely land the Skydio X10D. The pilot is solely responsible for managing altitude, range and battery level at all times.
- Be sure to read/watch all flight tutorials and safety-related materials and pay close attention to any in-app messages.
- Keep your hands on the controller joysticks to maintain control throughout flight.

Flying Safely

- In preparation for landing, stop active autonomous Flight Skills and fly to a clear and stable area. Avoid areas with people, animals, and moving objects. Try to avoid areas with lots of fine pebbles, sand, rocks, or similar materials.
 - The lights on X10D will turn yellow as the drone descends below 10 ft (3 m) indicating that obstacle avoidance is disabled.
 - **WARNING:** Do not attempt to hand catch Skydio X10D before obstacle avoidance is disabled automatically during landing. Attempting to hand catch Skydio X10D while obstacle avoidance is still active will cause it to attempt to avoid your hand and may result in Skydio X10D impacting yourself or another nearby object, resulting in serious injury and/or damage.
 - While Skydio X10D is landing you may nudge the drone forward, backward, left, or right using the Skydio X10D Controller joysticks.
 - Always monitor Skydio X10D during landing and be prepared to use the “nudge” feature or cancel the landing if Skydio X10D is landing in an undesirable location. Use extreme caution and care when landing on elevated platforms, such as the roof of a car or truck, as the Skydio X10D may move laterally to avoid the platform before descending to the 10 ft (3 m) threshold.

Regulations

- You are solely responsible for your Skydio X10D at all times.
- Always follow [FAA](#) and country-specific civil aviation authority regulations, as well as local, state, and federal laws and regulations when operating your Skydio X10D.
- Download the [FAA Drone Safety Guide](#) (if located in the United States).
- Check resources including but not limited to [knowbeforeyoufly.org](#) or apps like [B4UFLY](#) for more information.
- Do not fly in an environment where the use of drones is restricted or not authorized.
- **Maintain visual line of sight at all times**, unless you have received express permission to fly beyond visual line of sight from a civil aviation authority such as the FAA.
- Skydio drones sold in the United States are Remote ID-compliant.



Getting Started

Welcome to your Skydio X10D! Review the basic hardware and accessories that come with your drone before your first flight.

This section covers

Skydio X10D Starter Kit

Skydio X10D Hardware

Skydio X10D Controller Hardware

Skydio Autonomy Features

Charging

Skydio X10D Starter Kit

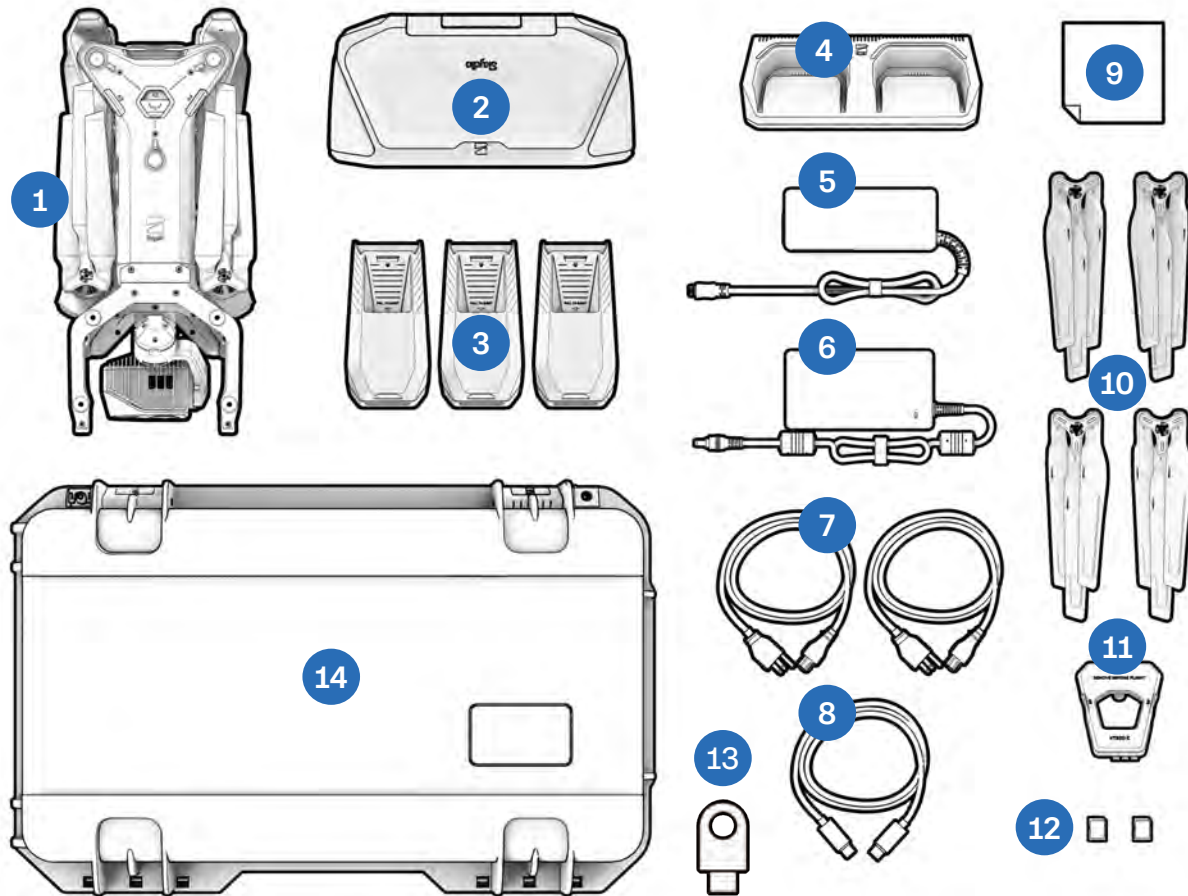

1. Skydio X10D and sensor package
2. Skydio X10D Controller with chosen Skydio Connect option
3. Batteries (3)
4. Skydio X10D Dual Charger
5. 100 W power supply (USB-C)
6. 230 W fast power supply (barrel jack)
7. Power cables (2)
8. USB-C to USB-C pairing cable
9. Microfiber cleaning cloth
10. Spare propeller sets (4)
11. Sensor package lock
12. 256 GB microSD cards, pre-installed (2)
13. Encryption Key
14. Starter Case (hard shell)



Scan for more information about the kits available for purchase.

Skydio X10D Starter Case Layout

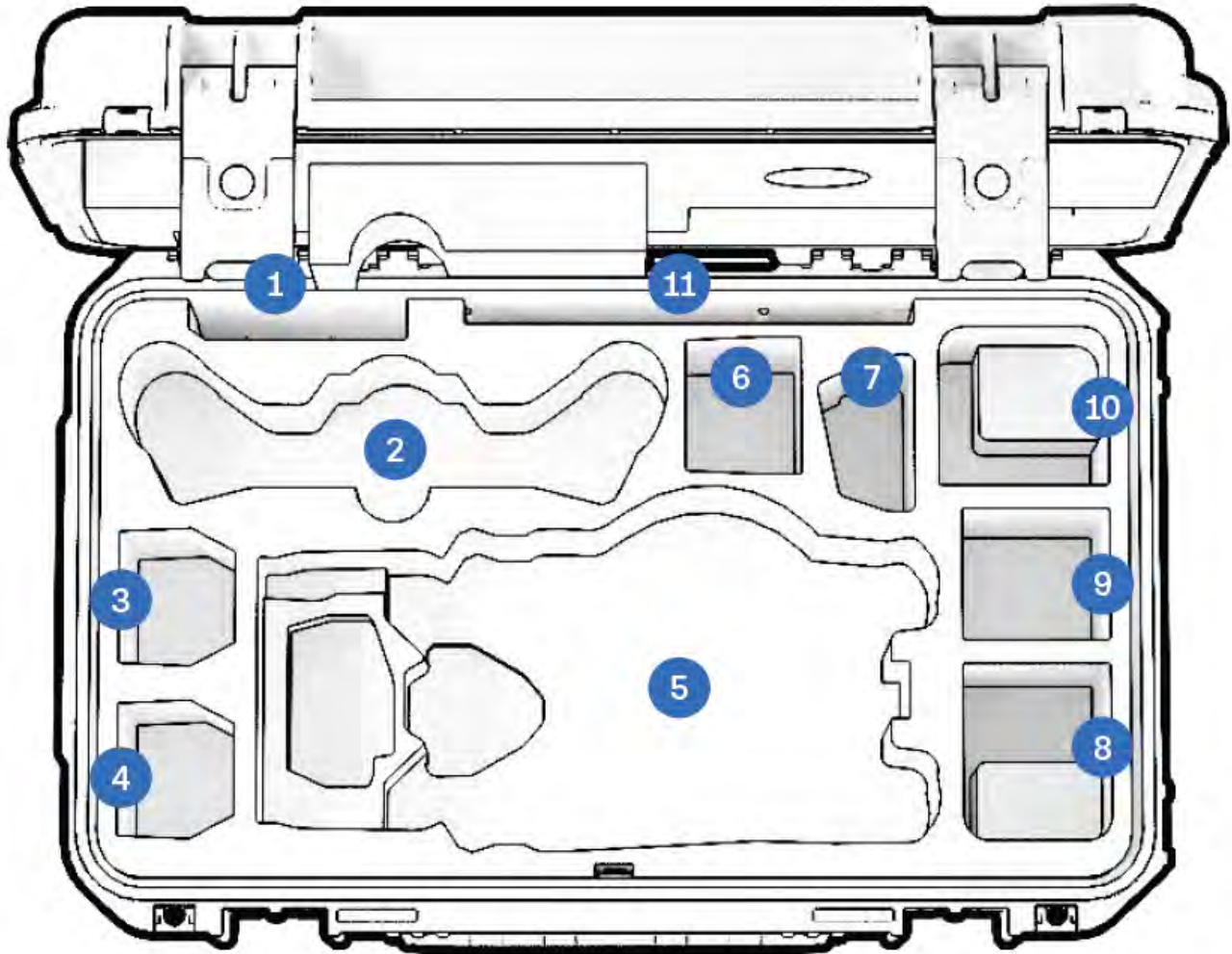

1. Propellers
2. X10D Controller
3. X10D Battery
4. X10D Battery
5. Skydio X10D Drone
6. Flex space: X10D Battery or 100W Power Supply
7. X10D Dual Charger
8. Flex space: 100W Power Supply or Attachment
9. Flex space: Attachment or 100W Power Supply only (battery not recommended)
10. Flex Space: 230W Power Supply or Attachment
11. Quick Start Guide and other documents

Skydio X10D Hardware

1. Chassis
2. Arm (4)
3. Sensor package
4. Sensor package frame
5. Log and Media card slots (2)
6. Top navigation cameras (3)
7. Top attachment bay (A2)
8. Side attachment bay (A3, A4)
9. Bottom navigation cameras (3)
10. Bottom attachment bay (A1)
11. Time of flight sensor
12. Parachute strap location (optional attachment)

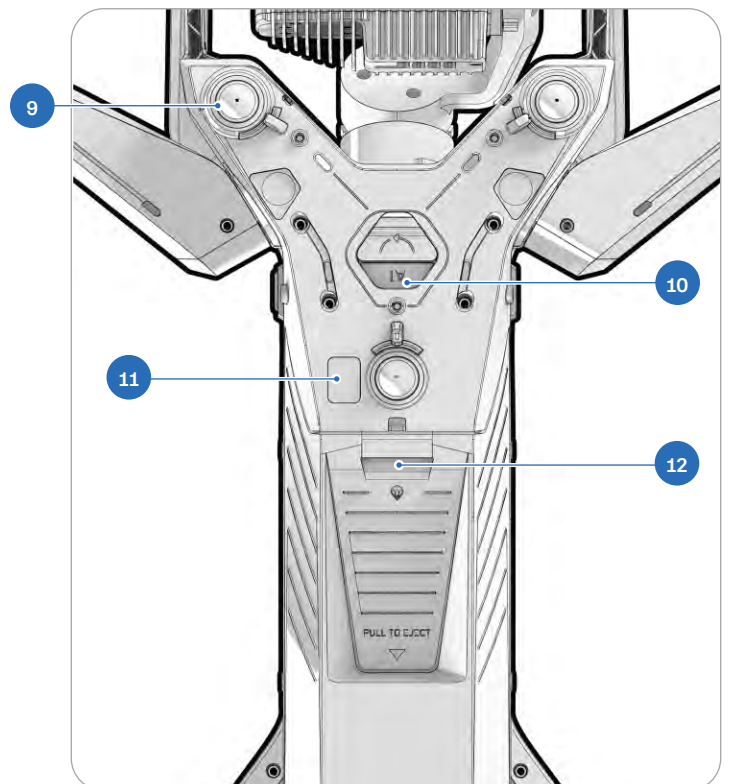
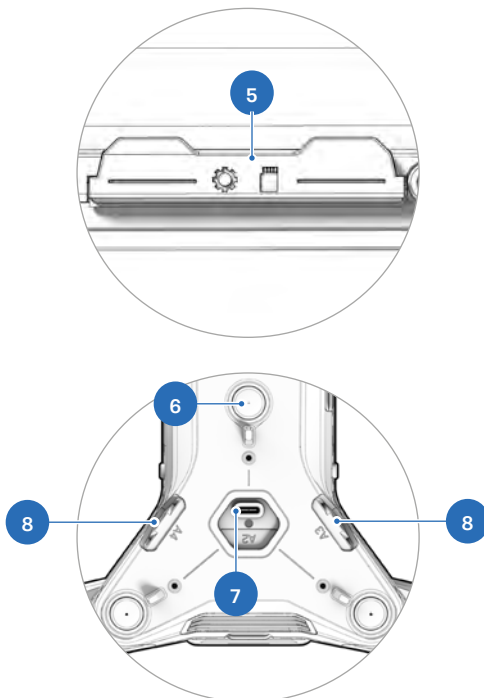
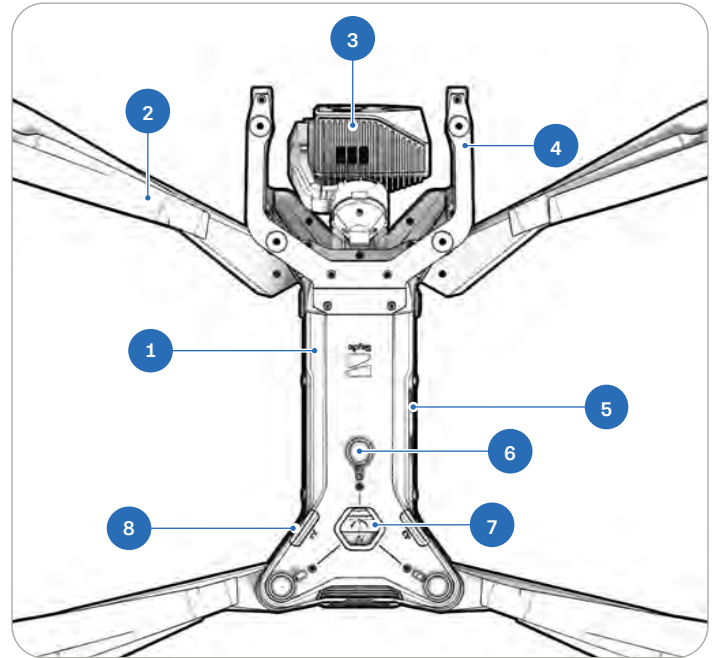

Getting Started

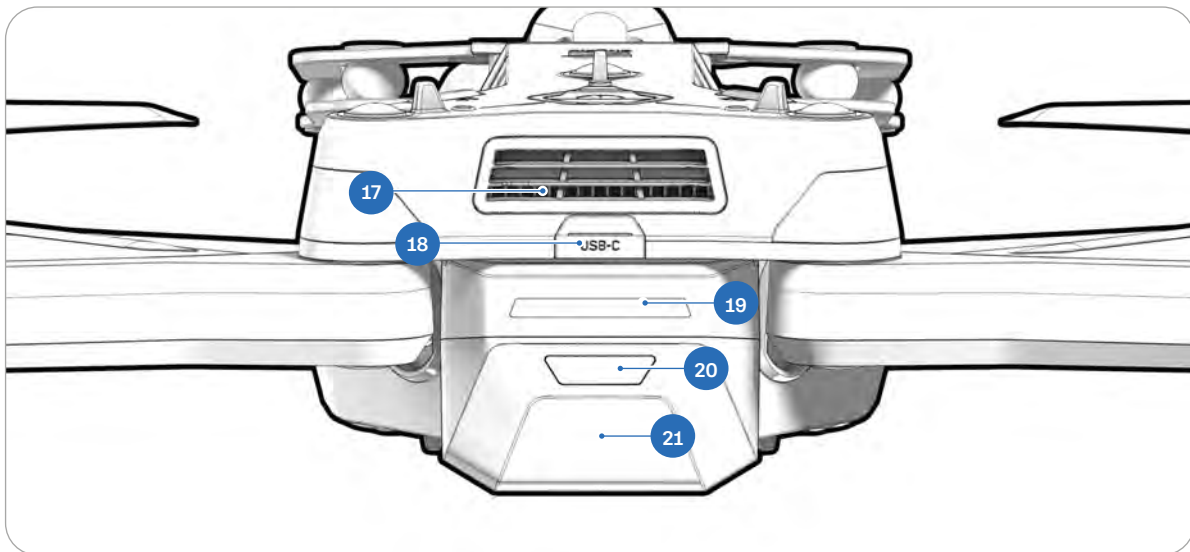
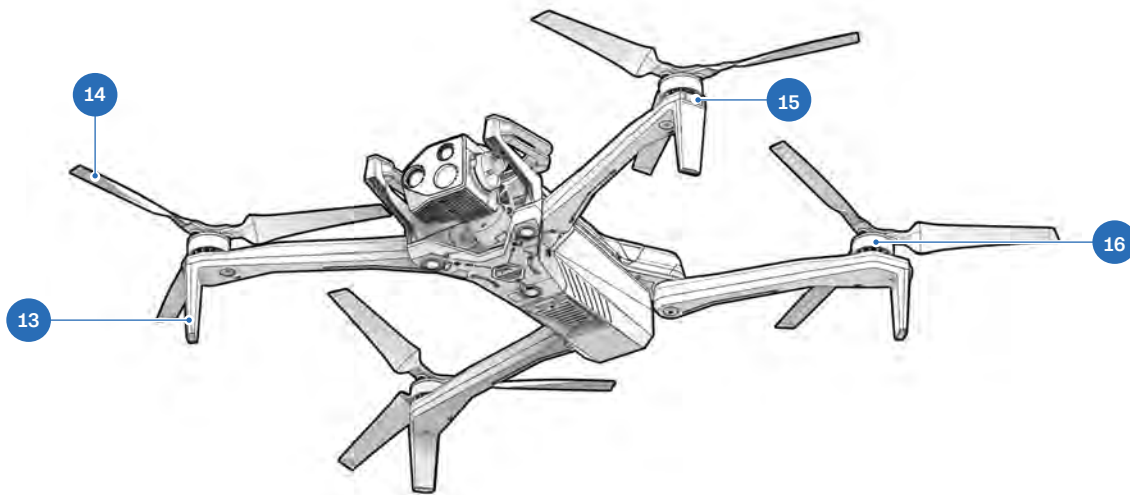

13. Landing feet/antennas

14. Propeller blades

15. RGB/strobe lights

16. Propeller motors

17. Cooling fan/outlet

18. USB-C charge port

19. Battery lights

20. Power button

21. Battery



Scan for more information about the sensor packages available for purchase.

Skydio X10D Controller Hardware

1. Left joystick
2. Menu/Back button
3. C1 button¹
4. C2 button¹
5. C3 button¹
6. Power button
7. Launch/Return/Land button
8. Pause button
9. Directional pad (D-pad)
10. Right joystick
11. Controller cover/antennas
12. R1 button (Shutter)
13. Right wheel
14. HDMI port
15. USB-C charge port
16. L1 button (Boost)
17. Left wheel¹
18. R2 button¹
19. Cooling fan
20. Neck strap² and tripod mount
21. L2 button¹

¹Customizable

²Neck strap sold separately

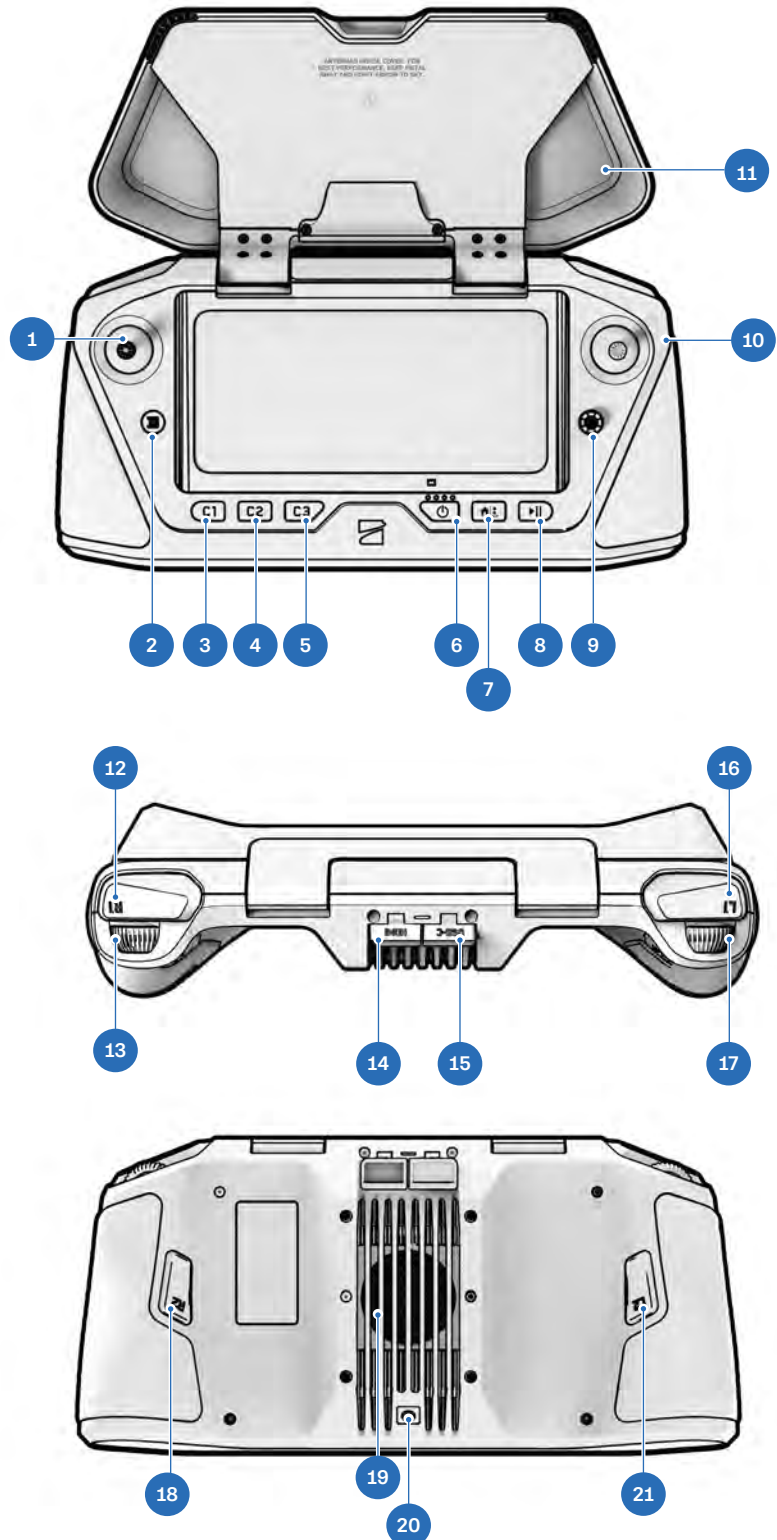

Skydio X10D Autonomy Features

With the purchase of Skydio X10D, you have access to a powerful suite of advanced AI-pilot assistance capabilities.

Skydio X10D comes equipped with the following software features:

Skydio Autonomy Package

- 360° Obstacle Avoidance
- Attitude Mode
- Crosshair Coordinates
- Low Light Flight
- Manual Flight
- Map Capture
- Motion Planning
- Object/Scene Recognition
- Offline Maps Importing
- Point of Interest Orbit
- Real-time 3D mapping
- Skydio Visual Navigator
- Subject Detection
- Track in Place (subject tracking)
- Visual Return-to-Home
- Waypoint Missions
- Zoom

Charging Skydio X10D Batteries

Skydio X10D batteries are shipped in a state of hibernation and will not power on your drone out of the box. Your batteries will automatically exit this state once they begin charging for the first time.

Using the Skydio X10D Dual Charger

The Skydio X10D Dual Charger sequentially charges two batteries. The Dual Charger will prioritize fully charging the battery with the highest charge level. If both batteries are depleted, it will prioritize the battery that is inserted first.

Step 1 - Remove battery from drone

Skydio X10D batteries are held in place using a magnetic connection.

1. Firmly grip the drone chassis with one hand
2. Grip the battery with your other hand, placing your palm over the power button and wrapping your thumb under the battery
3. Using your fingers as leverage, press against the drone until the magnets disengage and slide the battery away from the sensor package



Getting Started

Step 2 - Place batteries into the X10D Dual Charger

Ensure the battery and connection pins are free of debris and interference. Gently push down to ensure the batteries are properly seated.

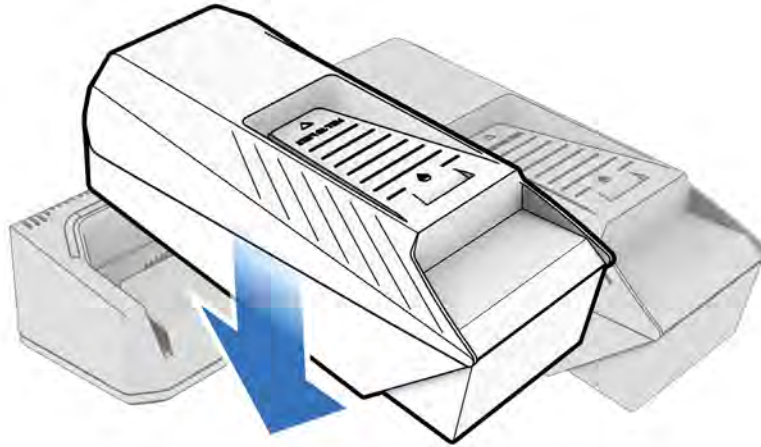

Step 3 - Insert the power supply

Two charging ports are located on the back of the Skydio X10D Dual Charger. You may use either the 100 W USB-C power supply or the 230 W fast power supply.

Plug into a power source.

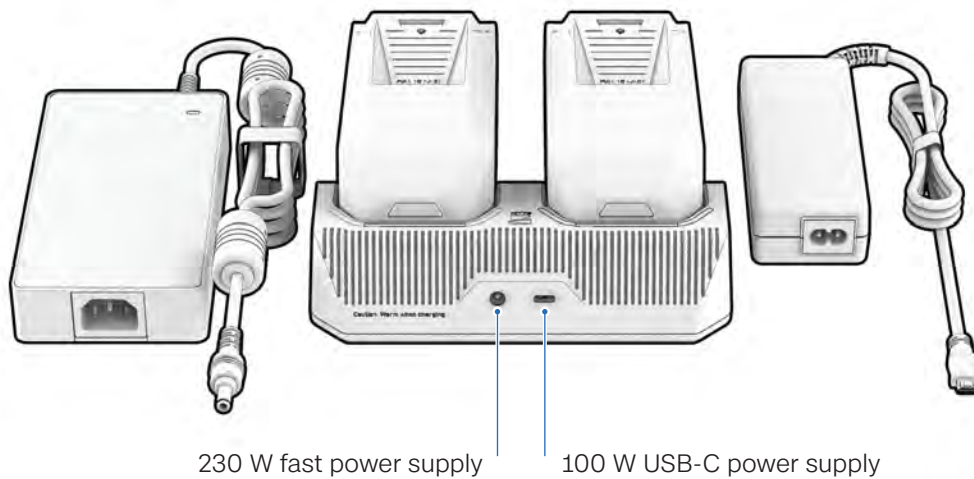

Getting Started

Battery Charge State

Light Behavior on X10D Dual Charger

Actively charging	Pulsing blue
Waiting to charge	Solid blue
Charging complete	Solid green

Power Supply

Input

Charge Time

230 W	20VDC, 11.5A	About 1 hour to charge a depleted battery
100 W	5-20VDC, 3A / 20VDC, 5A	About 1 hour 45 minutes to charge a depleted battery



CAUTION: *Third-party adapters and cables are not supported. Only use the Skydio-provided power supplies and cables to charge your batteries.*



NOTE: *Pass-through charging is not currently supported. This functionality will be enabled in a future software update.*

Using Skydio X10D

Step 1 - Insert battery

Align the battery with the rails and slide toward the sensor package until the magnets engage.

- Ensure the battery and rails are free of debris and interference
- Ensure the battery is completely seated before flying



Step 2 - Locate the charging USB-C port

The charging port is located on the back of the drone above the battery. This is the only USB-C port that supports charging.

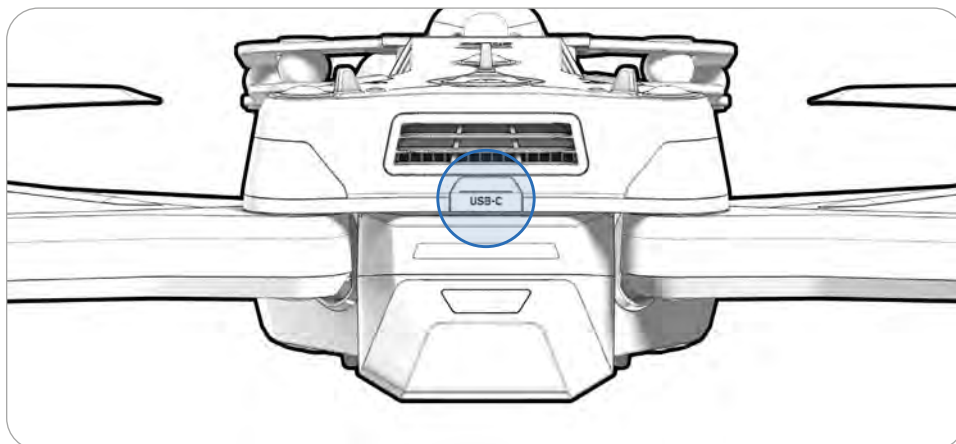

Getting Started

Step 2 - Insert the 100 W power supply

Plug into a power source.

- It will take about 2 hours to fully charge a depleted battery using the 100 W power supply

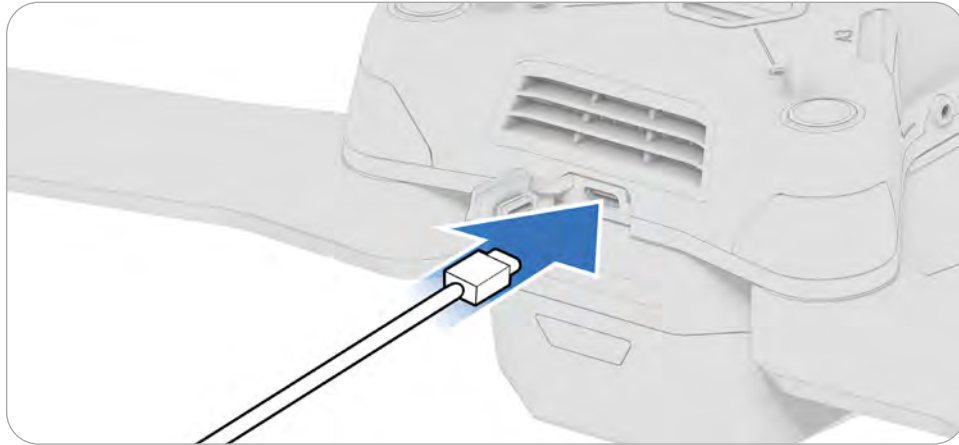

Charging the Skydio X10D Controller

Step 1 - Locate the USB-C port

The charging port is located on the back of the controller.

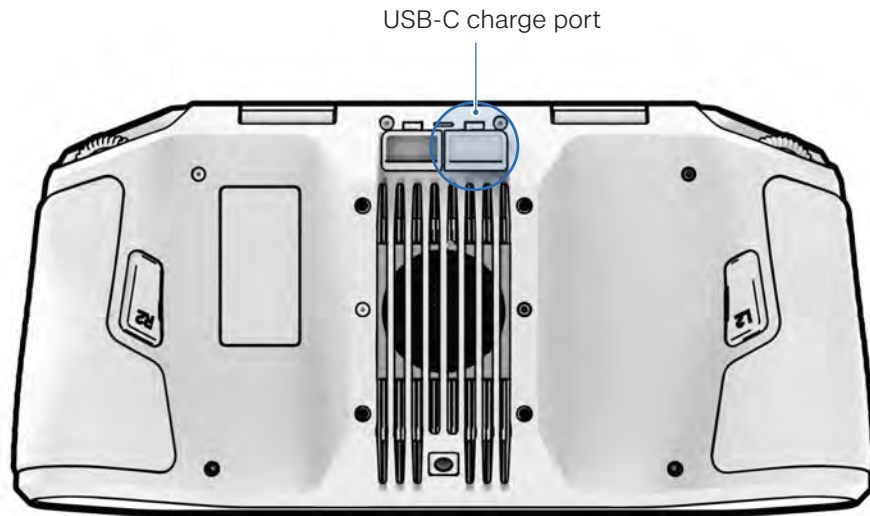

Step 2 - Insert the 100 W power supply

Connect your Skydio X10D Controller to the 100 W power supply. Plug into a power source. The lights on the front of the controller will turn on and indicate the level of charge.

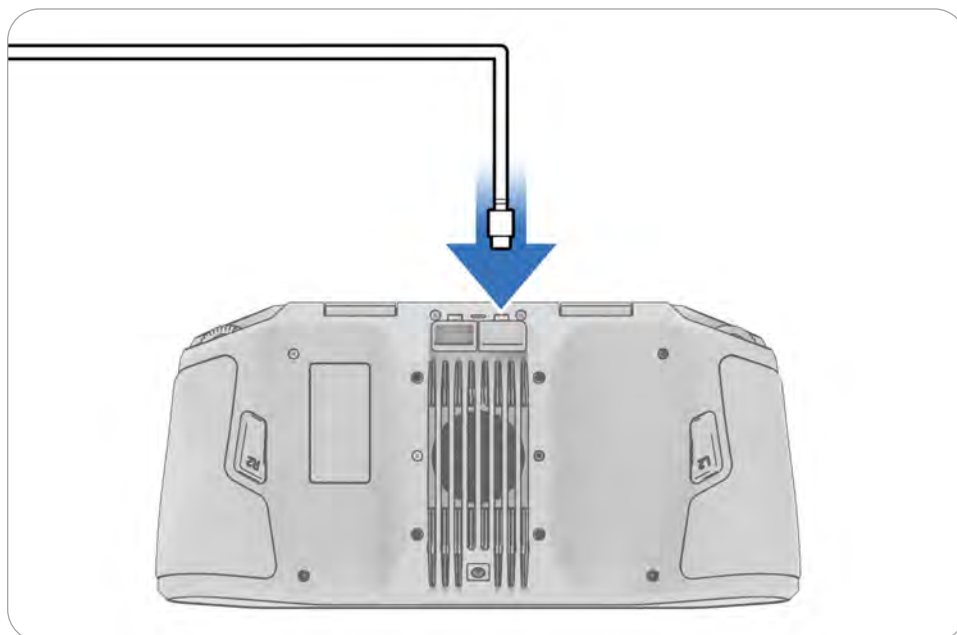

Finding Drone Name and Battery Serial Number

Skydio X10D UAV Name

This begins with **SkydioX10D** and can be found on the label inside the battery bay of the drone.

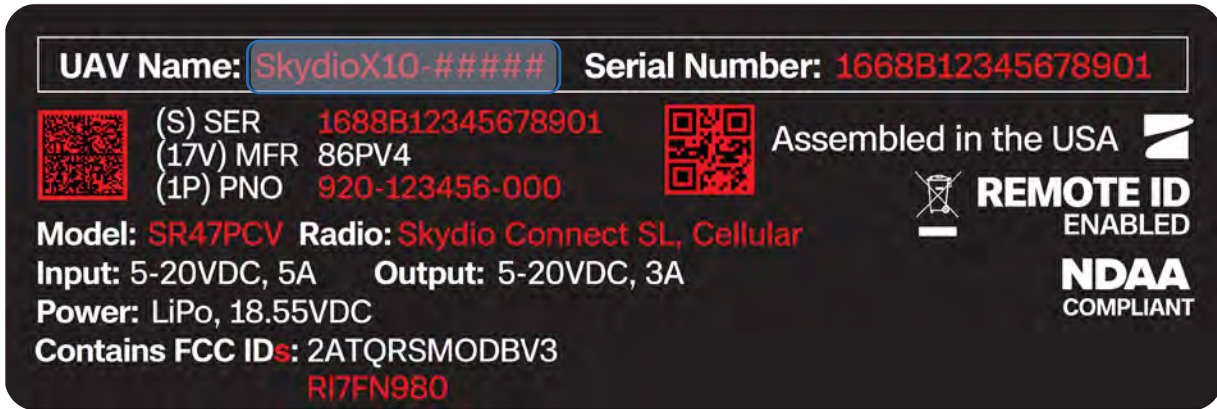

Skydio X10D Battery Serial Number

This 16-character number begins with **P208904** and can be found on the battery label below the QR code.



INFO: After an initial flight, you can also find the battery serial number listed in the Battery column under **Reports > Flights**.





Preflight

Set up your system before your first flight.

This section covers

Skydio X10D Setup

Skydio X10D Controller Setup

Updating the Skydio X10D System

Encryption

Importing Maps

Battery Warming in Cold Environments

Skydio X10D Setup

Step 1 - Unfold the rear arms

Hold the drone with the sensor package facing away from you. Pull **laterally** away from the chassis until you feel the arm seat into place.

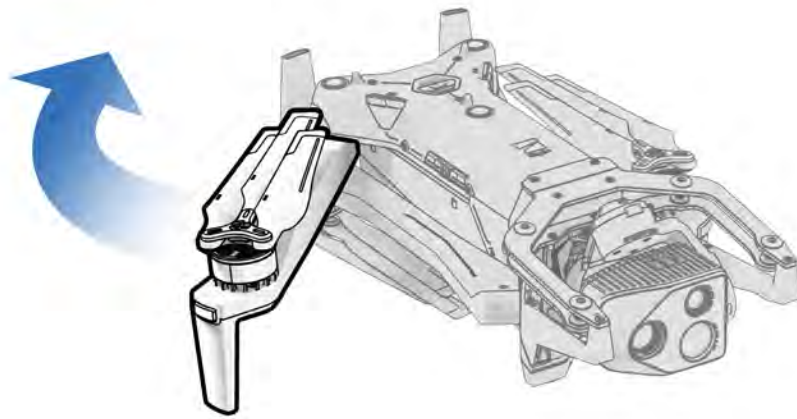

Step 2 - Unfold the front arms

Push **down** and **forward**. Gently continue until you feel the arm seat into place.

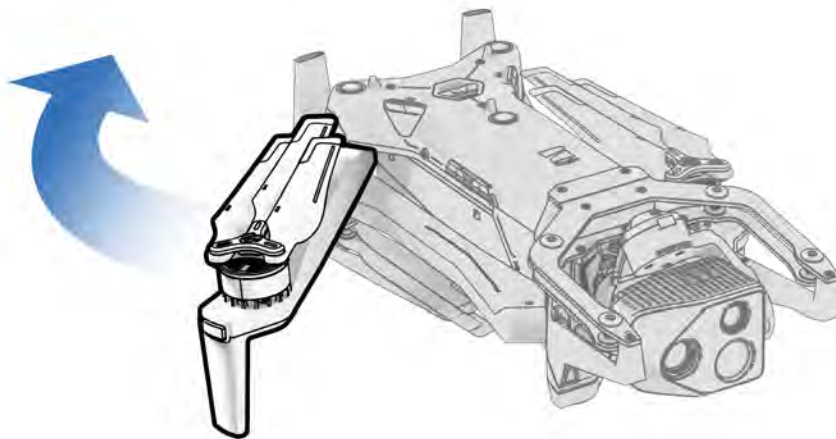

Step 3 - Verify and format microSD cards (pre-installed)

Ensure you have two UHS Speed Class 3 (or faster) microSD cards inserted in the slots on the side of the drone.

- Minimum 256 GB
- Format your cards before flying using **Manage Data** within the **Information** menu (**Global Settings > Information > Devices > Manage Data**)

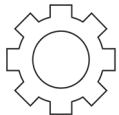

Logs card

Scan data and records flight logs



Media card

Stores media captured during flight

Preflight

Step 4 - Insert battery

Align the battery with the rails and slide toward the sensor package until the magnets engage.

- Ensure the battery and rails are free of debris and interference
- Ensure the battery is completely seated before flying



Step 5 - Remove the sensor package lock

Hold the sensor package and gently pull to remove from the top of your drone.

- Save this piece to reattach when storing or transporting

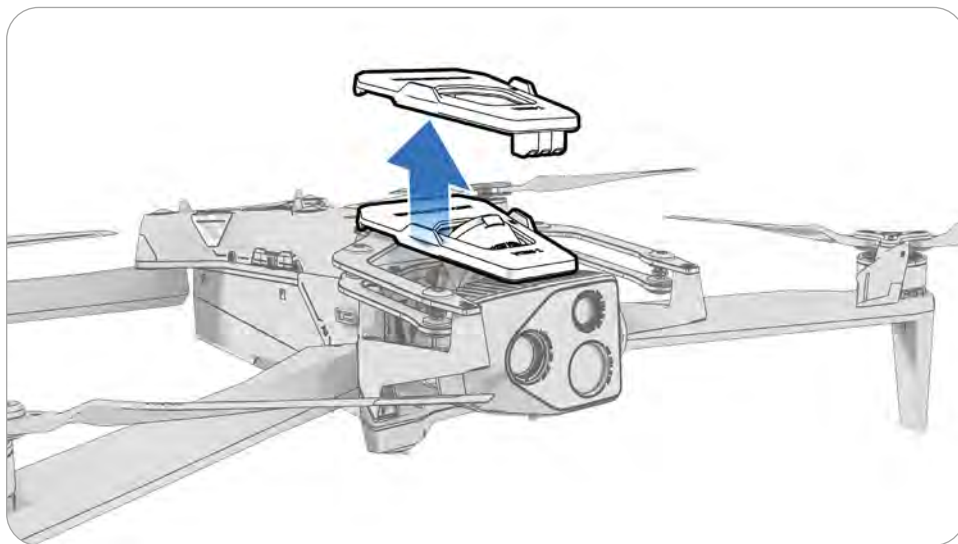

Skydio X10D Controller Setup

Step 1 - Power on the Skydio X10D Controller

Open the controller lid and hold the Power button for five seconds. The lights on the front of the controller will turn on and indicate the level of charge.

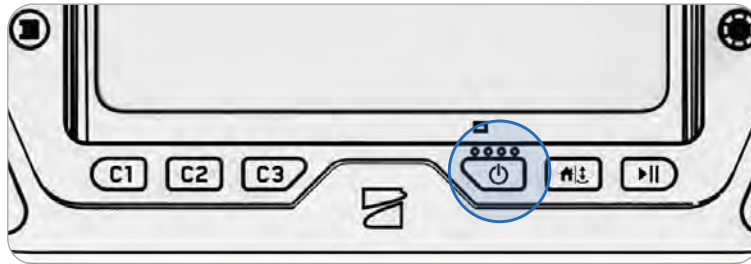

NOTE: While powered off, you can check the level of charge by pressing the Power button once.

Step 2 - Set up Skydio Flight Deck

Skydio Flight Deck is the dedicated flight software on your controller. Follow the on-screen prompts to begin setup.

- Follow the on-screen prompts to begin setup.
- Create a device password to unlock the controller
- The password will be required to unlock the controller when powering on or waking from a sleep state
- Follow your organizations guidelines for password length and complexity



CAUTION: The password cannot be recovered or reset. Ensure that your password is entered correctly and is written down and stored in a safe location. If the password is lost, the controller will need to be replaced.

Preflight

Step 3 - Power on Skydio X10D

Press and hold the Power button on the battery for three seconds. The lights on the drone arms will turn blue as X10D powers on.

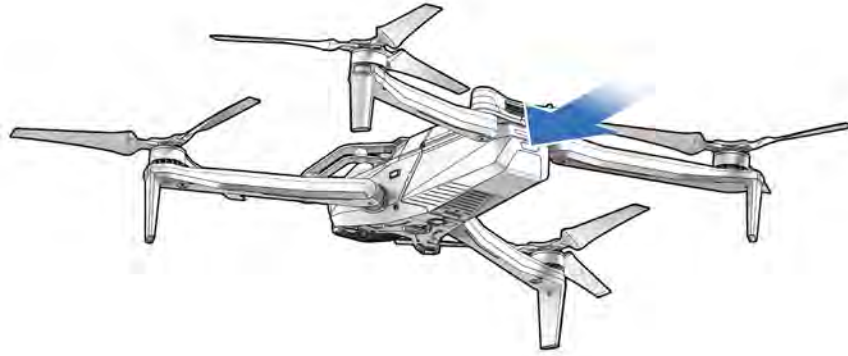

Step 4 - Pair the drone and controller

Use the USB-C pairing cable to connect your devices. Wait as pairing completes. The lights on the drone will turn solid blue and the name of your drone will appear on the screen when pairing is successful.

Once paired, the drone and controller will automatically connect before future flights.

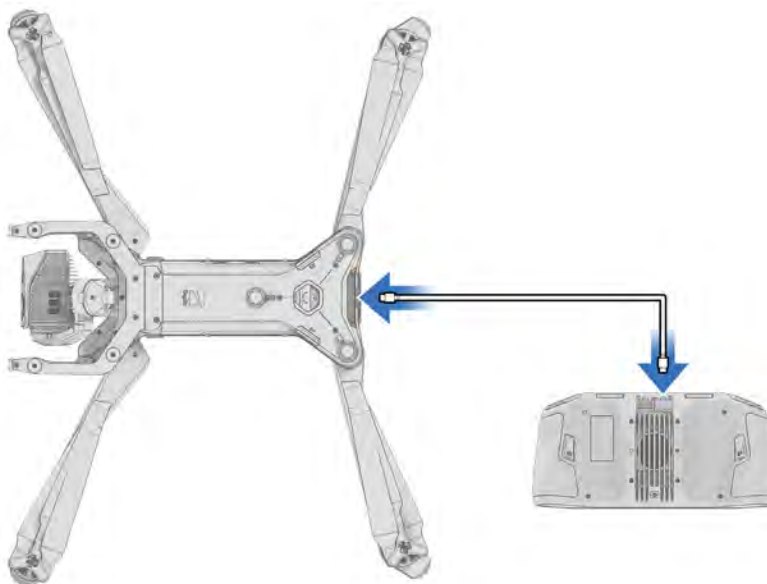

Updating the Skydio X10D System

Step 1 - Access the files from Skydio Fleet Manager for Offline Drones

- .zip file which is the update for your X10D vehicle
- .tar file which is the update for your Skydio X10D Controller

Step 2 - Generate the .zip file and download the .tar file

Step 3 - Insert a memory drive into your computer

Step 4 - Copy the offline_ota folder and the .tar file into the root level of your memory drive

- So that they are not contained inside any other folders
- Safely eject the memory drive from your computer

Step 5 - Insert the memory drive into the rear USB-C port on the vehicle

Step 6 - Power on the vehicle

- The update will begin automatically
- The lights on your drone will begin to display the update status:

Update Status	Light Feedback
Initializing	Solid yellow
0-25%	1 arm flashing yellow light
25-50%	1 arm solid yellow / 1 arm flashing yellow
50-75%	2 arms solid yellow / 1 arm flashing yellow
75-100%	3 arms solid yellow / 1 arm flashing yellow
Complete	4 arms solid green light
Error	Flashing red

Preflight

Step 7 - Power on your controller

Step 8 - Select the Information menu

Step 9 - Select Controller Update

Step 10 - Insert the memory drive into the USB-C port on your controller

Step 11 - Select Update

- Navigate to the memory drive root folder
- Select the update .tar file

Step 12 - Select Done

- The update will begin automatically
- Allow up to five minutes for the update to complete
- During this process, your controller may restart multiple times

Step 13 - Verify that the version numbers matches the version numbers provided by Skydio

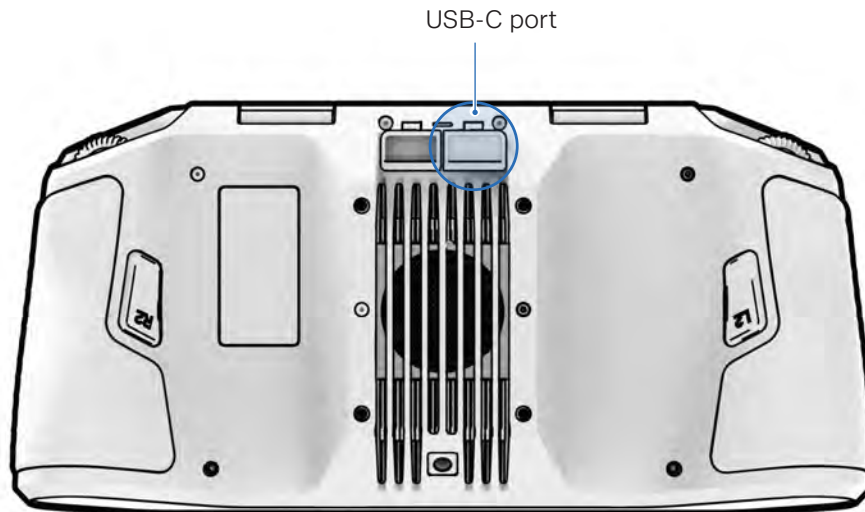

Encryption

An encryption key that enables you to encrypt your media is included with your Skydio X10D. You will need to pair that Encryption Key to your X10D and store it with your vehicle. You can enable and disable the encryption settings in the Skydio X10D Controller Flight Deck. When the media encryption is enabled, all images and videos captured by X10D will be encrypted and hidden in the Media Review tab.

To enable encryption:

Step 1 - Power on and pair the Skydio X10D and controller

Step 2 - Insert the Encryption Key into the rear USB-C port on the X10D

- The Encryption Key lights will begin blinking and a notice will alert you to remove the key

Step 3 - Select Global Settings >

Information menu > your drone name

Step 4 - Select Encryption and Enabled

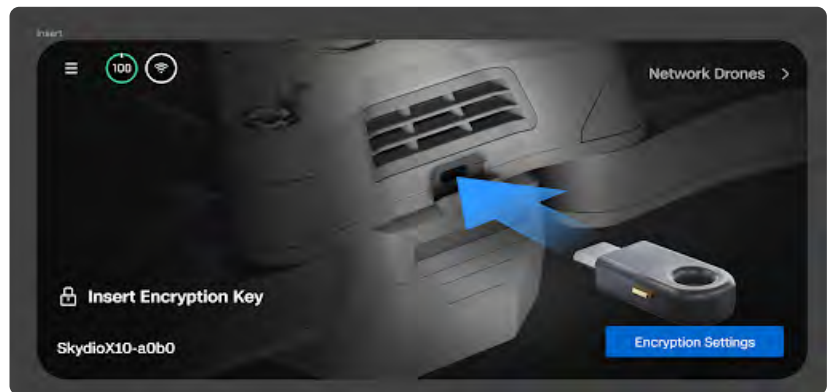

To disable encryption:

Step 1 - Select Global Settings >

Information menu > your paired drone

Step 2 - Select Encryption and Disabled

- If Disable Encryption is selected, all media captured will not be securely encrypted. You will be able to review your media in the Media tab.

To Decrypt media to view and transfer to your device:

Step 1 - Insert the Encryption Key into the rear USB-C port on the X10D

- The Encryption Key lights will begin blinking

Step 2 - Remove the Encryption Key when the lights stop blinking

Step 3 - Attach one end of the USB-C cable to the rear USB-C port on the X10D

Step 4 - Attach the other end to your device and import your decrypted media

- Windows OS will recognize X10D as an external hard drive
- Mac OS will utilize the Photos app or Image Capture app to transfer media



WARNING: Pairing an Encryption Key assigns the key to that X10D. It is essential that you store the Encryption Key with the X10D. Using a different Encryption Key will overwrite the original pairing, erasing the previously captured media.

Importing Maps

Import DTED, MOBAC, Quantum GIS, GeoTIFF, custom QGC, and Mapbox tiles to the Skydio X10D Controller using a USB-C memory drive or SD memory card reader.

Step 1 - Load your map files onto a USB-C flash drive or SD memory card

- Ensure that the SD memory card is formatted to exFAT
- Insert the USB-C drive or adapter into the controller
- Select the Information menu and Import Maps

Step 2 - Select Maps

- Navigate to the storage device
- Select the maps to import

Step 3 - Select Done

- Wait for your maps to import
- Select View Map Library to review your imported maps

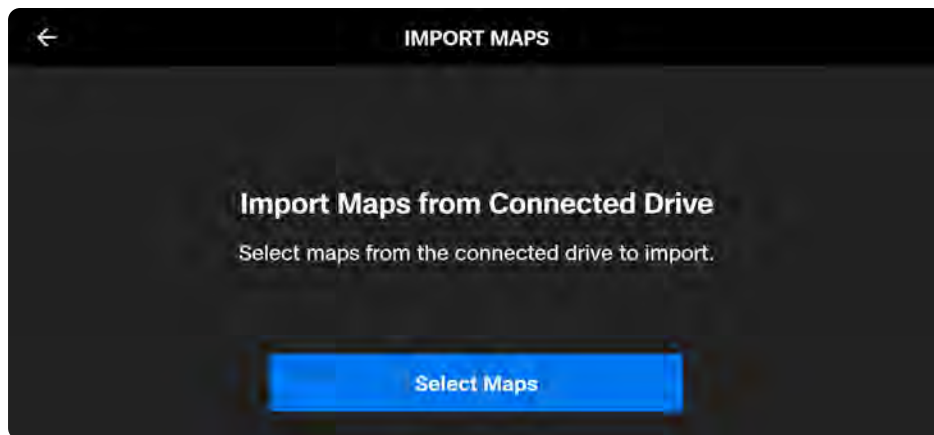

Set the Skydio X10D controller to Online mode to connect to a WiFi network. Toggle on to access updates, download maps, and stream a live video feed. Toggle off to retain flight security. Visit [How to access the WiFi on your Skydio X10D controller](#) for detailed information.

Battery Warming in Cold Environments

For extremely cold environments, the Skydio X10D battery features self-warming technology to enable flight within 5 minutes.

If the X10D battery is below 32°F (0°C), Skydio X10D will be prevented from launching. You will need to pre-warm your batteries before you can launch.

- Battery self-warming is supported down to -4°F (-20°C).
- Skydio X10D will allow launching with reduced performance while continuing to operate the self-warmer until full performance is restored.
- A battery must have at least 30% charge to self-warm.
- A fully charged battery is strongly recommended when flying in cold weather.
- Flight time will be reduced in cold temperatures.
- Minimize aggressive maneuvering in extremely cold environments.

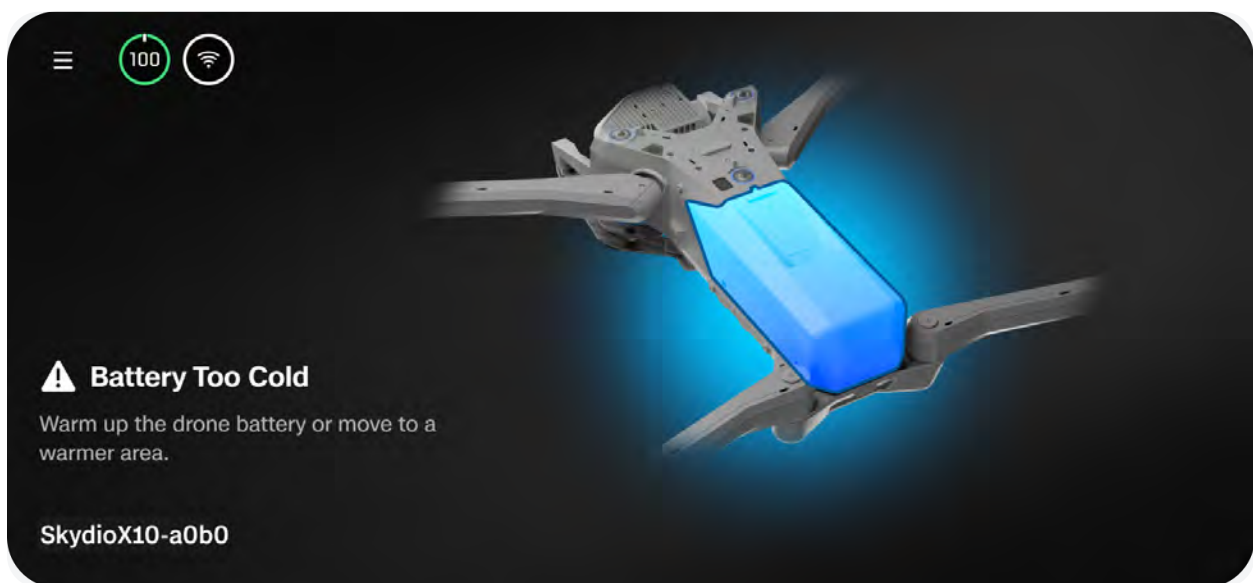

Pre-warming Skydio X10D Batteries

If Skydio X10D detects that a battery is too cold to launch, the battery will automatically begin self-warming. Launch will become unblocked when the battery is sufficiently warmed for the given state of charge.

You also have the option to prewarm a battery before inserting into the drone:

Step 1 - Triple tap the battery button to begin the self-warming process

- The lights on the battery will turn orange during the self-warming process
- Triple tapping again will end the self-warming process

Step 2 - If the battery is cold enough it will begin self-warming

- When self-warming is complete, the lights on the battery will briefly turn blue and then power off

Step 3 - Insert the battery into the drone and power on

- If the self-warming was still in progress prior to inserting, it will continue while the battery is in the drone
- Launch will become unblocked when the battery is sufficiently warmed for the given state of charge



Skydio Flight Deck

Skydio Flight Deck is the dedicated flight software on your controller. In this section you will learn about core menu locations and setting customizations.

This section covers

Gate Screen

Global Settings

Flight Controls

Return Behaviors

Sensing (Obstacle Avoidance)

Display

System Status

Quick Actions

Gate Screen

After powering on and connecting to your drone, the first screen you will see is the **Gate Screen**. This screen is the first step to starting your flight, switching modes, or configuring preflight settings.

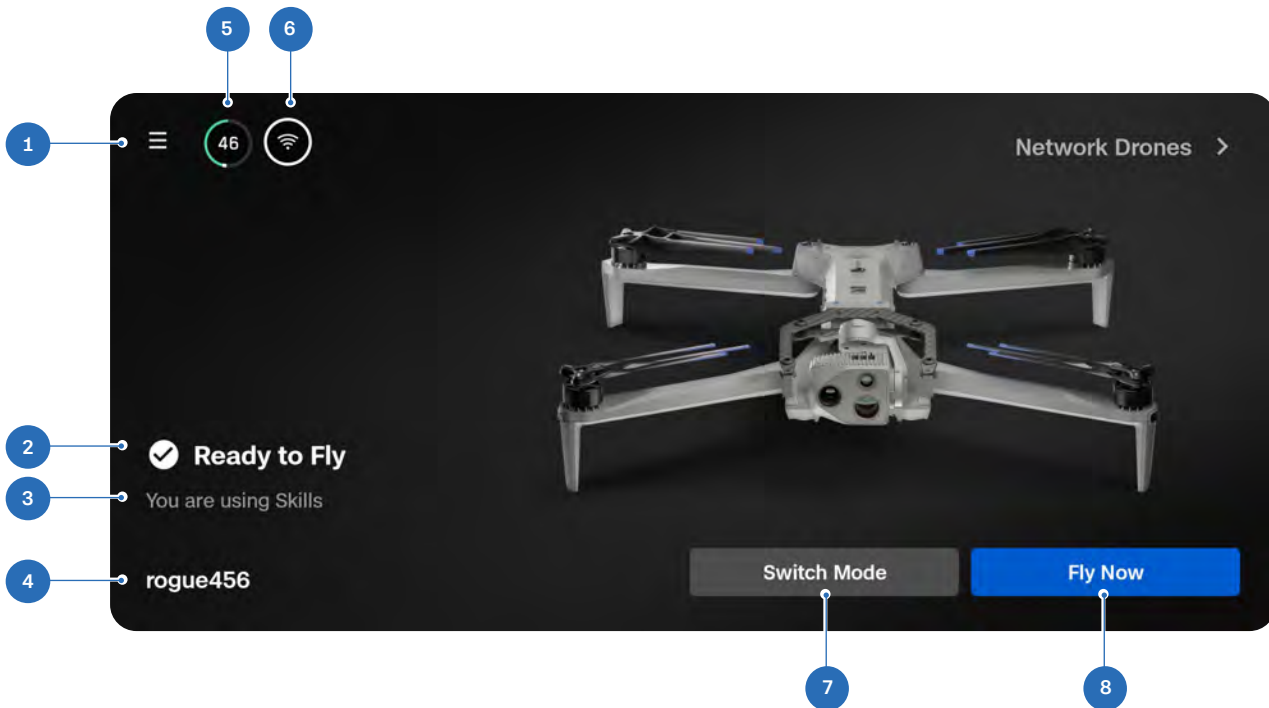

- 1. Global Settings
- 2. Flight Status
- 3. Flight Mode
- 4. Drone Name

- 5. Drone Battery Level
- 6. Signal Strength
- 7. Flight Mode Selector
- 8. Fly Now (Flight Screen)

Global Settings

The Global Settings menu is accessible before and during flight. You will use this menu to navigate to a variety of settings, such as low battery behaviors, stream layouts, and obstacle avoidance behavior.

Select the Global Settings icon in the top left of the screen to access the following menus:

- Media
- Information
- Flight Controls
- Sensing
- Return
- Lighting
- Attachments*
- Connection
- Radio
- Display
- System Status

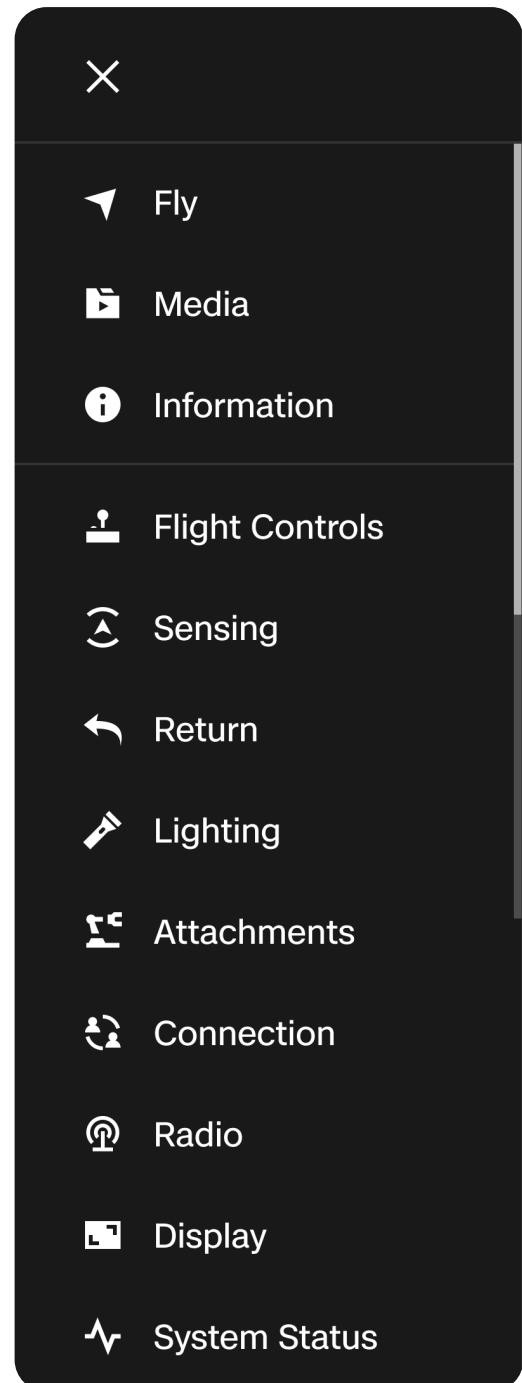

**Attachments coming soon*

Media

Use this menu to view photos, videos, and scans from your recent flights.

- Select an image or video to view
- Press and hold on a thumbnail to select multiple or delete

If you captured photos using **Interval**, all photos captured will appear as a single stack. Selecting the stack will allow you to scroll through individual images one by one.

Only standard color and thermal JPGs will display in the Media menu. To access your DNG or RJPG files, you must transfer the files from your drone.

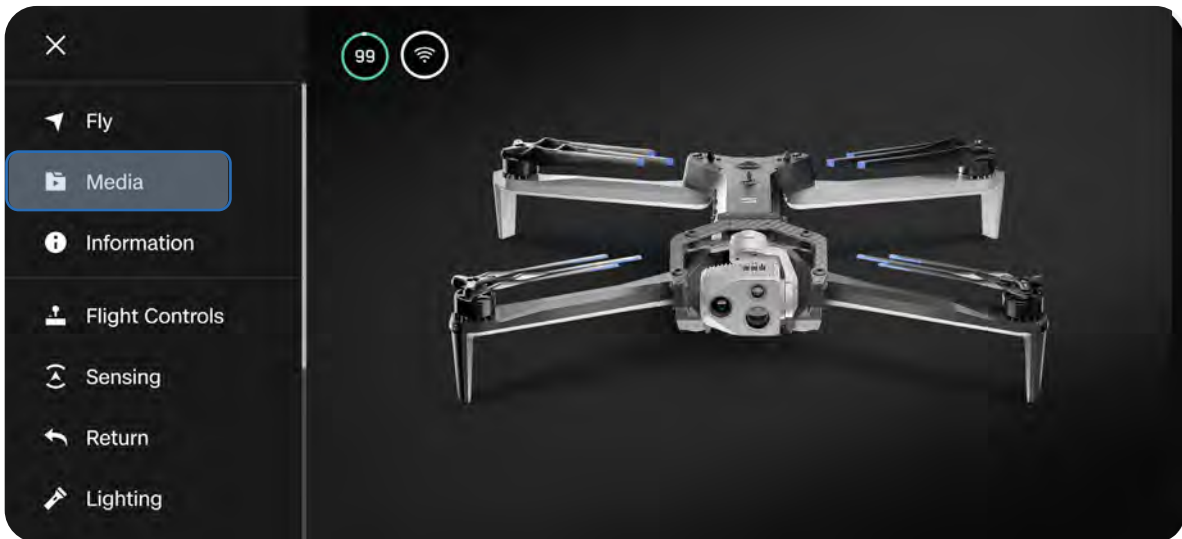

NOTE: Media is not accessible inflight.

Information

While you are connected to Skydio X10D, the Information menu provides access to settings, radio frequency selections, the map library, and more.

Devices

Lists the name of the drone that is currently connected, as well as other X10D drones that have previously paired to the controller.

Verify software versions by selecting the name of a drone.

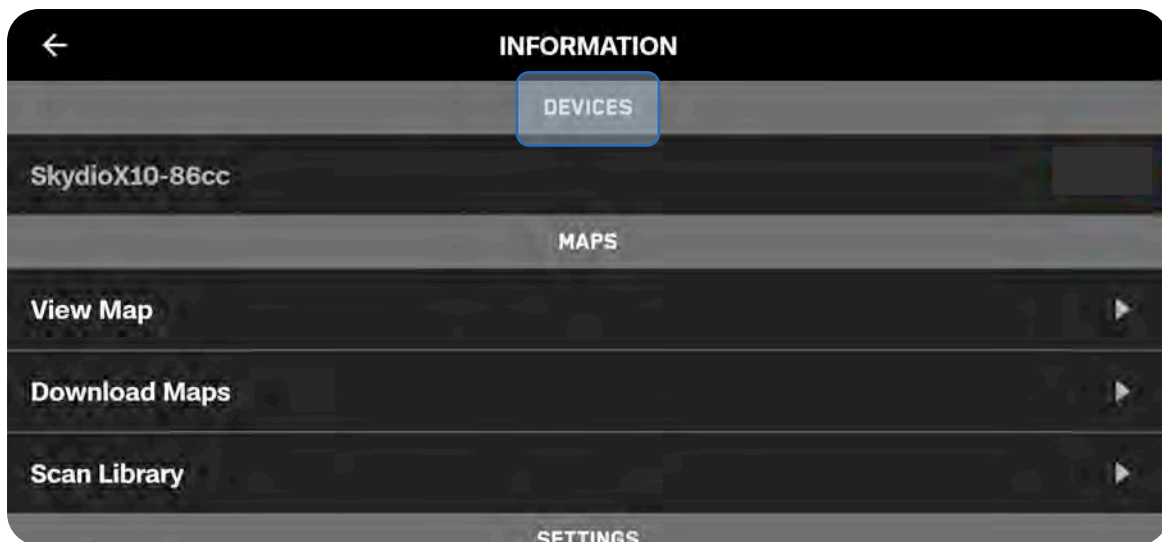

Skydio Flight Deck

Manage Data

Select to format the Log and Media cards or Factory Reset your drone.

Locate Skydio X10D

In the event that your Skydio X10D is lost, you may view its last known location. If the Coordinate setting is enabled, the latitude and longitude of the current or last known location will be displayed.

View Last Flights

Displays the feed that was last viewed from the Flight Screen, even if the drone is not connected. Designed to assist you with locating your drone in the event of a crash, emergency landing, or low battery landing in an unintended location.

Export Files

Export flight logs and telemetry data.

Overwrite Media

Manage your media storage by automatically deleting old media to ensure you always have enough storage space to start a new flight. Select Delete Oldest Media to automatically delete the oldest media stored on the microSD memory card.

Anti-flicker

Adjust anti-flicker settings if you experience flickering in your video. This setting is for users located outside of North America, in countries where the frequency of the alternating current in household electrical outlets is 50 Hz.

Maps

View Map

View your current location, search, and configure map settings.

The location of Skydio X10D, the controller, Launch Point, and Home Point (if set) are all indicated on the map.



Skydio X10D



Controller



Launch Point



Home Point

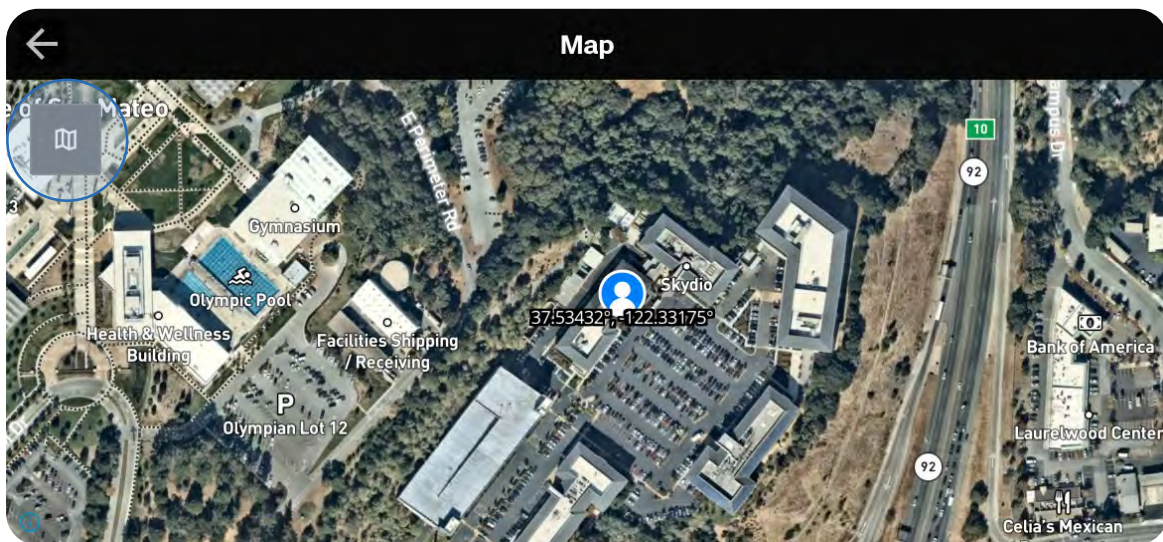

Skydio Flight Deck

Waypoint Mission

Stores the most recent Waypoint Mission. Press and hold on a waypoint to delete it. Press and hold on the map to add a waypoint or delete all waypoints.

Only one Waypoint Mission will be saved at a time.



Skydio Flight Deck

Scan Library

View or repeat saved Map Capture scans. You also have the ability to import a previous Map Capture.



INFO: For more information, visit [How to use Map Capture](#).

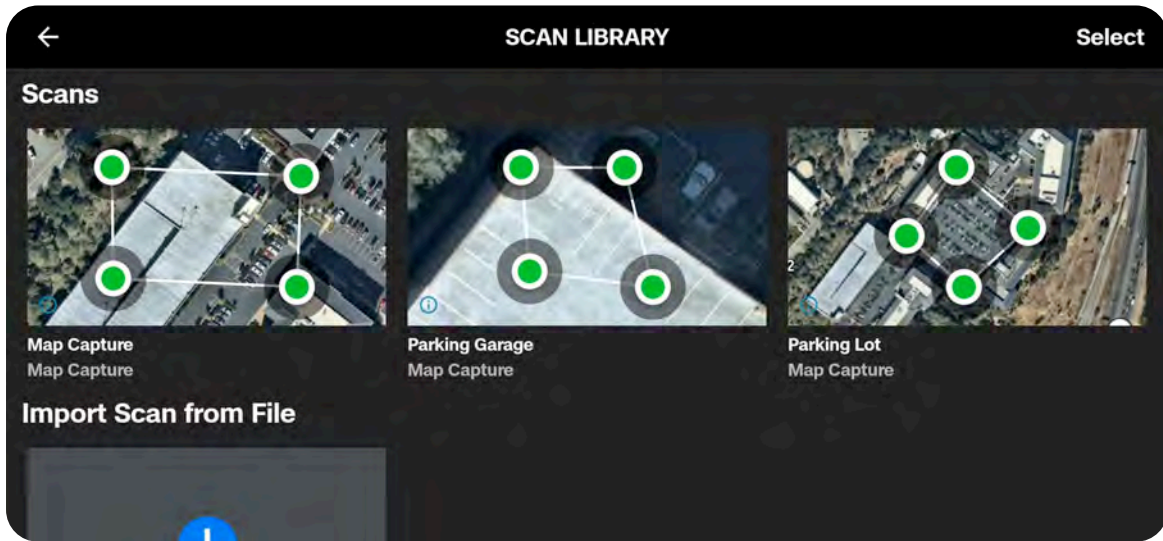

NOTE: Only *.mission* files created from Skydio Map Capture are supported when importing.

Support

Tutorials

Includes step-by-step instructions for actions such as calibration.

Hand Wave Calibration Guide

For use in environments with magnetic interference such as cars, metal bars, power lines, etc. You will need to calibrate before flying at night without NightSense.

About

View the current software version of the X10D Controller, the email associated with your account, and your organization.

Skydio Support Logs

To assist the support team and better troubleshoot any issues or questions you may have, we may require you to upload logs or other data from your drone to help us determine the root cause of any issues.

If you have any objection to this, please let the support team know. We will never review your videos or data without your permission. Do not reformat or factory reset your Skydio drone prior to contacting our support team.

Single Flight Log

Includes all logs from a specified flight. This option will show you the history of all flights, organized by date and time. Select which individual flight you wish to export.

All Logs

Exports all logs saved on the controller from all flight history. This option allows you to sync logs whether you are connected to the drone or not.

Legal

View legal documentation such as the Skydio Safety and Operating Guide.

Flight Controls

Use this menu to customize your joystick controls, input mapping, and altitude limits.

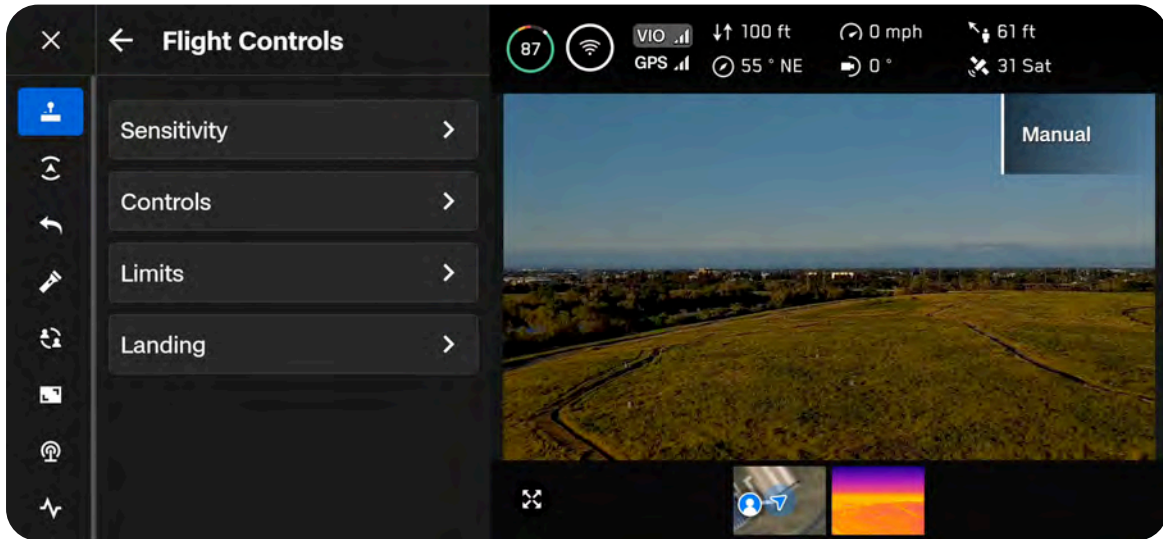

Moving the joysticks allows you to adjust the roll, pitch, yaw, and throttle of the drone.

Roll - Controls left and right movement

Pitch - Controls forward and backward movement

Yaw - Changes rotation around the vertical axis

Throttle - Controls altitude

Sensitivity

Gimbal Pitch

Controls how quickly the camera sensor package moves up and down.

- Default - 18%

Flight

Allows you to customize the maximum allowed speed for roll, pitch, yaw, and throttle.

Default sensitivity:

- Roll - 35%
- Pitch - 35%
- Yaw - 45%
- Throttle - 100%

Rapid Descent

Allows you to increase the speed to the maximum descent rate when pressing and holding Boost (L1 button).

- Descent speed: 27 mph (12 m/s)



NOTE: Increase pitch sensitivity to increase the maximum speed of the drone.

Controls

Battery

Displays Skydio X10D Controller battery level.

Control Mode

Determines how your controller joysticks will maneuver X10D. Select between Mode 1, 2 (default), and 3.

Input Mapping

Allows you to customize buttons and wheels with the following options:

- Toggle Map
- Toggle Camera
- Obstacle Avoidance (Close, Minimal, Disabled)
- Cycle Display Layout
- Cycle Thermal Palettes
- Cycle Full Screen View
- Reset Sensor Package
- Toggle Strobe Lights
- Toggle RGB Lights
- Stop at Structure
- No Function

Customizable buttons include: C1, C2, C3, L2, R2.

You can also invert your wheel directions, assign Exposure Compensation to your Right Wheel (instead of Zoom), or assign No Function to your wheels.



Skydio Flight Deck

Action Wheel

Assign functions to your controller D-pad and quickly preview and select functions in flight.

Once functions are assigned, hold the Back button on the controller to bring up the Action Wheel menu. While holding the Back button, press the D-pad up, left, or right to execute that function

Camera Dragging

Drag your finger on the screen to pitch the sensor package and yaw the drone to look around.

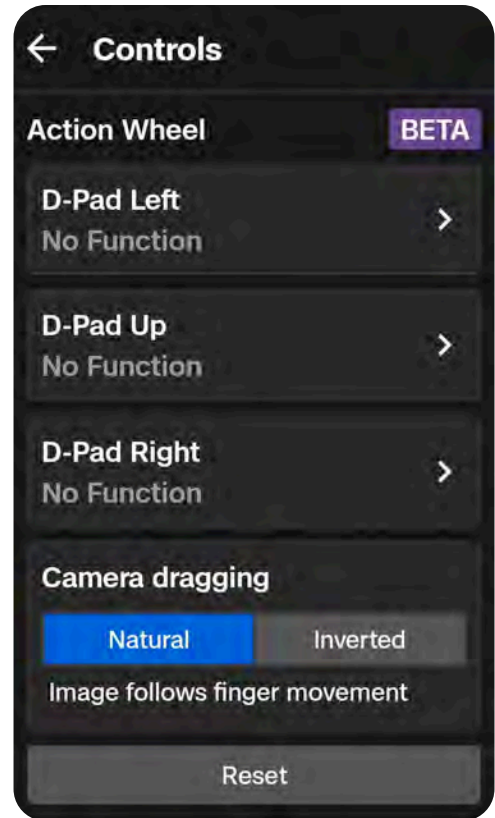

Control Mode

By default, flight controls are set to Mode 2.

In Mode 2, the left joystick controls the elevation and horizontal rotation of the drone, and the right joystick controls the forward, backward, and lateral movements of the drone.

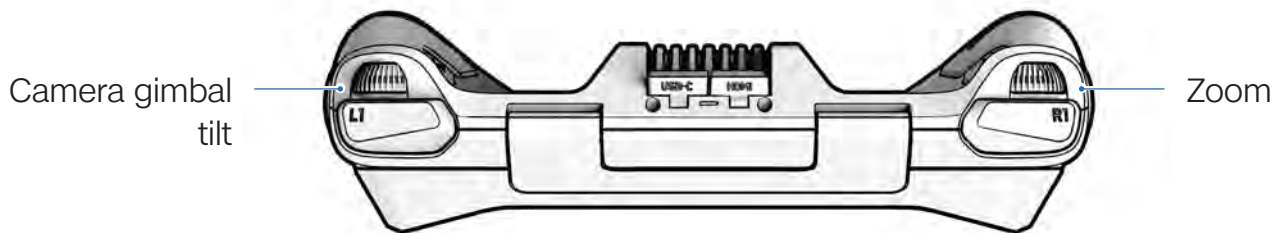
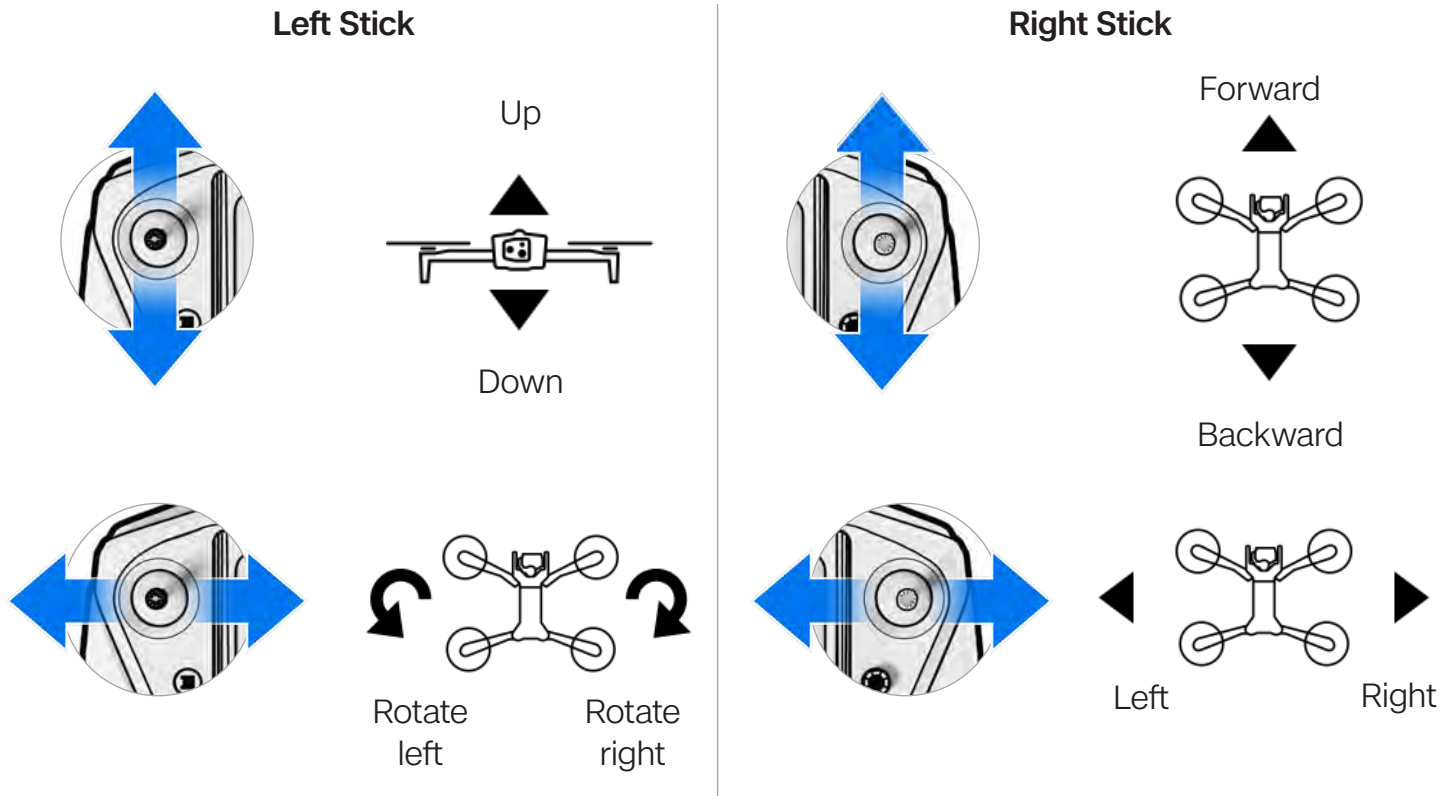

Limits

Height Ceiling

When enabled, allows you to set the maximum allowed drone altitude above the Launch Point.

- Minimum: 30 ft (9 m)
- Maximum: 1500 ft (457 m)

Height Ceiling settings persist across flights and power cycles.

Weak GPS Alt Limit

When enabled, prevents flight above 66 ft (20 m) when GPS is weak.

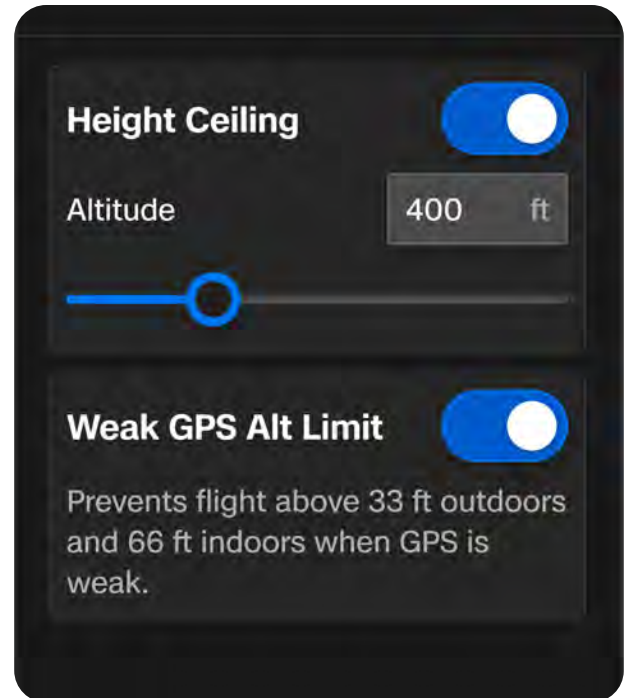

WARNING: *Toggling Weak GPS Alt Limit OFF disables the altitude limit and your drone will fly using only visual navigation. To reduce the risk of an emergency landing, maintain a flight path near surfaces and objects.*

Sensing

Use this menu to adjust autonomous flight behaviors.

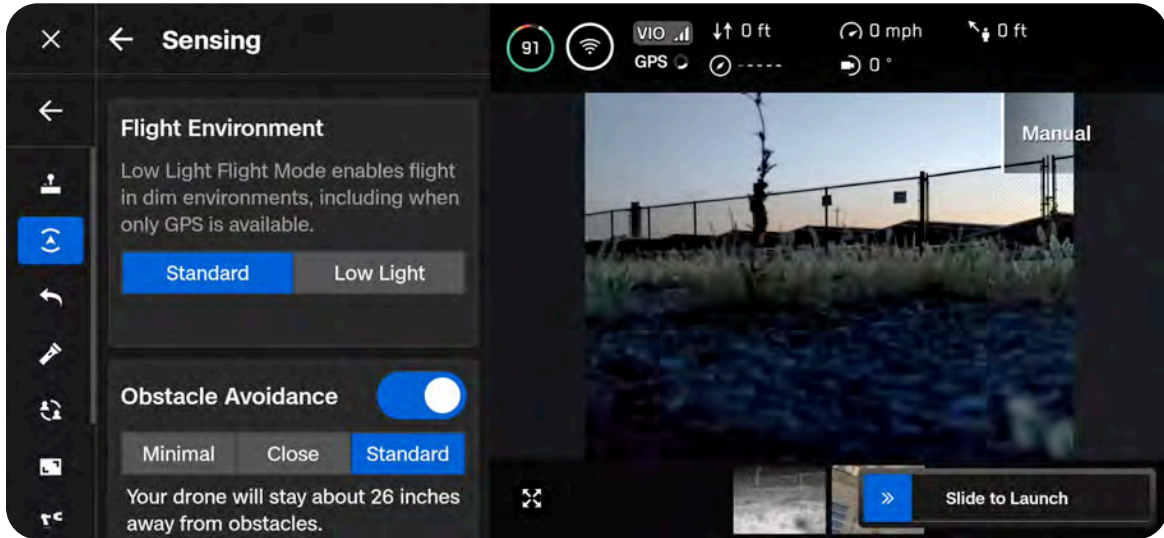

Skydio Flight Deck

Flight Environment

Select either Standard or Low Light to best represent your flight environment

Standard (default) - flight in normal daytime or in brightly lit conditions (i.e. indoors)

Low Light - flight at night or in low-light conditions with poor visibility.

Obstacle Avoidance

When flying near obstacles your drone will follow your selected distance setting. Choose between Standard, Close, and Minimal.

Standard (default) - Drone stays 24 in (60 cm) away from obstacles (15 in, 39 cm in narrow spaces)

- Top ground speed: ~36 mph (16 m/s)

Close - Drone stays 6 in (15 cm) away from obstacles (5 in, 13 cm in narrow spaces)

- Top ground speed: ~18 mph (8 m/s)

Minimal - Slight course corrections to avoid obstacles, but primarily relies on the pilot to avoid collisions.

- Top ground speed: ~18 mph (8 m/s)

Disabled (toggle off) - Skydio X10D will not avoid obstacles and there is a high risk of collision

- Top ground speed: ~45 mph (20 m/s)

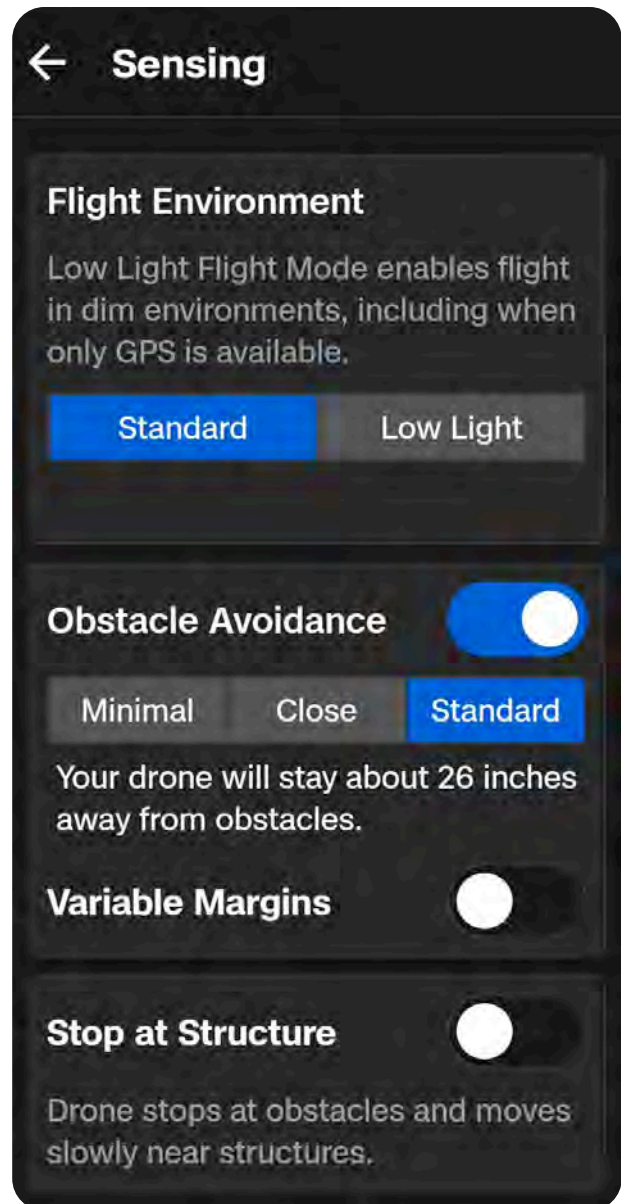

Skydio Flight Deck

Variable Margins

Skydio X10D uses AI and visual navigation to dynamically, and temporarily, reduce obstacle avoidance margins when moving through narrow spaces. Margins will also dynamically expand if the drone detects environmental dangers, such as wind.

Enabled by default. Disable to turn off the dynamic margin behavior.

Stop at Structure

Perform finer, more controlled inspections on structures such as bridges or building facades.

When enabled, your drone will not deviate from its course when it is within 8 ft (2.5 m) of a structure.

The drone will reduce speed and maintain position, allowing for more precise maneuvering in the immediate vicinity of the structure.

- Adjust the maximum speed using the Speed Near Obstacles slider
- Maximum controller speed settings apply when no structure is present
- Stop at Structure is active during manual flight, including when paused during a 3D Scan



CAUTION: *Flying with Close, Minimal or Disabled settings greatly increases the risk of collision. Minimal or Disabled settings are used to navigate tight spaces and should only be used if you are an experienced pilot. Skydio recommends turning down controller throttle, roll, and pitch sensitivity to the lowest setting and proceeding at a maximum speed of 2 mph (1 m/s).*

Return

Configure your standard return behaviors as well as how Skydio X10D will return if connection is lost.

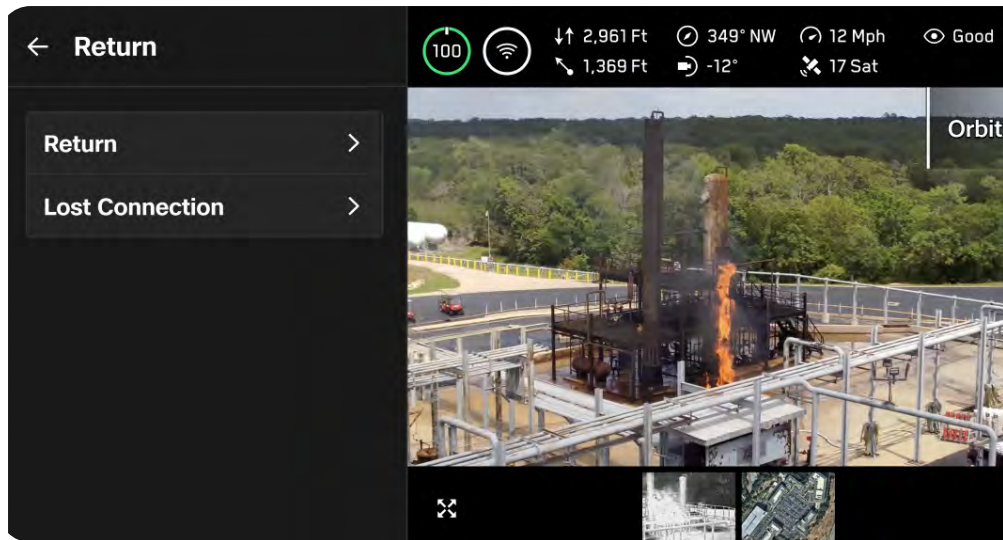

WARNING: Before flying, ensure you have set your Lost Connection Return Behaviors. This is a critical step that ensures your drone returns safely and lands in an accessible location.

Return

Height Behavior

Customize the altitude behavior of Skydio X10D when returning.

Use Return Height to set the altitude at which the drone will ascend to before returning.

Absolute means your drone will ascend to the specified Return Height above the Launch Point before returning

- For example, if the Return Height is 32 ft and the drone is at 20 ft at the time the return is commanded, Skydio will ascend 12 ft before returning

Relative means your drone will ascend to the specified Return Height above the current position before returning

- For example, if the Return Height is 32 ft and the drone is at 20 ft at the time the return is commanded, Skydio will ascend 32 ft and then return at a height of 52 ft

Drone Will Face

Set Skydio X10D to either look toward or away from the return destination while flying.

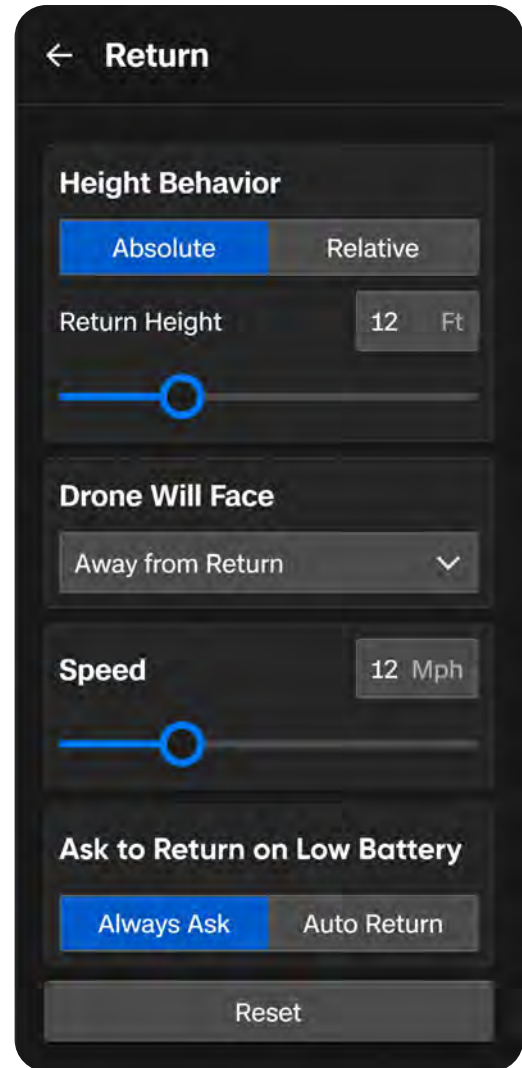

Skydio Flight Deck

Speed

Set the speed at which Skydio X10D returns

- GPS return: 1 - 45 mph (0.5 - 20 m/s)

Ask to Return on Low Battery

When the battery is only sufficient to return and land, choose between a prompt or an automatic return.

Always Ask (default) means you will be asked to select the return location each time the battery level is low.

Auto Return means the drone will automatically return to either the Launch Point or the Home Point (if set) when the battery is low.

Lost Connection

If connection is lost, Skydio X10D will default to the **Lost Connection** settings. Select between **Return** and **Hover** upon lost connection.

Return

Wait Before Return - set the amount of time you want Skydio X10D to wait before it initiates a return flight, allowing time to reconnect

Land After Return - when enabled, your drone will return, hover for a specified amount of time, then land.

Wait Before Land - the amount of time between 0 to 300 seconds (default is 240 seconds) that you want your drone to wait above the landing location before landing. This setting is only enabled when Land After Return is toggled on.

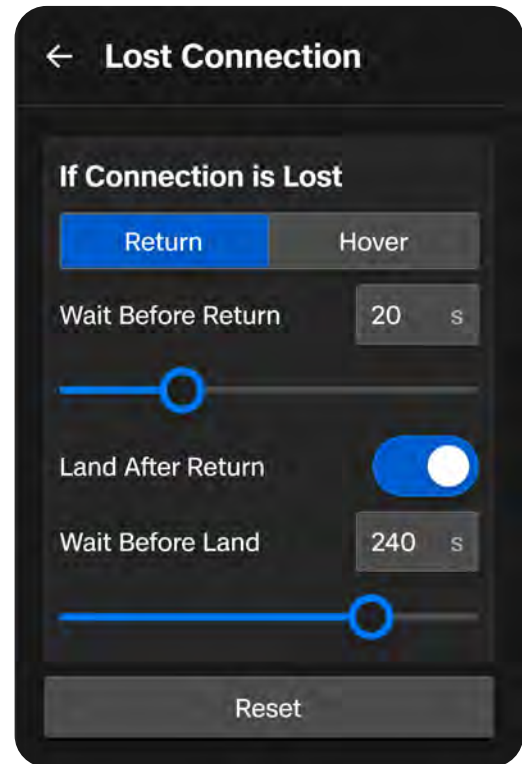

Hover

Land After Hover - when enabled, Skydio X10D will hover for a specified amount of time, then use visual navigation to find a safe area to land.

Wait Before Land - the amount of time between 0 to 300 seconds (default is 240 seconds) that you want your drone to wait before landing. This setting is only enabled when Land After Hover is toggled on.

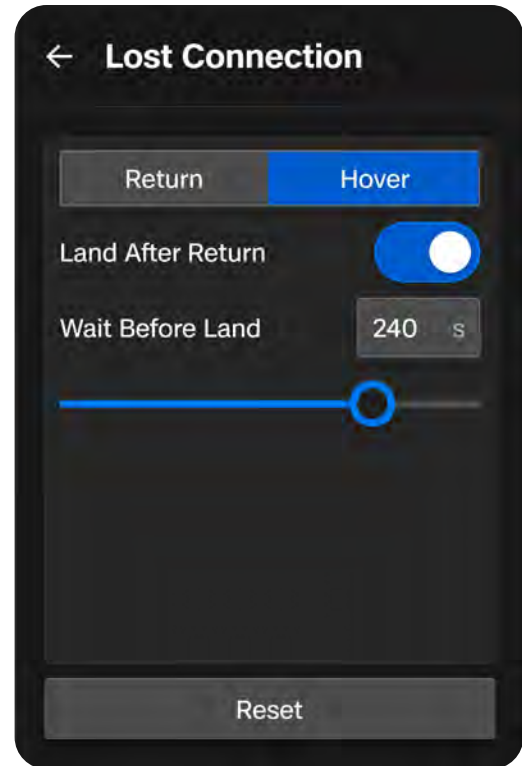

Skydio X10D will continue hovering as it tries to regain connection. If it fails to reconnect and reaches low battery:

- If you have an automatic return set, your drone will return to either the Launch Point or Home Point (if set)
- If you do not have an automatic return set, your drone will use visual navigation to find a safe area to land
- If VIO is degraded (flying in Low Light without NightSense), your drone will be unable to use visual navigation and will descend vertically and land

Lighting

Customize the in-flight behavior of the RGB/strobe lights that are located at the end of the arms.

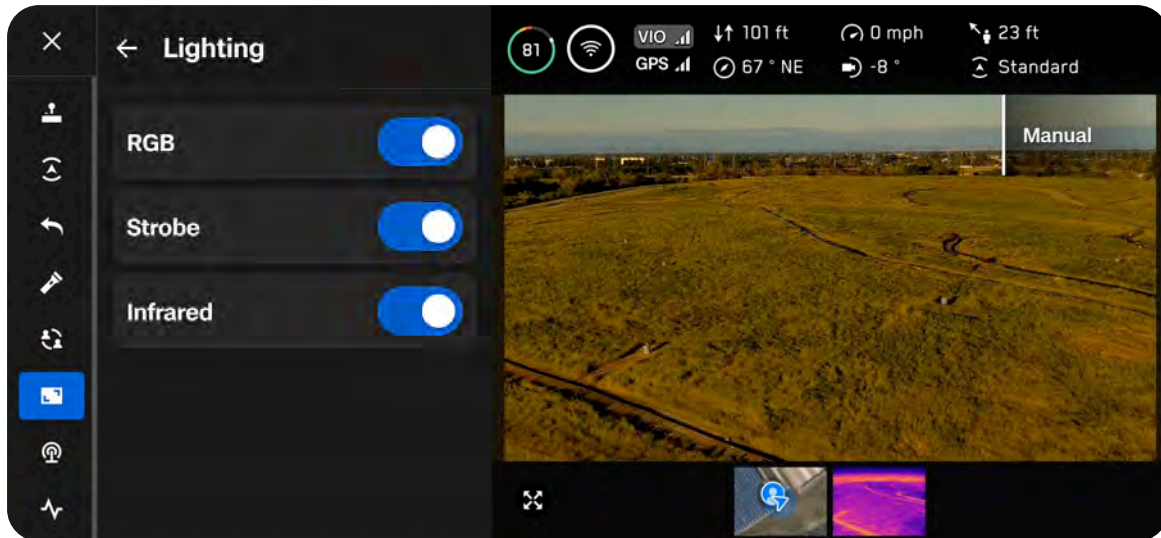

RGB

When enabled, the lights on the end of the arms will appear red and green while flying. When the drone is powered on and grounded, the lights will appear blue.

Strobe

Enable to visually track the drone in low-light conditions. Skydio X10D strobe lights meet the FAA requirement of being visible at a distance of 3 statute miles (4.8 km).

Infrared

Cannot be seen by the naked eye. These broadcast an IR light that can only be detected with an infrared lens. Assists with navigation in low-light.

Connection

The Connection menu allows you to stream using ATAK or RTSP.

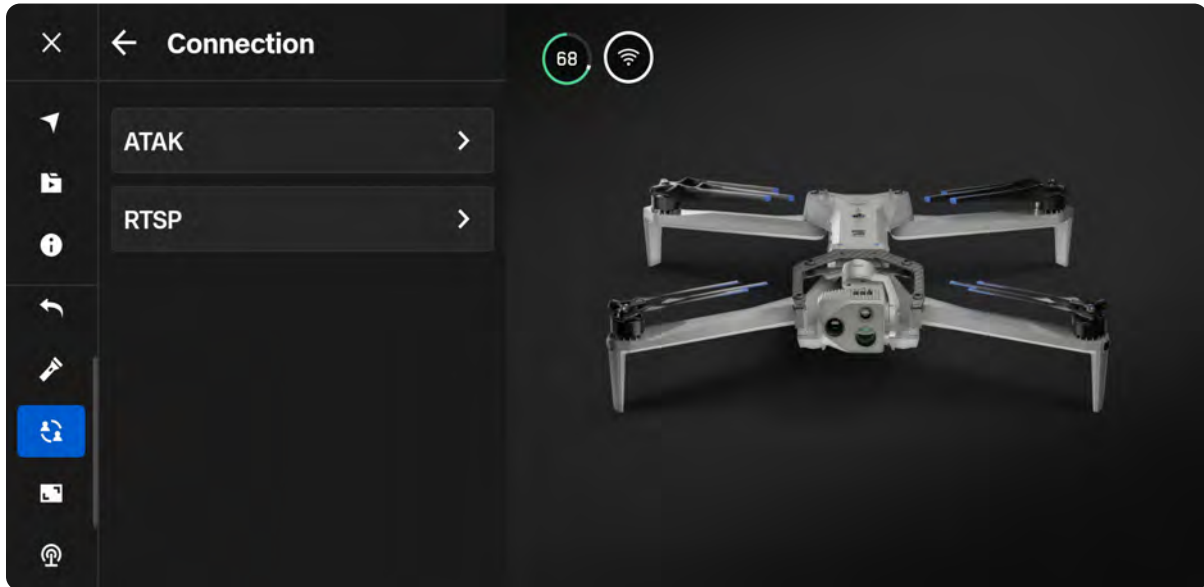

ATAK

The integration of the Skydio X10D Controller and the Android Team Awareness Kit (ATAK) app allows you to seamlessly monitor your Skydio fleet. ATAK provides geospatial information about your drones and controllers for increased situational awareness in the field.

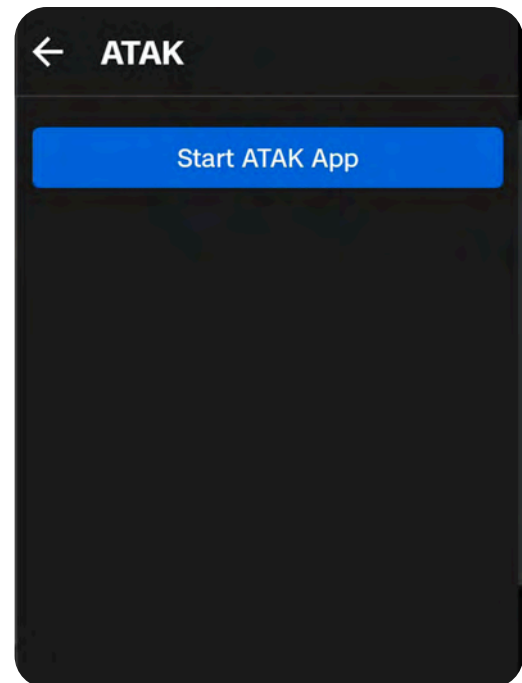

INFO: For more information about setting up ATAK, visit [How to set up ATAK with the Skydio X10D Controller](#).

Radio

Use this menu to configure your radio settings. Toggle Dynamic Channel Switching on or off and manually select your frequency.

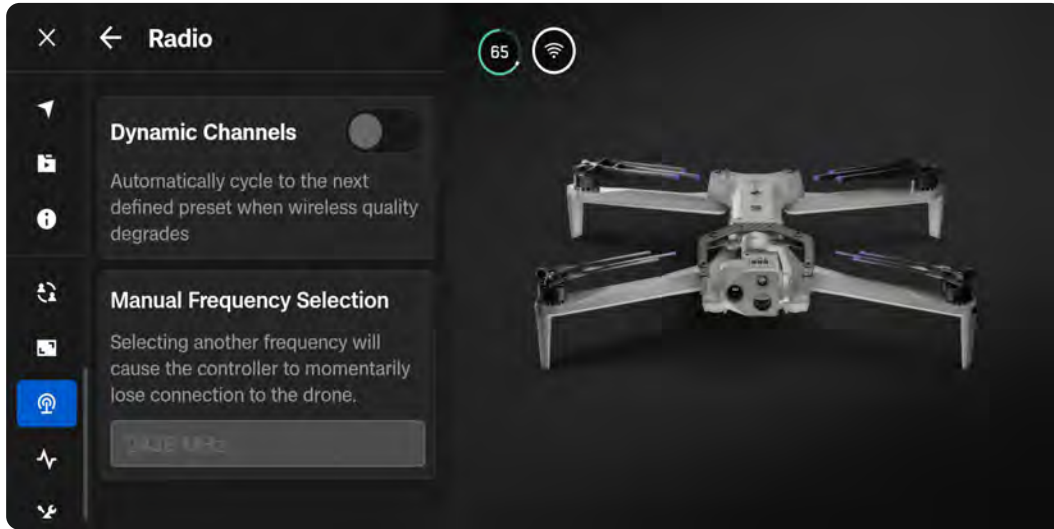

Dynamic Channel Switching

Cycle through six preset frequencies to automatically find the cleanest channel, ensuring stable and reliable flight.

Step 1 - Select Global Setting, the Information menu, and the Radio tab

- Select the power, channel, and band for each preset
- Select Finish

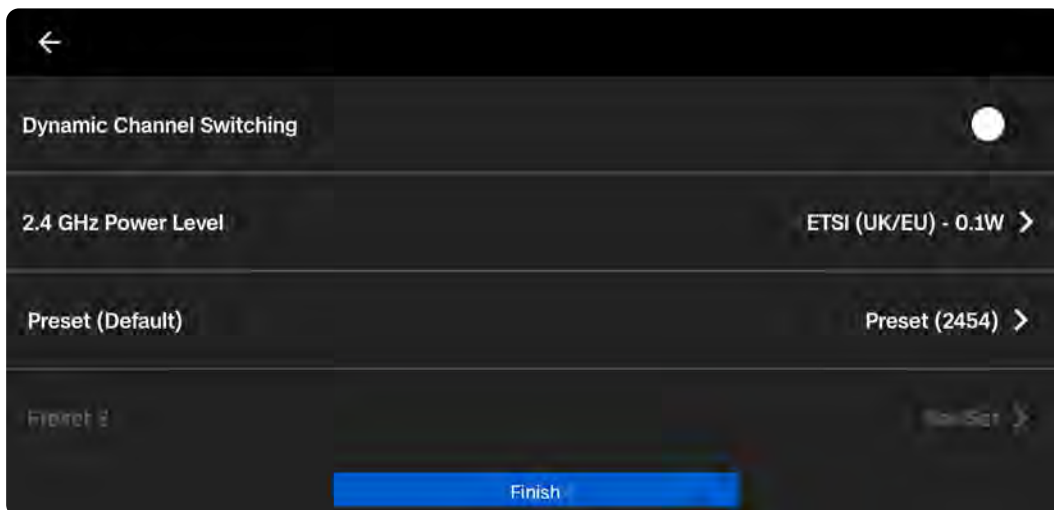

Display

Customize your Flight Screen display, including telemetry metrics, unit type, and depth style.

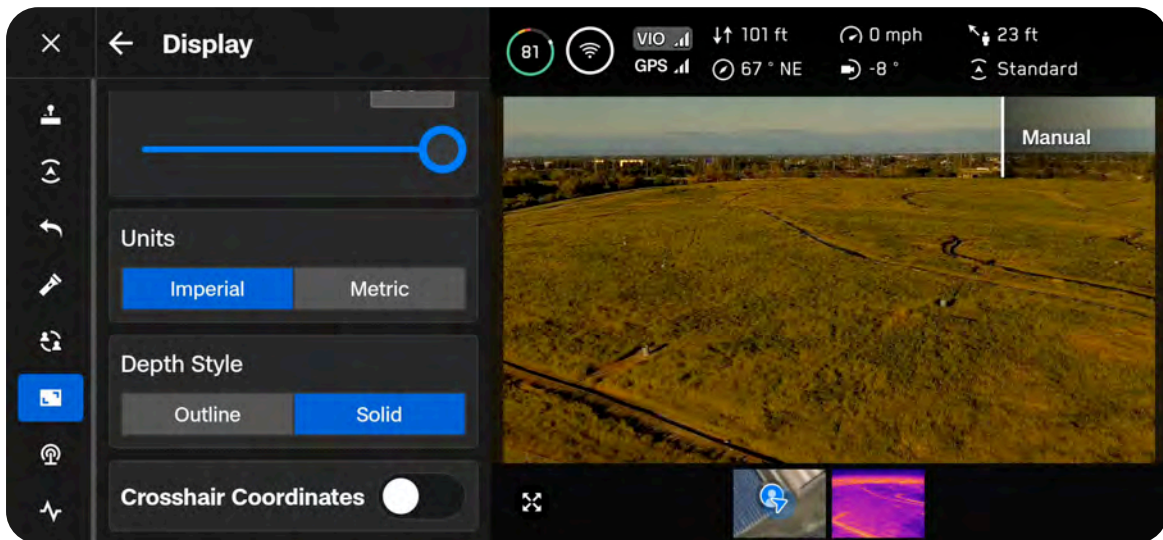
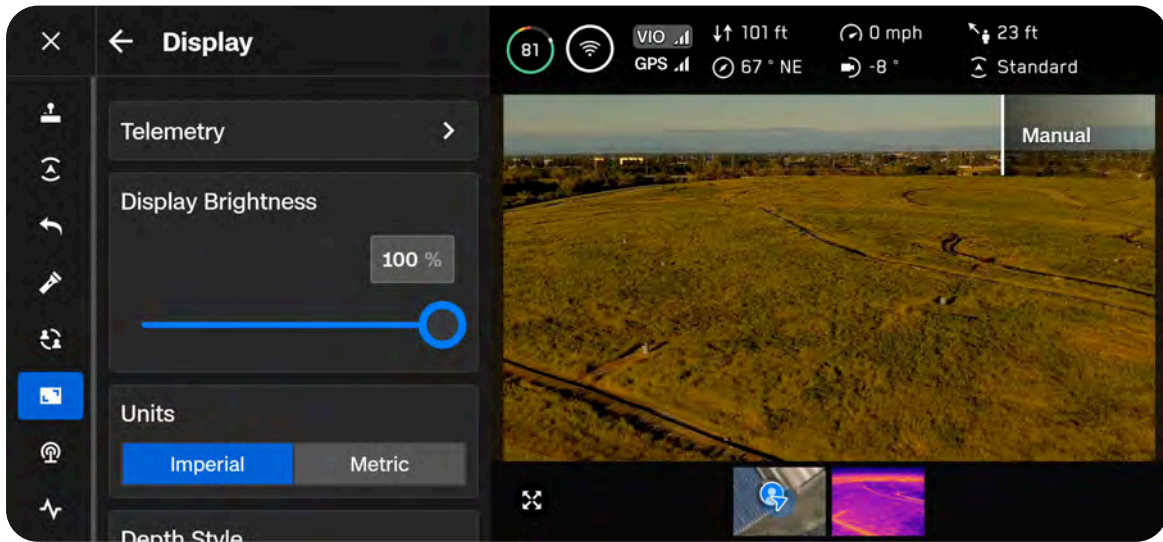

Skydio Flight Deck

Telemetry

Customize the telemetry metrics you want to display while flying. Select the blue check mark to enable or disable the corresponding telemetry information. Select up to 6 items to display on your telemetry bar:

- Altitude
- Distance from Launch
- Heading
- Ground Speed
- Gimbal Pitch
- Distance from Controller
- GPS Satellite Count
- Obstacle Avoidance
- Radio Frequency

Display Brightness

Adjust the brightness of your X10D Controller screen.

Units

Choose between Imperial or Metric units.

Depth Style

Only applies if you have enabled Depth View within the AR Quick Actions (located on the left side of the Flight Screen).

Select **Solid** or **Outline** when displaying visual information about what obstacles the drone sees.

- Solid displays boxes filled with color
- Outline displays framed or unfilled boxes

The AR Quick Actions button on the Flight Screen cycles between the distances from objects at which the visual information will start showing on screen.

- Off
- 6 ft (2 m)
- 13 ft (4 m)



Display Layouts

While flying, you have the option to use a Single, Split or Grid layout to set the number of streams that appear while flying. Available feeds include:

- Color
- Thermal
- Map

Single Layout

Displays one stream at a time.

In this layout, you will see a Picture-in-Picture (PiP) in the bottom left of the screen.

- Minimize using the two arrows in the top right
- Use the buttons on the bottom to select whether the Color, Thermal or Map feed displays in the PiP

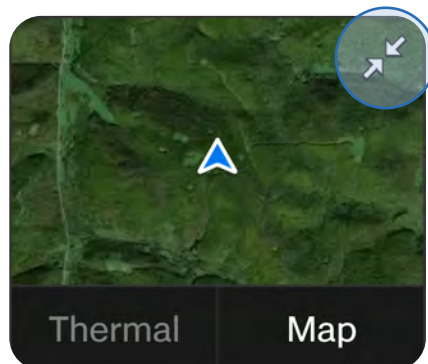
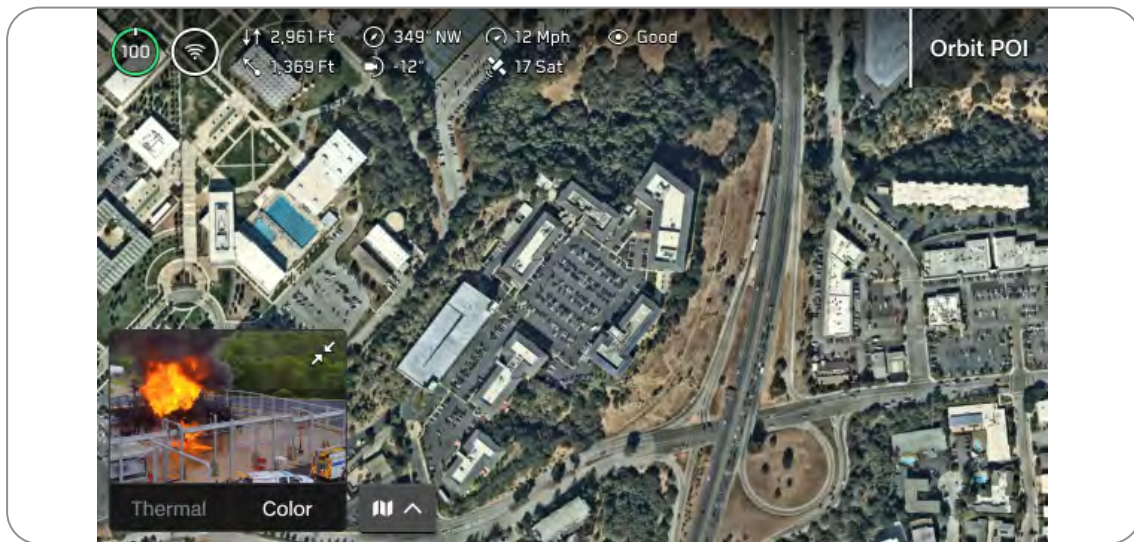

Skydio Flight Deck

Split Layout

Choose two streams to display. Drag the middle handlebar to resize streams.

The primary feed displays on the right.

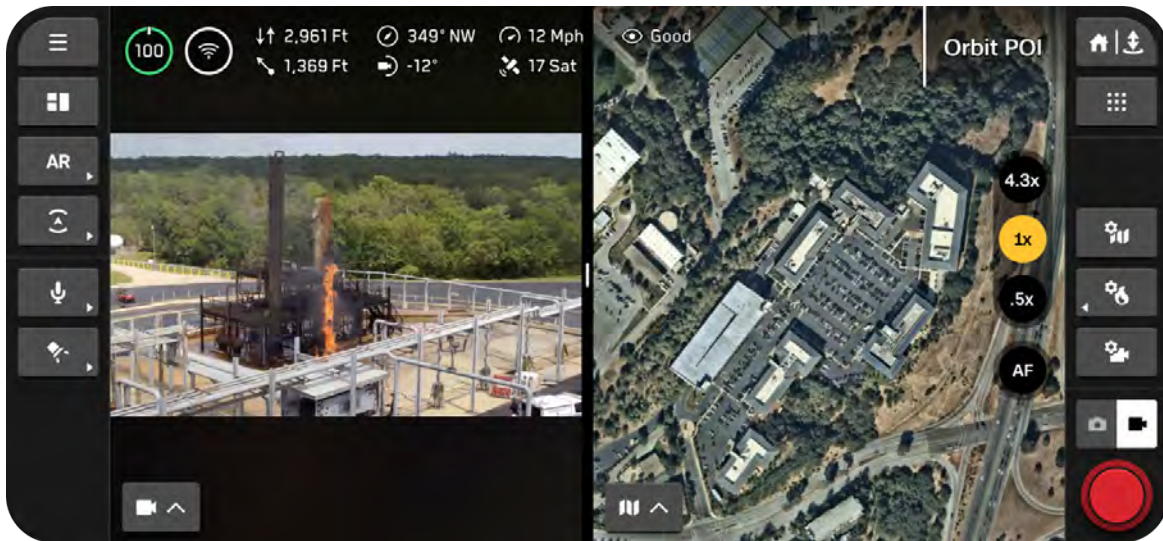

Grid Layout

Choose three streams to display. Press and drag the middle handlebar to resize streams.

The primary feed displays on the right.

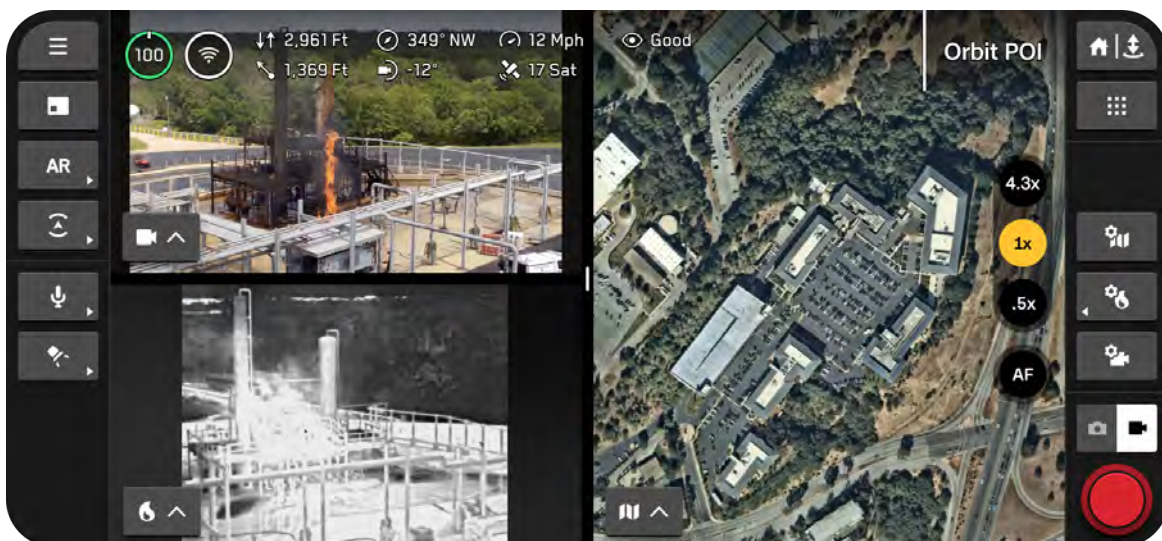

Customizing Display Layout

Step 1 - Select the Display Layout icon in the left sidebar

Use this button to cycle through the various layout options. The icon reflects the next layout in the queue rather than the layout you are currently using.

-  Single Layout
-  Split Layout
-  Grid Layout

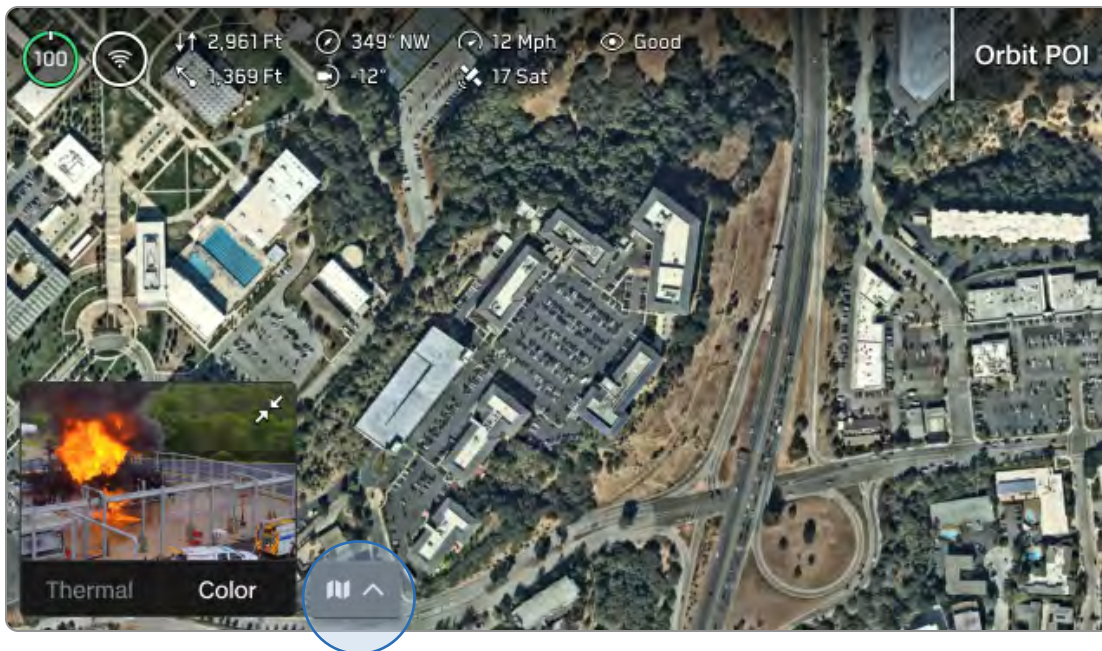

Skydio Flight Deck

Step 2 - Use the View Selector to select which feeds display

A menu will appear with the stream options. Drag the middle handlebar to resize streams.

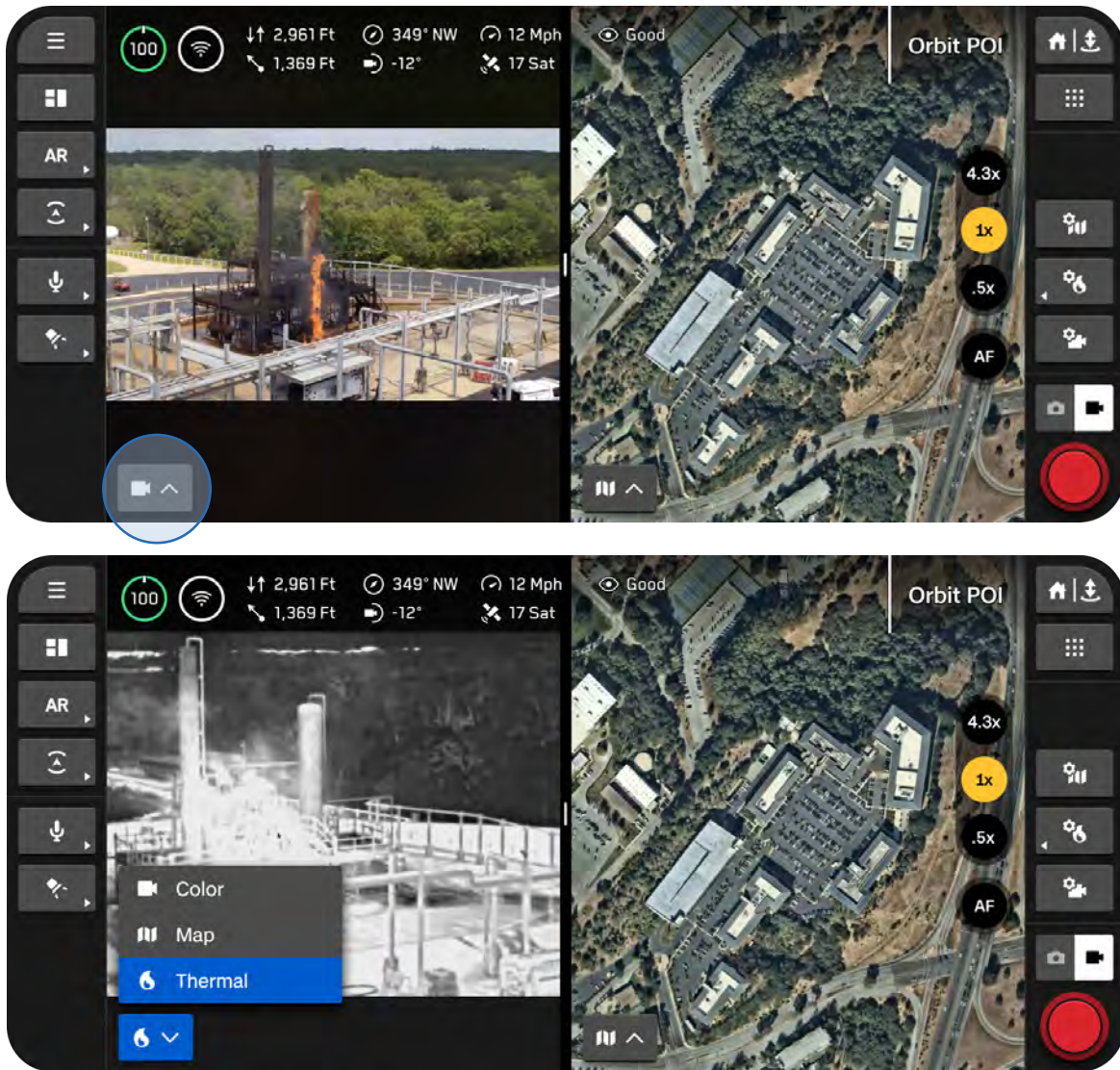

System Status

Provides a comprehensive overview of the system at a glance.

Displays:

- Drone connection quality
- GPS signal quality and position accuracy
- ATAK status

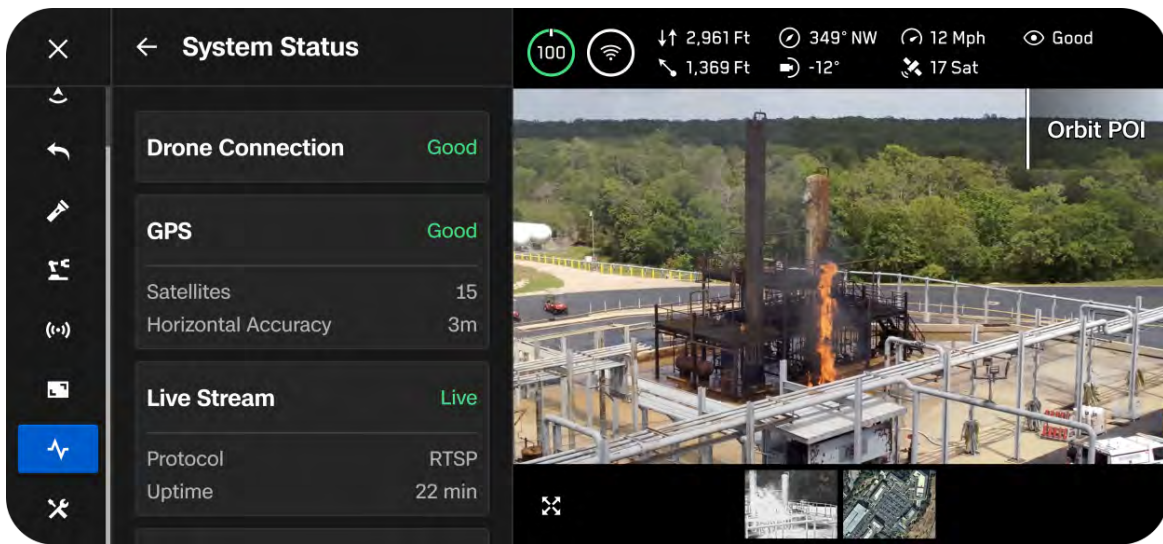

Quick Actions

The left sidebar of your Flight Screen contains a variety of Quick Action menus. With Quick Actions, you have the ability to quickly **toggle** a setting or **cycle** through setting options.

Toggle

Full green bar indicates a setting is ON.



Cycle

A menu will pop out and label the current setting. The green bars indicate the number of available settings.

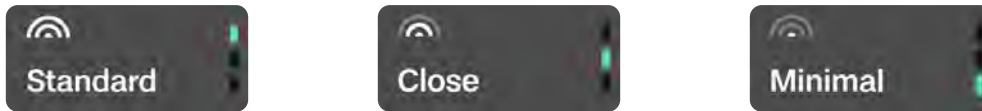

Augmented Reality (AR) Quick Actions

Enable to visually display where Skydio X10D detects obstacles in the environment. Appears as either solid or outlined augmented reality (AR) boxes, depending on your selection within the **Display** menu.

Use the **AR Quick Action** button to cycle between the distances from which obstacles are rendered on the screen. Objects that are closer appear red.

- Off
- 0 - 6 ft (0 - 2 m)
- 0 - 13 ft (0 - 4 m)

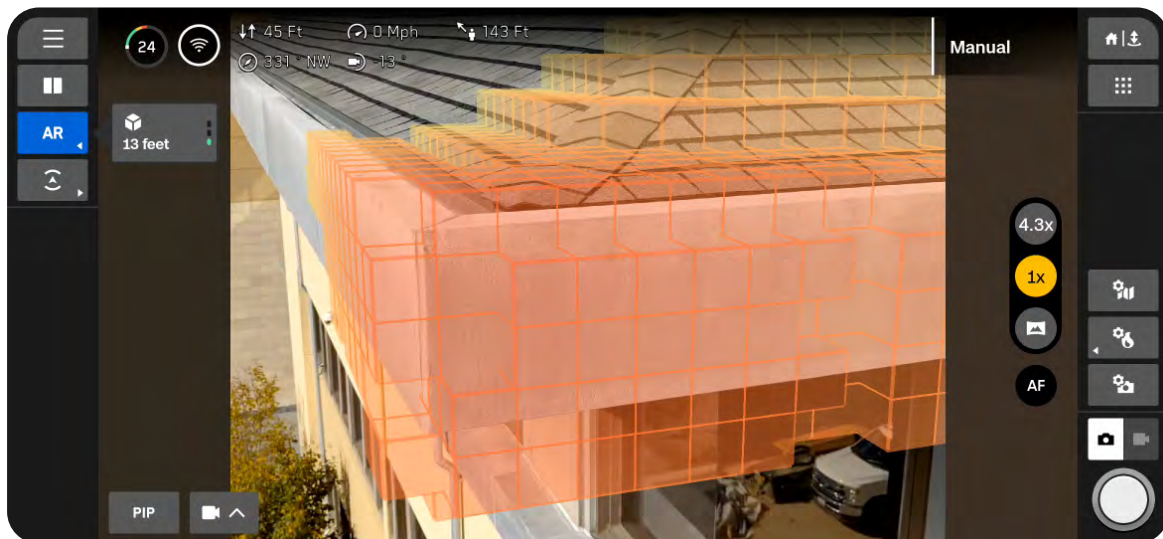
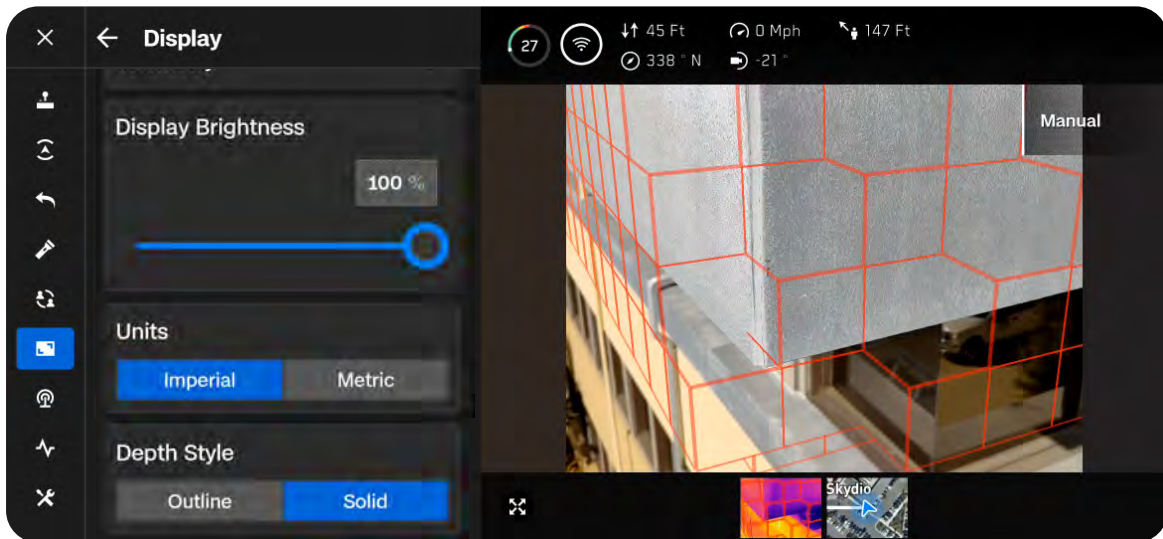

Obstacle Avoidance Quick Actions

Quickly cycle through the three obstacle avoidance settings, available in the **Sensing** menu.

A yellow border appears when in Close or Minimal obstacle avoidance mode.

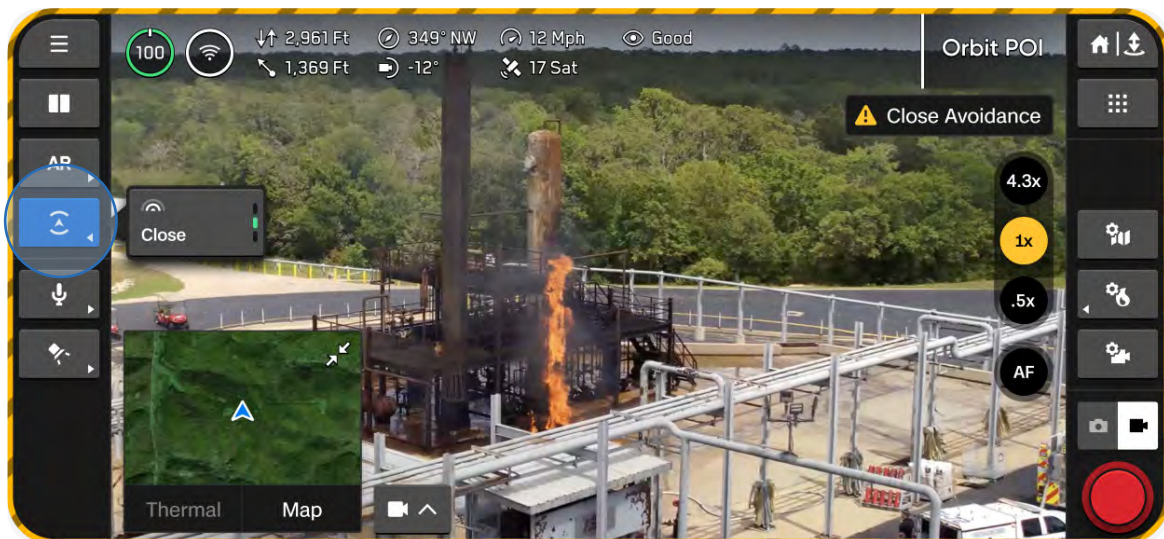

Inflight Map

View your current location, search, set a Home Point, and configure map settings.

- The location of Skydio X10D, the controller, Launch Point, and Home Point (if set) are indicated on the map
- Press and hold on a location to set a **Home Point**



Skydio X10D



Controller



Launch Point



Home Point

Adjust your map settings during flight using the **Map Settings** icon.

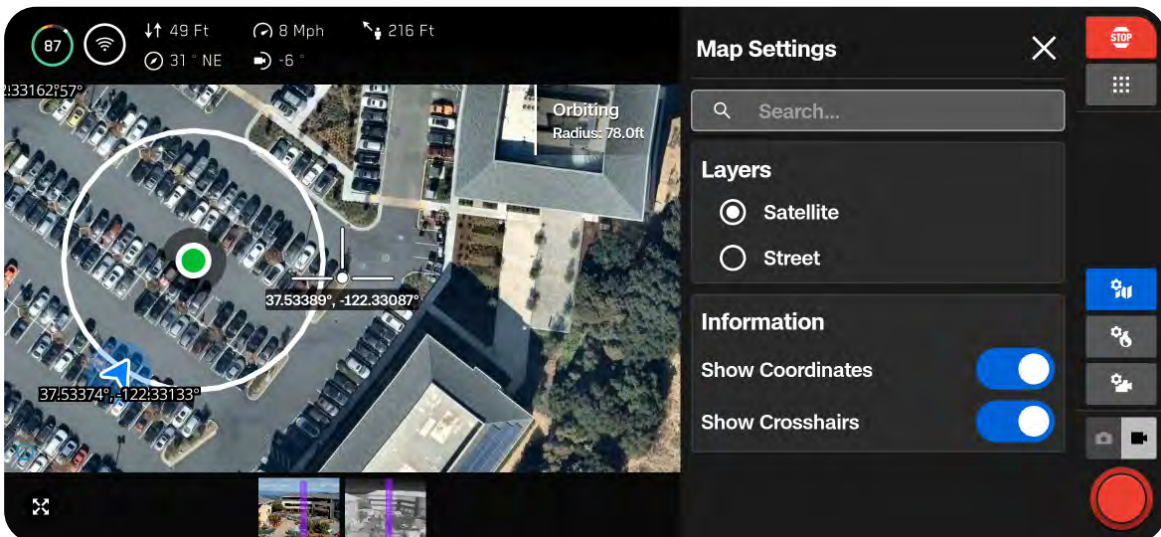
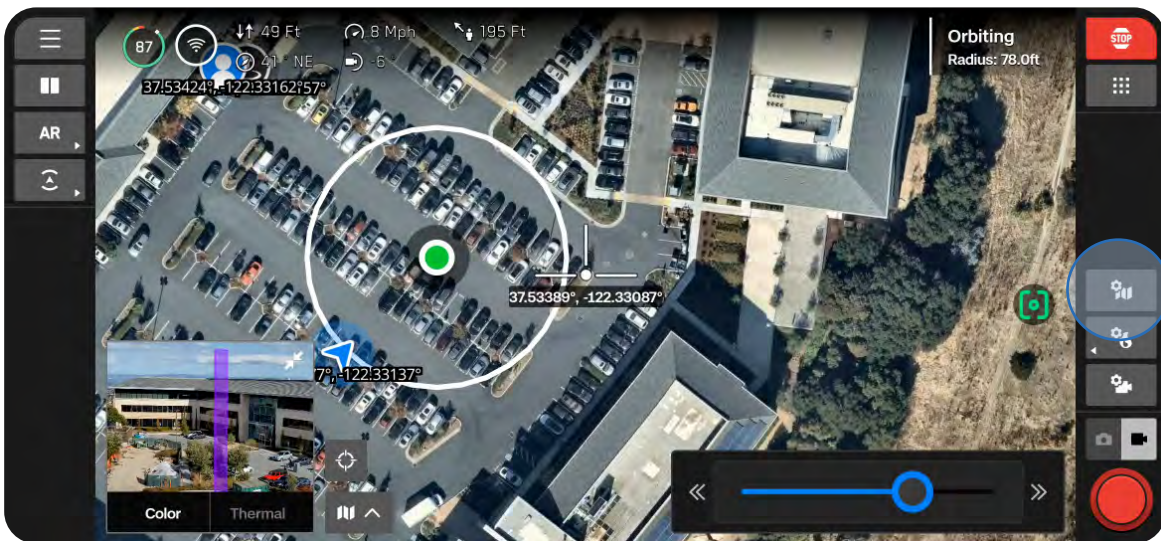



Camera Settings

Learn how to adjust camera and video settings such as zoom, exposure, ISO, and resolution.

This section covers

Overview

Capture Settings (Photo and Video)

Focus and Exposure

Zoom Settings (Photo and Video)

Shutter Indicators

Photo Settings

Video Settings

VT300-L Flashlight

Overview

When your drone captures a photo or video, it will save one image file with the color camera. Two files will save if you have JPG and DNG enabled. If you would like Skydio X10D to also capture an image file with the thermal camera, enable **Thermal Capture** within the **Thermal Settings**.

Use **Camera Mode** on the right sidebar to switch between photo or video. Skydio X10D can capture photos or videos but not both at the same time. Your color and thermal cameras will always be in the same Camera Mode.

Access your photos and videos using the **Media** menu located in **Global Settings**.

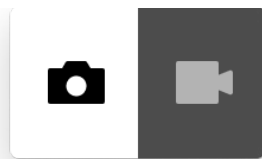
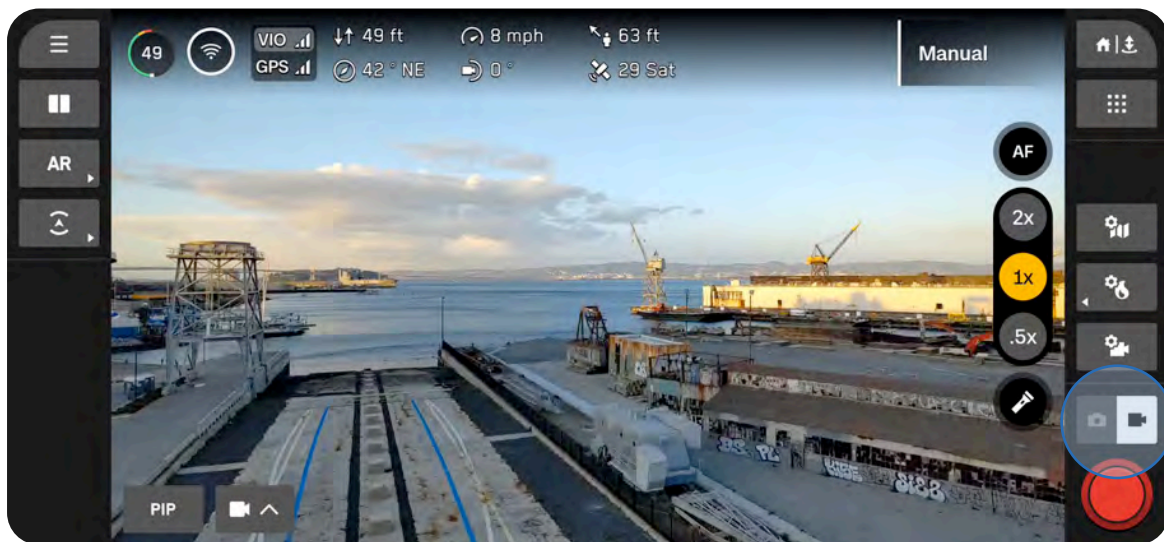

Photo enabled



Video enabled



NOTE: Photo and Video mode settings are independent of each other and persist through mode changes, but not power cycles.

Capture Settings (Photo and Video)

Brightness Exposure Value (EV)

Refers to the amount of light the camera allows in.

Negative numbers result in darker images (less exposure) while positive numbers result in brighter images (more exposure).

- Brightness is set to Auto by default

White Balance

Balances the color temperature in your photo. If the whites in your picture are too orange, for example, adding the opposite color (blue) will balance them out.

Lower values result in a cooler (blues) image while higher values result in a warmer (yellows) image.

- Auto (default) means Skydio X10D will automatically adjust the White Balance for its environment

ISO

Brightens or darkens your photo. When in low-light conditions, raising the ISO value will brighten the image, however you may see some graininess.

- Auto means Skydio X10D will automatically adjust the ISO for its environment

Shutter

Refers to the length of time a photo is exposed.

Slower shutter speed means greater exposure, while faster shutter speed means less exposure.

- Auto means Skydio X10D will automatically adjust the Shutter speed based on the available light

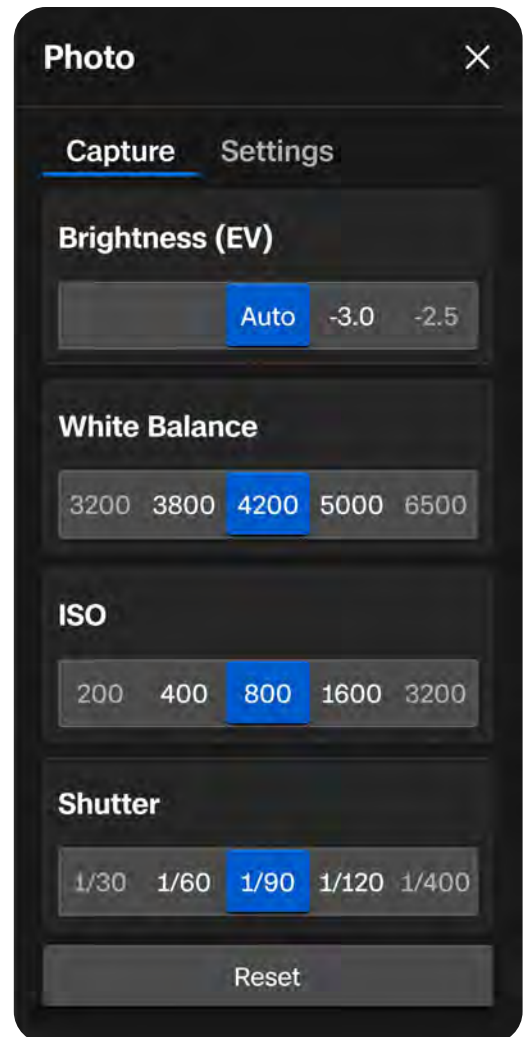

Focus and Exposure

To view the various focus options, select the Focus Control button on the right side of the Flight Screen.

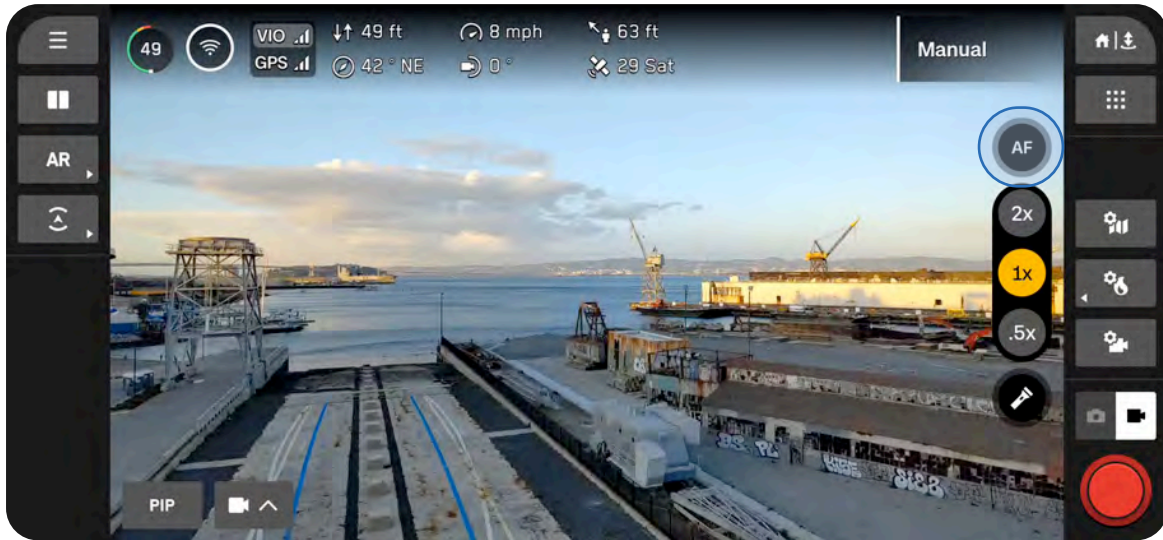

AutoFocus (AF)

By default, your camera will be set to automatically adjust focus and exposure. In this focus mode, focus will generally prioritize objects in the center of the screen.



Manual Focus (MF)

After selecting the Manual Focus icon, two more button options will appear.

- Use the image of the mountain to focus on objects further away
- Use the image of the flower to focus on objects that are closer



Tap to Focus

Touch anywhere on the screen to focus on an area of interest, or select the icon to center. The Focus Indicator will turn green once the image is sharp and clear.



Zoom Settings (Photo and Video)

To zoom in digitally, place your finger on the right controller wheel and push it to the left. Customize this using Input Mapping (Flight Controls > Controls).

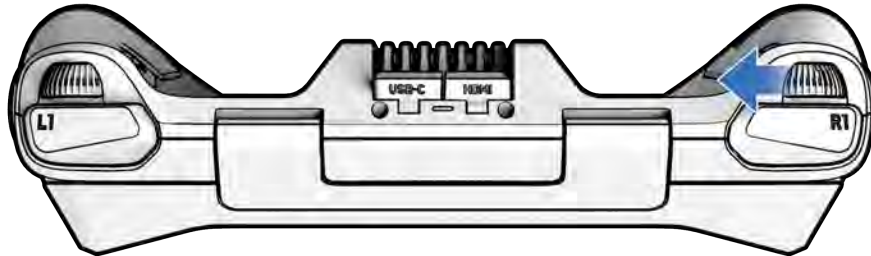

Quickly snap to a zoom level using the Zoom buttons on the right side of the screen.

VT300-Z Sensor

- 4.3x - transitions between narrow and telephoto lens, 128x max system zoom
- 1x - default zoom level of narrow lens
- .5x - Surround Vision

VT300-L Sensor

- 2x - transitions between wide and narrow lens, 64x max system zoom
- 1x - default zoom level of wide lens
- .5x - Surround Vision



NOTE: Images and videos taken while zoomed in will be saved at that zoom level.

Camera Settings

Surround Vision

Surround Vision uses Skydio X10D navigation cameras to generate an ultra-wide view of your environment for situational awareness.



NOTE: Photos and videos captured when in Surround Vision will be saved at 1x zoom.

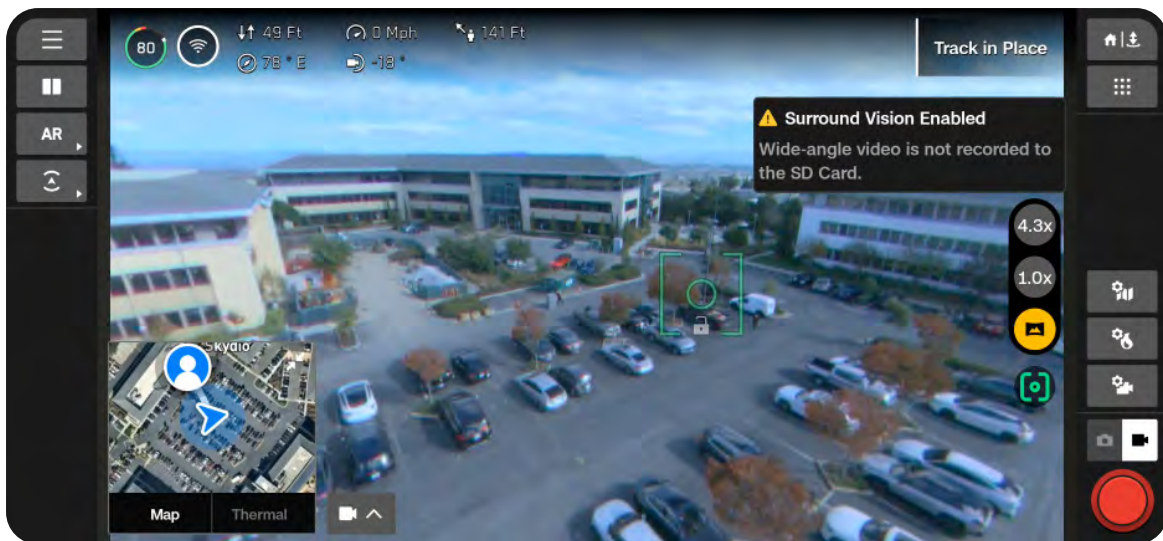

Thermal Zoom

The thermal camera will zoom up to 16x, but you may continue to zoom using the color camera. If any Tools are enabled, such as Region of Interest, they will dynamically adjust to fit the screen as you zoom.

Shutter Indicators

The Shutter is located in the bottom right of the Flight Screen and indicates the current state of Photo or Video mode.

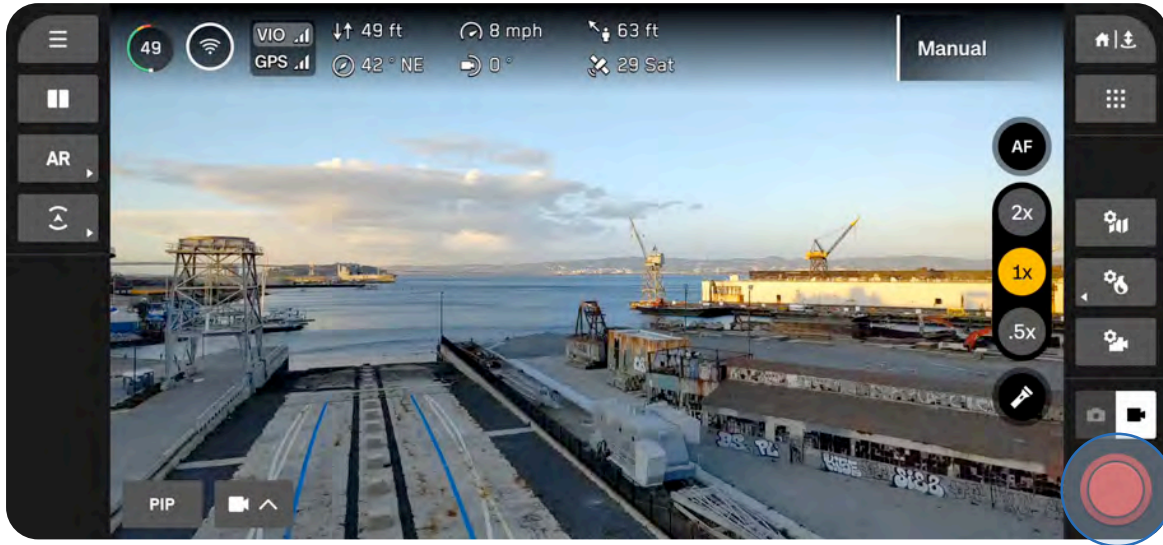

Photo

Ready for Capture



Pressed



Disabled



Interval



Video

Manual Record



Manual Record (Pressed)



Recording



Recording (Pressed)

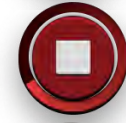

Auto Recording



Auto Recording (Paused)



Photo Settings

File Type

Choose whether you want Skydio to capture JPG images only, or both JPG and DNG files.

- **JPG** - Digital image format containing compressed image data.
- **DNG** - RAW image format file, meaning it is not compressed and retains all original photo data. A DNG file is larger than a JPG file since it stores image data.

Resolution

Refers to the amount of detail in your video. Measured in megapixels.

- **Full** - Images are captured at the highest quality, providing more detail and clarity.
- **1/4** - Images are captured at one-fourth of the full resolution, resulting in smaller file sizes. Best for conserving storage space or transmitting images faster.

Camera Mode

- **Standard** - Designed for typical, everyday lighting conditions. Provides a balanced, standard level of exposure, image processing, and contrast.
- **Low Light** - Designed for environments with dim lighting, such as indoors or evening. Settings are adjusted to capture more light, reduce noise, and improve visibility. Only available with 1/4 Resolution.
- **HDR** - Designed to capture environments with a wide range of brightness levels. Only available with 1/4 Resolution.

Interval

When enabled, Skydio X10D will continuously capture photos at the specified time interval until the setting is disabled or the flight ends.

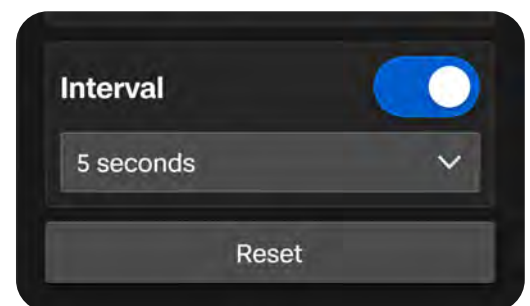
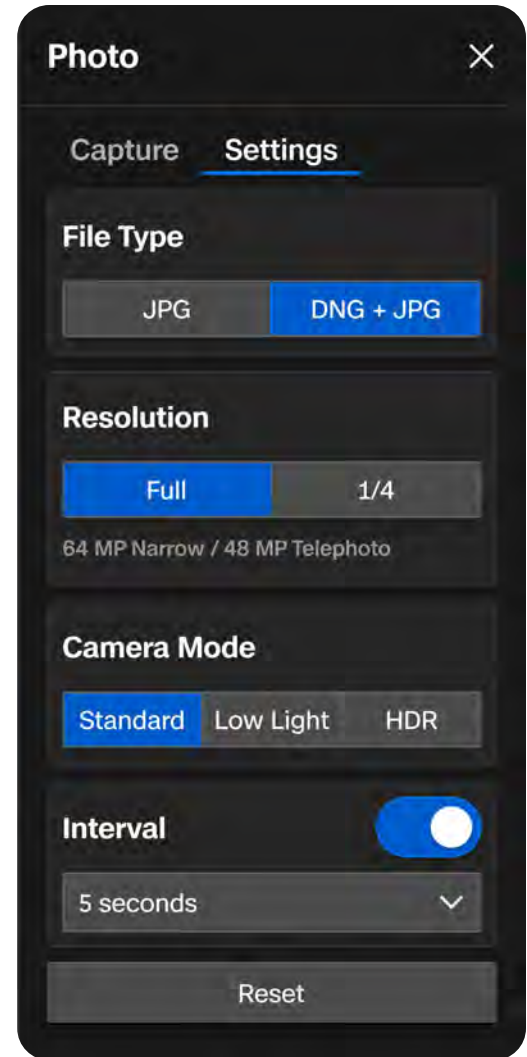

Video Settings

Auto Start Recording

When enabled, Skydio X10D will record video automatically.

When disabled, tap the on-screen Shutter button or on the controller (R1 button) to start/stop video recording.

File Type

Select between H.264 and H.265 compression formats, depending on your preferences for video quality, file size, and playback compatibility.

- **H.264** - Provides manageable file sizes without sacrificing video quality. Recommended for standard video recording, and compatible with most devices and video editing software.
- **H.265** - Ideal for high-quality video capture and maintains efficient compression.

Resolution

Select between 4K and Full HD, which refers to the amount of detail in your video. Measured in pixels.

- More pixels result in a high-resolution video
- Fewer pixels result in a lower resolution video

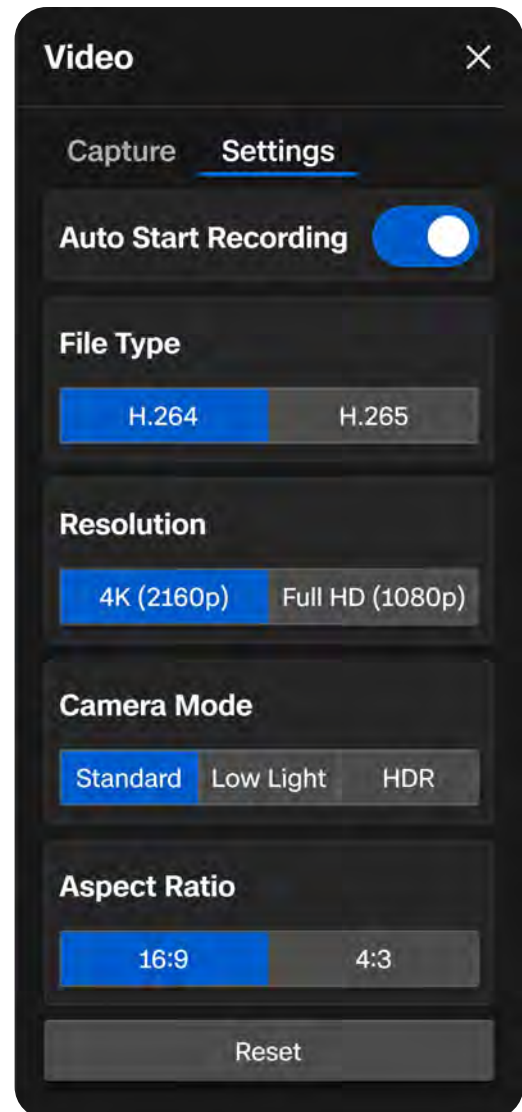

Camera Settings

Camera Mode

- **Standard** - Designed for typical, everyday lighting conditions. Provides a balanced, standard level of exposure, image processing, and contrast.
- **Low Light** - Designed for environments with dim lighting, such as indoors or evening. Settings are adjusted to capture more light, reduce noise, and improve visibility.
- **HDR** - Designed to capture environments with a wide range of brightness levels.

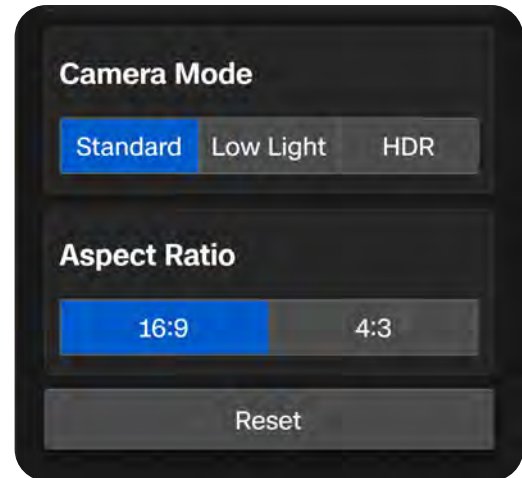

Aspect Ratio

Sets the shape and framing of your video.

- **16:9** - Provides a wider, broader field of view.
- **4:3** - Provides greater FOV in the vertical axis, resulting in more square-shaped framing. Images are taller, as opposed to wider.

VT300-L Sensor Package Flashlight

The VT300-L sensor package comes quipped with an onboard flashlight, providing effective illumination up to 10 ft (3 m) and enabling inspections in low-light environments.

Select the on-screen flashlight icon to turn the flashlight on or off in flight.



NOTE: The flashlight can only be controlled during flight and will not be operational on the ground nor during launch and landing.



WARNING: When using the flashlight on the VT300-L sensor package, do not stare directly into the light at any range for any extended period of time.



WARNING: After prolonged use of the flashlight, your sensor package may be hot to the touch and could present a serious burn risk. After landing, wait for your sensor package to cool down before handling.



Thermal Camera

The thermal camera with Skydio X10D includes a powerful suite of tools, such as radiometric capabilities, to assist you in a variety of use cases.

This section covers

Accessing Thermal Options

Flat Field Correction (FFC)

Thermal Tools

Thermal Settings

Thermal Parameters

Accessing Thermal Options

Quickly access your Thermal Tools and Settings using the quick action button located on the right side of the Flight Screen.

Step 1 - Select Thermal Settings

Easily enable some settings using the quick actions that appear, or access the full menu.

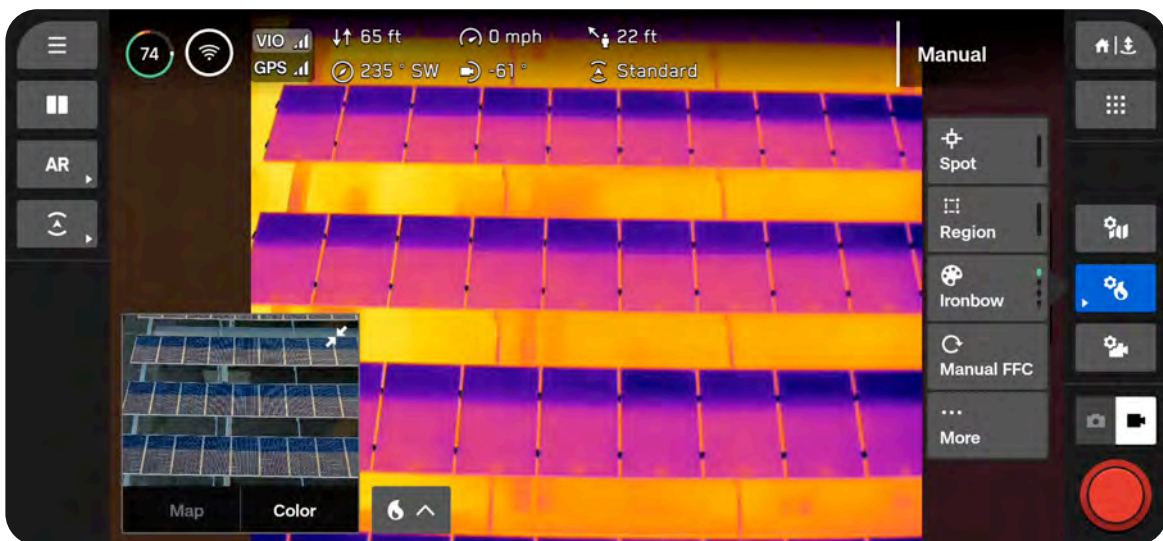
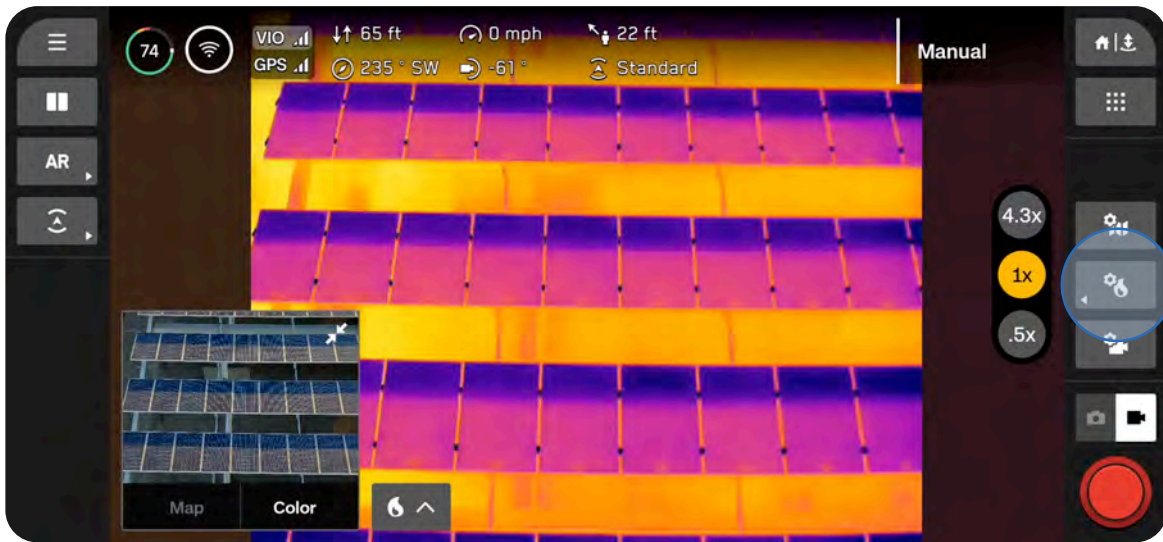

Thermal Camera

Step 2 - Select More

Use the tabs at the top to customize your Tools, Settings, and Parameters.

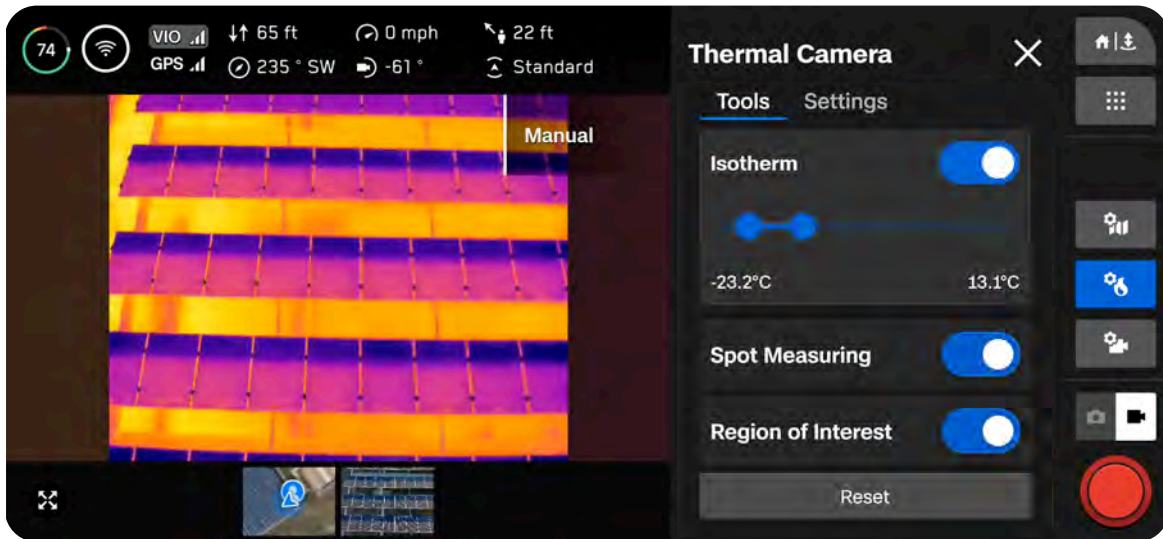
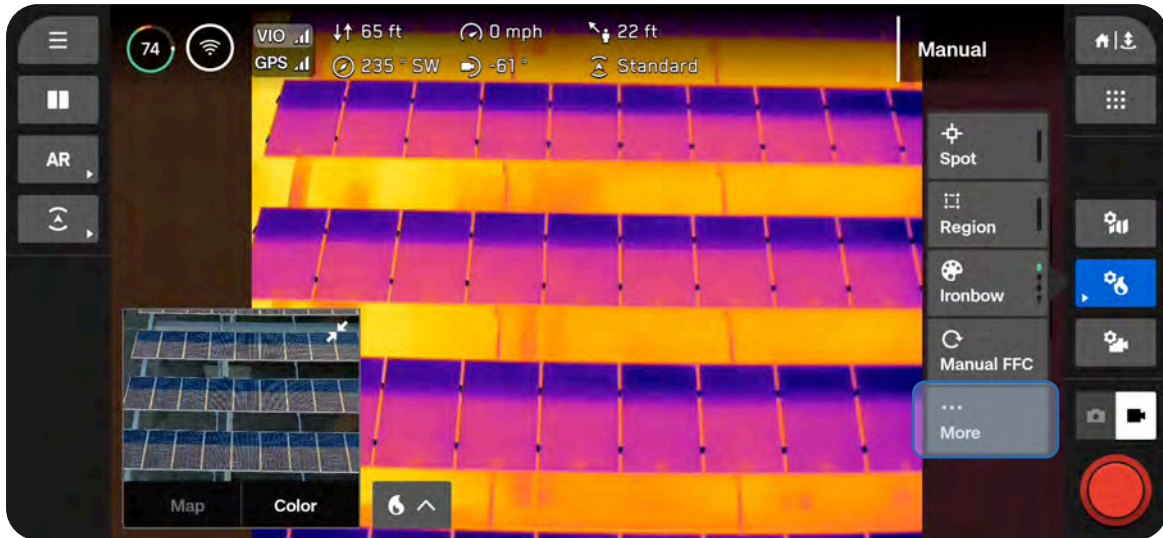

Flat Field Correction (FFC)

Flat Field Correction (FFC) mitigates and compensates for errors that build up over time during the thermal camera operation. This is performed in the background automatically at lower zoom levels, however, you can use the Thermal Settings to manually perform FFC at any time.



NOTE: If you manually perform FFC, the actuation of the shutter may be noticeable on the image at higher zoom levels.

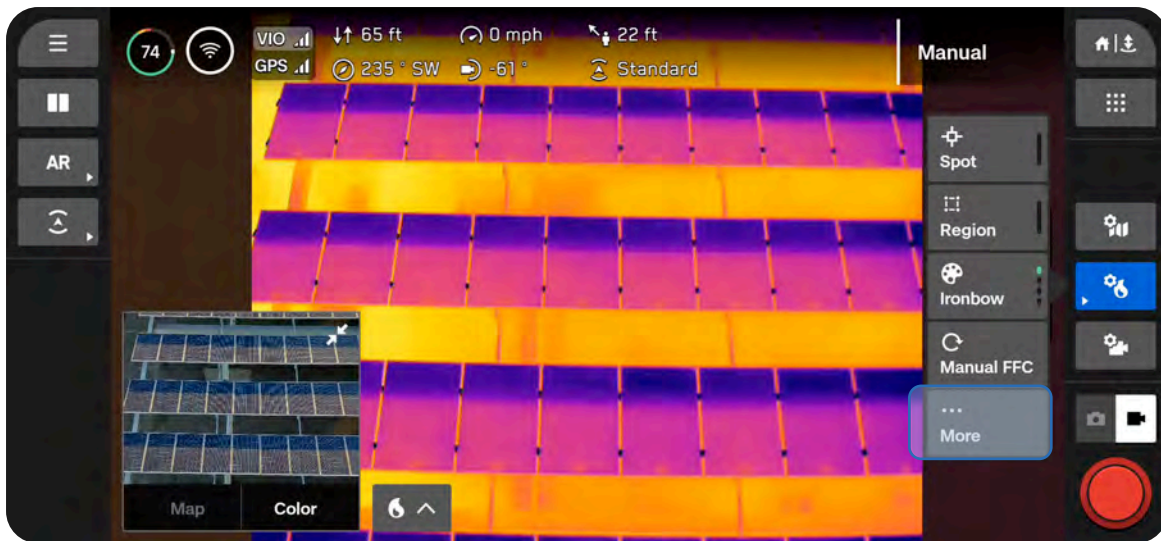

Thermal Tools

Isotherm

Allows you to set a range of temperatures to detect. Use this setting to omit unwanted data outside of the specified range.

The defined range will appear as the currently selected palette.

- Temperatures outside of the defined range will appear as the default White Hot or Black Hot palette
- If White Hot or Black Hot are currently selected, the temperatures in the Isotherm range will default to Rainbow

Spot Measuring

Enable to display the specific temperature value of an object on-screen as you drag your finger on-screen.

- Tap or drag your finger across the screen to view temperatures

Region of Interest

Enable to display an on-screen box that detects the minimum, maximum, and average temperatures within the outlined area

- **H** represents the highest temperature detected
- **L** represents the lowest temperature detected
- **A** indicates the average temperature detected
- Select the edges of the box to resize, or use the arrows to drag the box to a different location

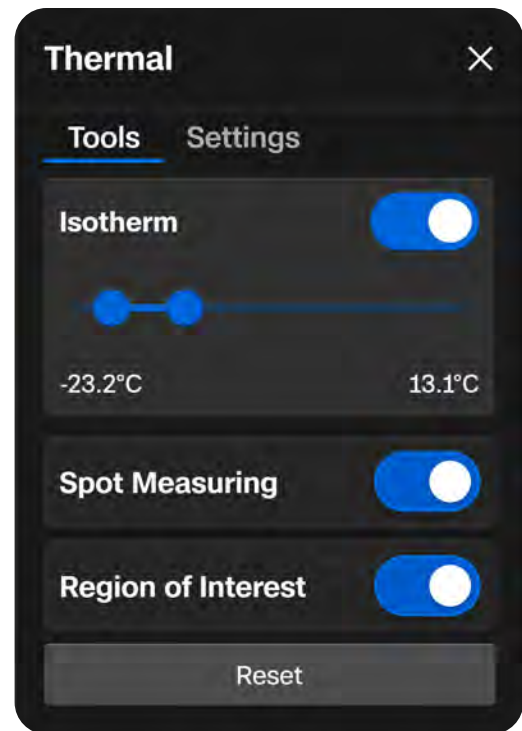

Thermal Camera

Spot Measuring

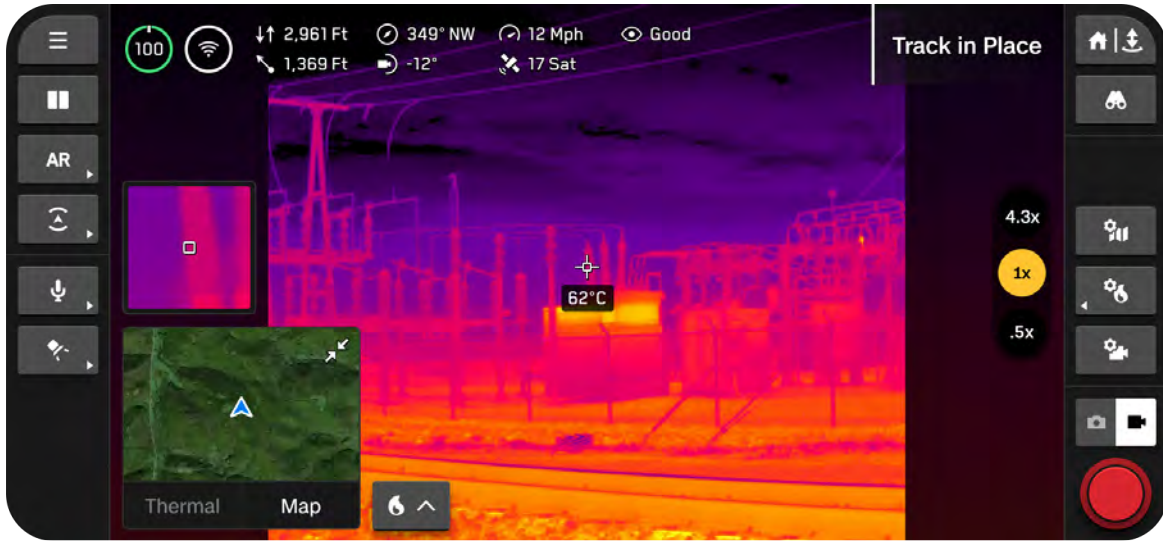

Region of Interest

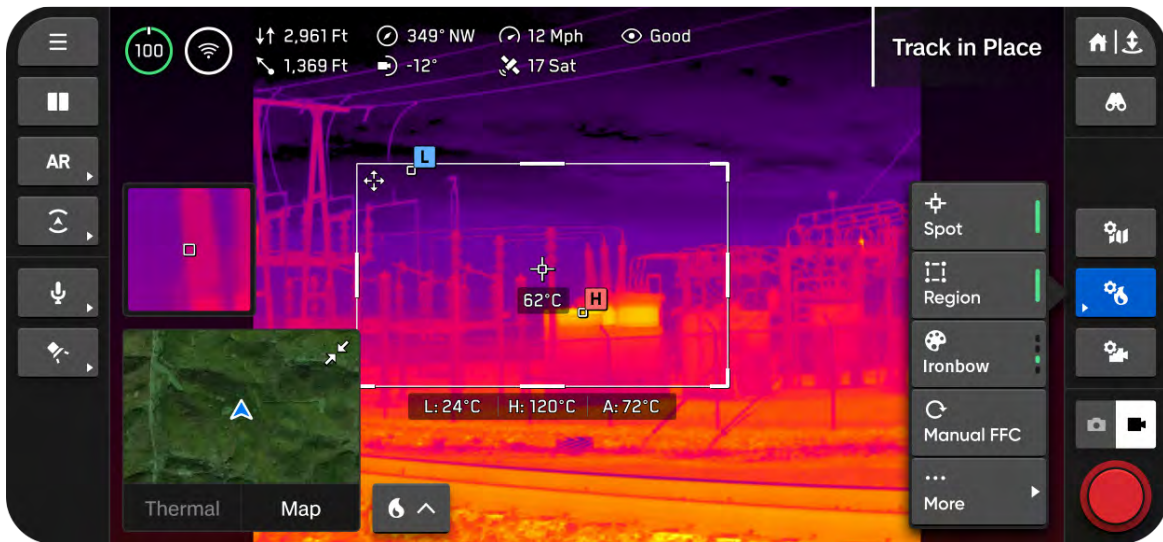

Thermal Settings

Color Palette

Visual representations of temperature variations captured by a thermal camera

Ironbow - Quickly identify varying temperatures and spot thermal anomalies. Displays a specific range of colors, from blues to reds, which indicate different temperature levels.

- Warmer objects are presented in lighter colors and colder objects in darker colors

Rainbow - Uses the colors of a traditional rainbow to distinguish between subtle variations in temperature levels.

- Covers a broader range of colors without emphasizing specific temperature ranges

White Hot - Provides a clear visualization of temperature variations without a variety of colors.

- Brighter, whiter colors indicate warmer temperatures
- Darker colors represent cooler temperatures

Black Hot - Displays the inverse of a White Hot palette.

- Brighter, white colors indicate cooler temperatures
- Darker, black colors represent warmer temperatures

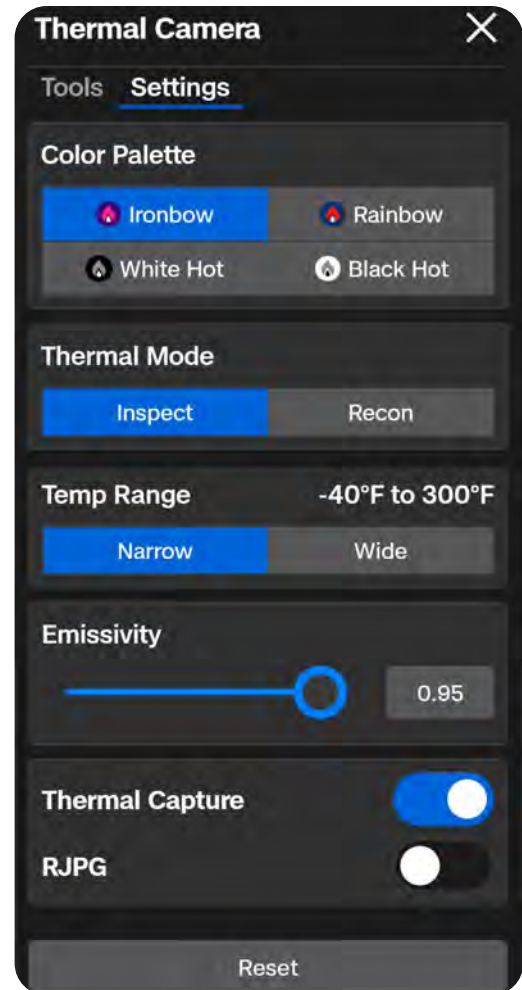

Thermal Camera

Thermal Mode

Adjust the signal amplification from the camera sensor to enhance temperature differences in an image.

Recon - Tuned to increase the contrast between the overall scene and targets. Best for search and rescue or situational awareness use cases. Recon helps differentiate the scene from things like people, vehicles, or animals.

Inspect - Tuned to decrease the overall contrast so that temperature anomalies are easier to identify in inspection use cases. This makes it easier to not only see the anomaly, but help track the source from the heat signature.

Custom - Allows you to fine-tune your Gain, High Tail, and Low Tail settings. Select Inspect or Recon as your Base Mode, then adjust your Gain, High Tail, and Low Tail settings from there. These settings will persist across flights and will be applied each time you select Custom as your Thermal Mode.

- Gain - Artificially increases contrast of areas with similar temperatures
- High Tail - Adjust saturation of the hotter items in the scene
- Low Tail - Adjust saturation of colder items in the scene

Temp Range

Select the range of temperatures Skydio X10D will detect.

Narrow - Detects temperatures ranging from -40°F to 302°F (-40°C to 150°C)

Wide - Detects temperatures ranging from -40°F to 662°F (-40°C to 350°C)

Thermal Capture

Enable to capture thermal images as JPG files.

RJPG - When enabled, your drone will capture a Radiometric JPG in addition to a standard JPG. A Radiometric JPG includes the radiometric data within the photo file.

Thermal Parameters

Emissivity

The measure of how efficiently an object emits thermal radiation. Adjust to match the camera readings to the true temperature of the object.

- Higher values means the camera is more sensitive to temperature variations
- Lower values means the camera is less sensitive to temperature variations

Surfaces that are better emitters (higher emissivity) provide more reliable temperature readings. For example, black electrical tape, rusted or oxidized surfaces, bodies of water, or human skin all absorb and emit energy. Set your emissivity high for these types of surfaces.

Reflective surfaces are not good emitters (low emissivity) and therefore not as reliable to measure. Stainless steel, shiny surfaces, or reflective windows tend to have a low emissivity. Set your emissivity low for these types of surfaces, but we recommend gathering your reading from a higher emissivity surface whenever possible.

Humidity

Set your humidity to accurately reflect the environment you are flying in. This should be the humidity between the sensor and the target.

Humidity is an important parameter to set because your thermal sensor will detect atmospheric conditions like humidity (and distance) which can affect the accuracy of your reading.

Distance

Set your distance to accurately reflect the range from your thermal sensor to the target.

The further away the target, the more atmosphere your thermal camera will pick up along the way to the target which can affect the accuracy of your reading.

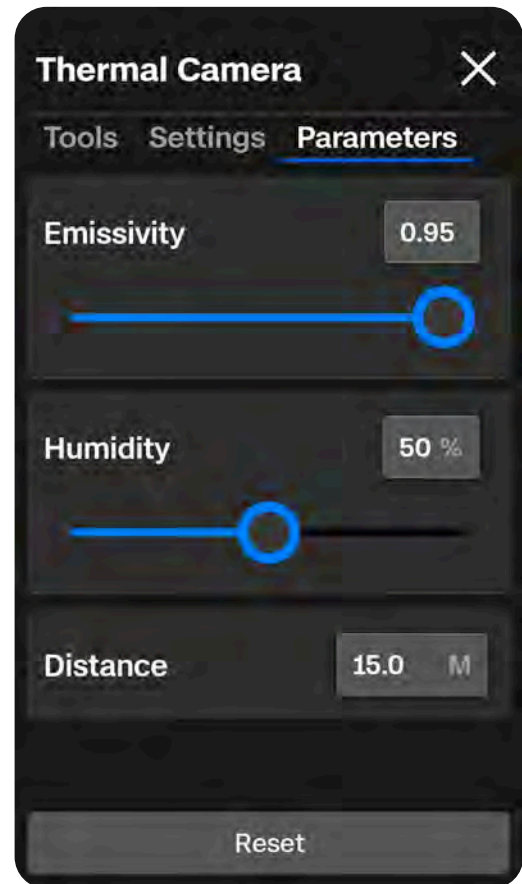



Flight

Review safe flight practices and important information you need to know while in flight.

This section covers

Preflight Inspection

Flight Screen

Changing Flight Modes

Launching

Battery Indicator

Flight Skills

Flying at Night and Flying in Precipitation

Returning and Landing

Preflight Inspection



WARNING: Carefully inspect your drone and environment before launching to ensure a safe flight.

- **Inspect the chassis** to ensure it is free of damage.
- **Inspect drone arms** and verify they are fully extended and free of damage.
- **Inspect the battery** and confirm it is securely seated prior to launching. Skydio X10D uses magnets to seat the battery which may attract metallic debris. Ensure the connector pins are free of debris or damage.
- **Clean the camera lenses and time of flight sensor** with a clean microfiber cloth. Cameras should be dust and smudge-free before flight.
- **Fan out the propellers and inspect** to verify they are firmly attached and properly seated in the motors and spin freely. Propellers should be free of cracks or damage. Do NOT fly with damaged propellers.
- **Inspect the sensor package** before powering on and ensure it moves freely and is not damaged, and **remove the Sensor Package Lock** before flying.
- **Ensure all USB-C and microSD card seals are secured** over the ports.
- **Check your surroundings** before launching to ensure a safe environment for flight.
- **Point the controller cover/antennas toward the drone** for maximum wireless performance.
- **Verify batteries are fully charged** before flying.
- **Check for drone and controller updates** before flying.

Maximum Wireless Performance

For maximum wireless performance when flying over a direct link, always maintain a direct line of sight between the controller and Skydio X10D. Point the controller cover toward the drone, especially when flying at close range high altitude.

Signal strength and maximum control range may be affected when flying in areas with electromagnetic interference.

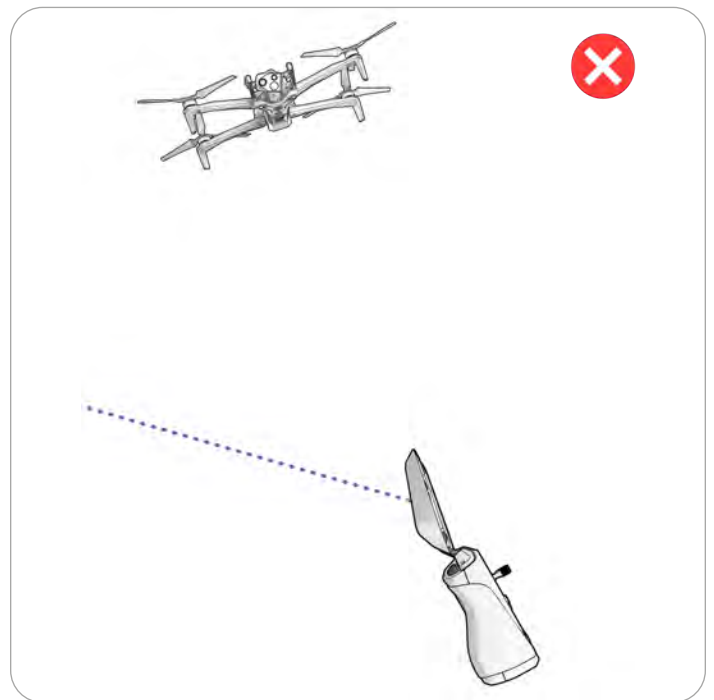
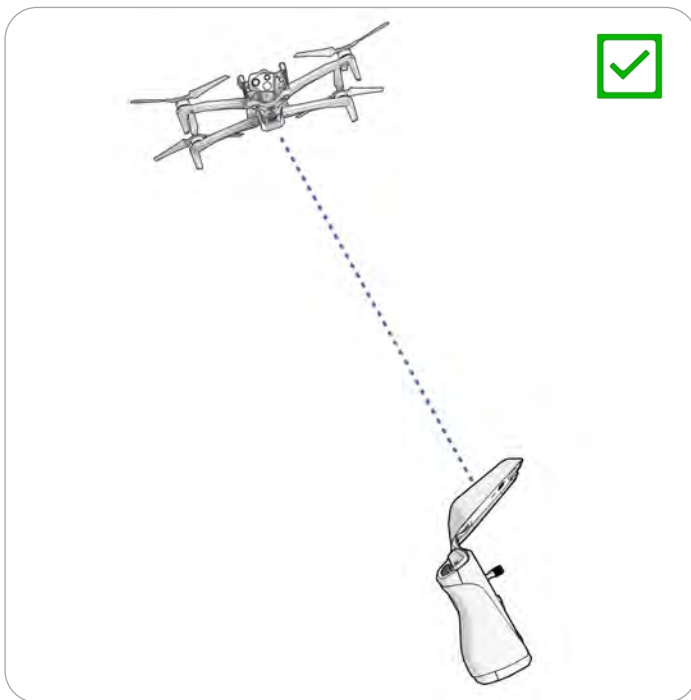

Connecting Devices

Step 1 - Power on Skydio X10D and the X10D controller

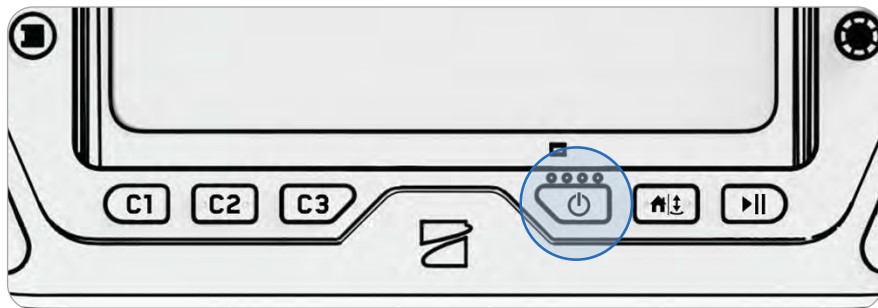
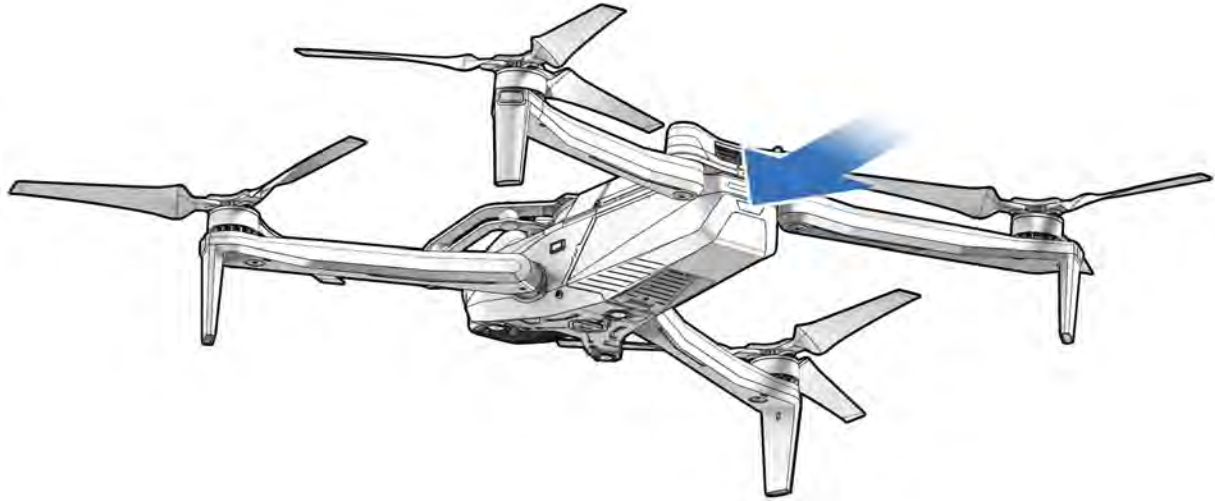

Flight

Step 2 - Wait for devices to connect

A drone and controller that were previously paired will automatically connect.

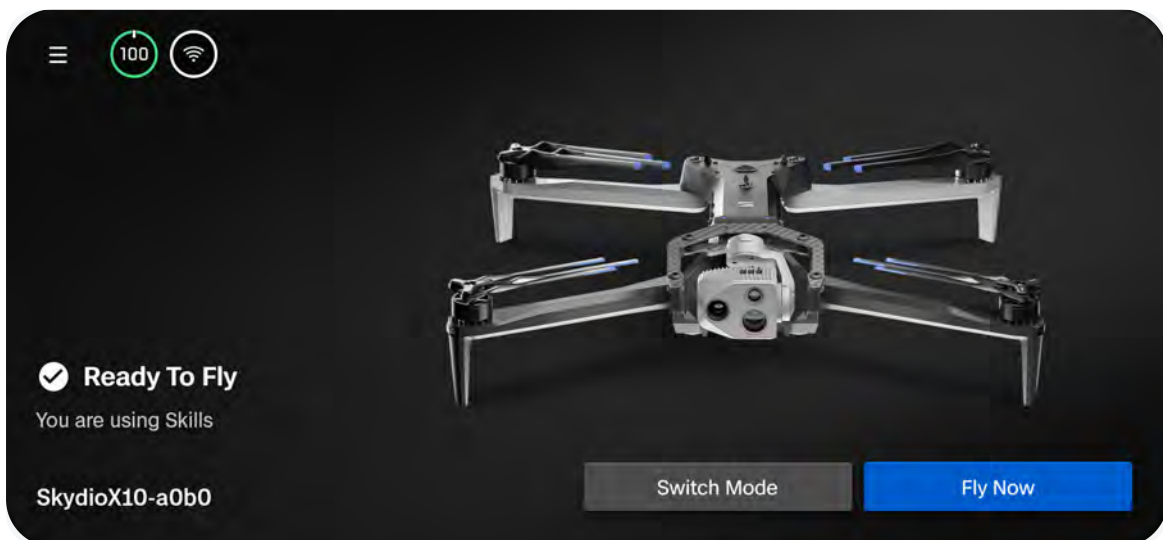

Launching



NOTE: Before your first flight, make sure to set your Return and Lost Connection Behaviors (Global Settings > Return). Scan the QR Code for more information about Return and Lost Connection Behaviors.



Step 1 - Find a clear, safe area to launch

Find a clear, safe area to launch and place your drone on a stable surface. Leave about 10 ft (3 m) clearance in all directions.

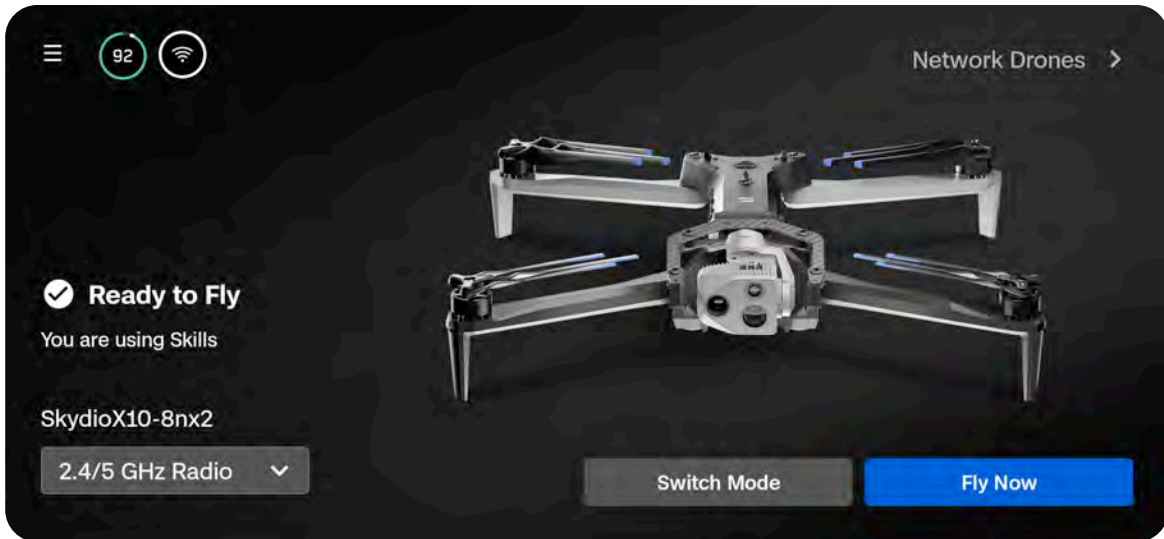

Flight

Step 2 - Launch

Your drone will rotate 360° during launch to calibrate its Inertial Measurement Unit (IMU) and navigation system, climb to 10 ft (3 m), and hover.

Option 1 - Drag the on-screen slider

The drone will initiate launching when you lift your finger away from the screen.

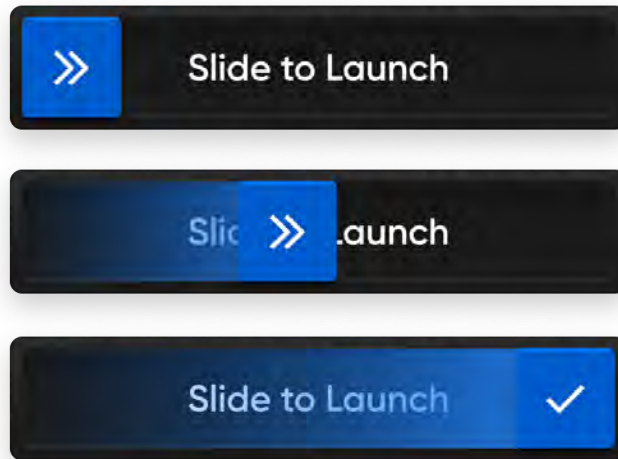

Option 2 - Press and hold the Launch/Land button on the controller

The drone will initiate launching when you see the on-screen check mark.

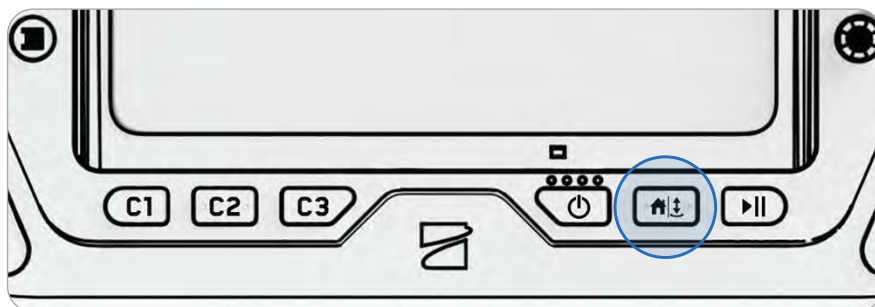

WARNING: Obstacle avoidance is disabled when the drone is below 10 ft (3 m) during landing. Exercise extreme care to avoid injury or damage. Do not touch spinning propellers.

Flight

Step 3 - Acquire GPS Lock

The GPS indicator in the telemetry bar will spin until the drone has acquired GPS Lock and established heading.

When the **Weak GPS Alt Limit** toggle is enabled, your drone will not be able to ascend above 66 ft (20 m) when GPS is weak.

Fly laterally to acquire a GPS lock and ascend above 66 ft (20 m).

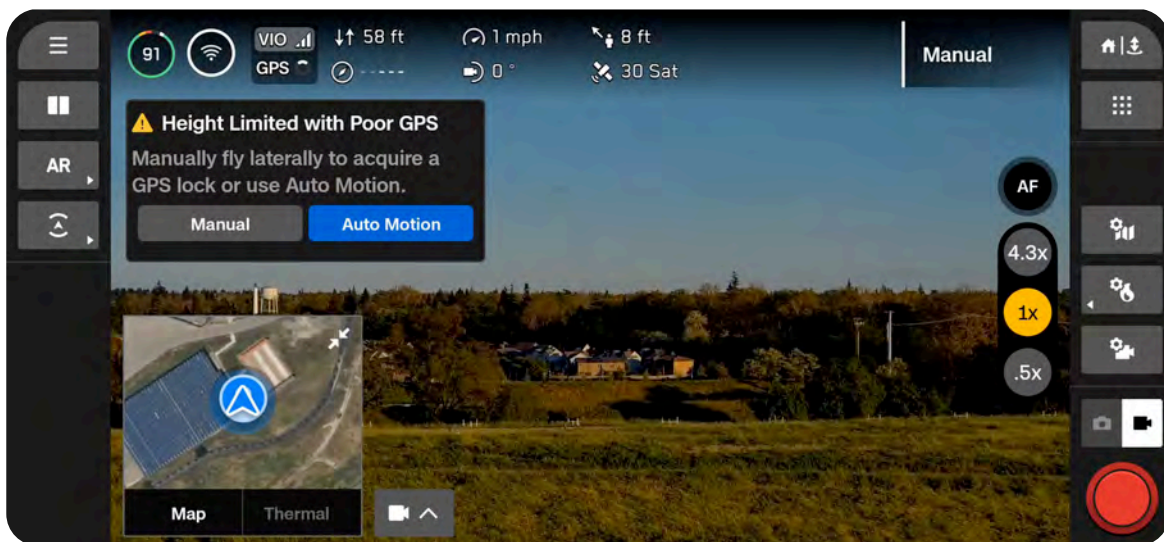

Hand Launching

Launching and landing Skydio X10D from your hand is a quick and convenient way to start or end your flight, particularly if you are not in a clear, level area. For your safety, always use caution when hand launching. This maneuver is dangerous and should not be attempted in unstable environments, such as during high winds or while standing on a moving vehicle or boat.



WARNING: Obstacle avoidance is disabled when the drone is below 10 ft (3 m) during landing. Exercise extreme care to avoid injury or damage. Do not touch spinning propellers.

Step 1 - Ensure you have clearance above and in front of you

Step 2 - Hold the drone away from you (sensor package facing away from your body)

- Lightly grip the battery
- Keep the drone level, still, and at arm's length from your body
- Your fingers should be below the Skydio X10D chassis and away from the propellers at all times
- Ensure your hand steady

Step 3 - Launch

Press and hold the Launch Button on the X10D Controller. Slowly relax your grip as Skydio X10D launches.

- Do not push or throw the drone up in the air
- Keep your hand still - the drone will slide off your palm and take flight on its own



TIP: Quick Launch allows you to use the battery power button to hand launch your Skydio X10D so that you do not have to balance the controller in one hand and your drone in the other. Press the battery button four times to initiate the launch.

Flight Screen

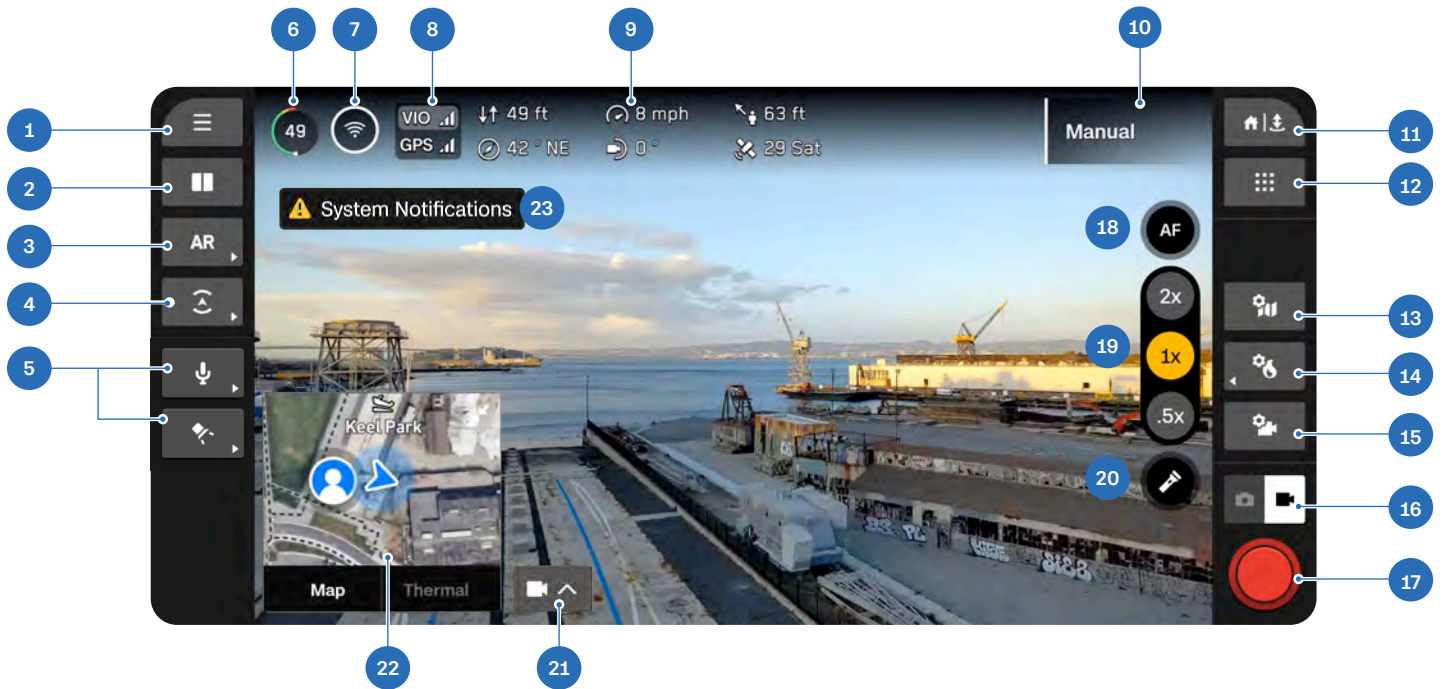

- | | |
|--|---|
| <ul style="list-style-type: none"> 1. Global Settings 2. Display Layout 3. AR Quick Actions 4. Obstacle Avoidance Quick Actions 5. Attachments Quick Actions* 6. Drone Battery 7. Signal Strength 8. VIO/GPS Indicator 9. Telemetry (customizable) 10. Active Flight Skill 11. Return/Land 12. Flight Skills | <ul style="list-style-type: none"> 13. Map Settings 14. Thermal Settings 15. Camera Settings 16. Camera Mode 17. Shutter 18. Focus Control 19. Zoom 20. Flashlight On/Off (VT300-L Only) 21. Picture-in-Picture (PiP) 22. View Selector 23. Notifications |
|--|---|

**Only appears when you are currently using an attachment. Attachments coming soon.*

Battery Indicator

The battery percentage **dynamically changes** during your flight based on altitude and distance from the return location. Monitor the Battery Indicator while flying to understand how much battery is:

- Available for flight
- Available for return
- Required to land

The battery on Skydio X10D has the ability to warm itself in cold environments. For more information, read the Maintenance section.

Green indicates the battery capacity for nominal flight before the time limit required to safely return and land.

- Decreases as battery capacity diminishes
- Adapts based on your altitude and distance from the return location

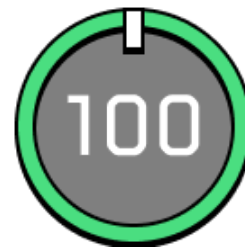

Yellow indicates how much battery is required to safely return.

- Adapts based on your altitude and distance from the return location



Red indicates how much battery is required to land.

- Adapts based on your altitude and distance from the return location

The lightning bolt indicates the battery is connected and charging.

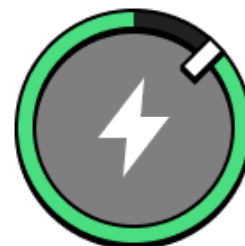

Flight

When battery capacity has less than two minutes of flight time available for landing, the indicator will change to a countdown.



Three dashes indicate the battery is disconnected.

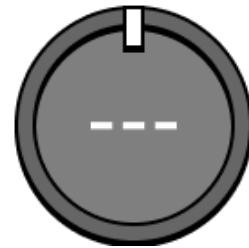

VIO/GPS Indicator



Indicates the health of the drone positioning systems, and which positioning system is actively being used (highlighted).

- **VIO** - Visual Inertial Odometry. This is the visual navigation system of the drone.
- **GPS** - Global Positioning System

VIO and GPS states: Healthy, Degraded, Failed, or Disabled

If both GPS and the drone's vision navigation system (VIO) become unreliable, Skydio X10D will enter Attitude Mode.



CAUTION: Monitor your GPS and VIO health in the telemetry bar. If VIO and GPS both drop below 2 bars of health, your drone will enter Attitude Mode.

Flight Skills

Skydio offers a range of manual and autonomous controls called **Flight Skills**. Select your desired skill and Skydio X10D will intelligently fly itself to assist with the task at hand.

By default, you will start in the Manual Flight Skill, which provides a traditional flying experience.

Base Skydio Flight Skills

Manual

Traditional flying experience. Obstacle avoidance settings will persist when flying manually, allowing Skydio X10D to route itself around obstacles, modifying any commands that could potentially cause a collision. Fly using Control Mode 1, Mode 2 (default), or Mode 3.

Orbit Point

Rotate around a user-selected point-of-interest in either a clockwise or counter-clockwise direction, keeping the point in the center of the frame. Set a GPS position on a map.

Track in Place

Initiate tracking a person or vehicle and Skydio X10D will hover in a fixed position, as if affixed to a virtual tripod. The drone will automatically yaw and adjust the sensor package pitch to maintain tracking. Tracking in both Color and Thermal is available.

Waypoints

Create and executive multi-waypoint GPS missions, preflight or postflight.



INFO: [Visit our website](#) for more information on additional Flight Skills available for purchase.

Changing Flight Skills

Step 1 - Select the Flight Skills icon

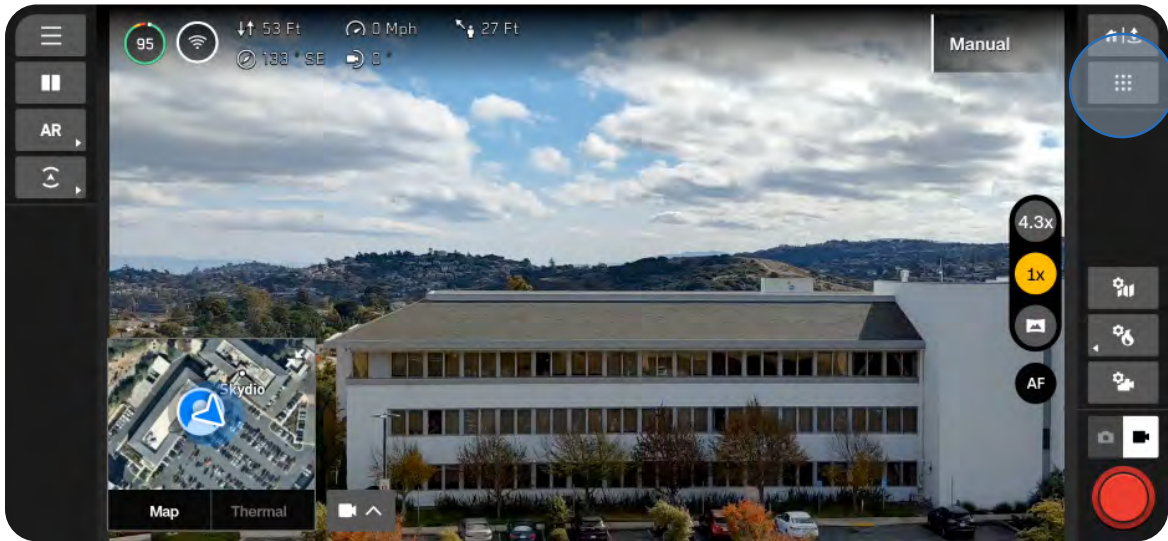

Step 2 - Select your Flight Skill

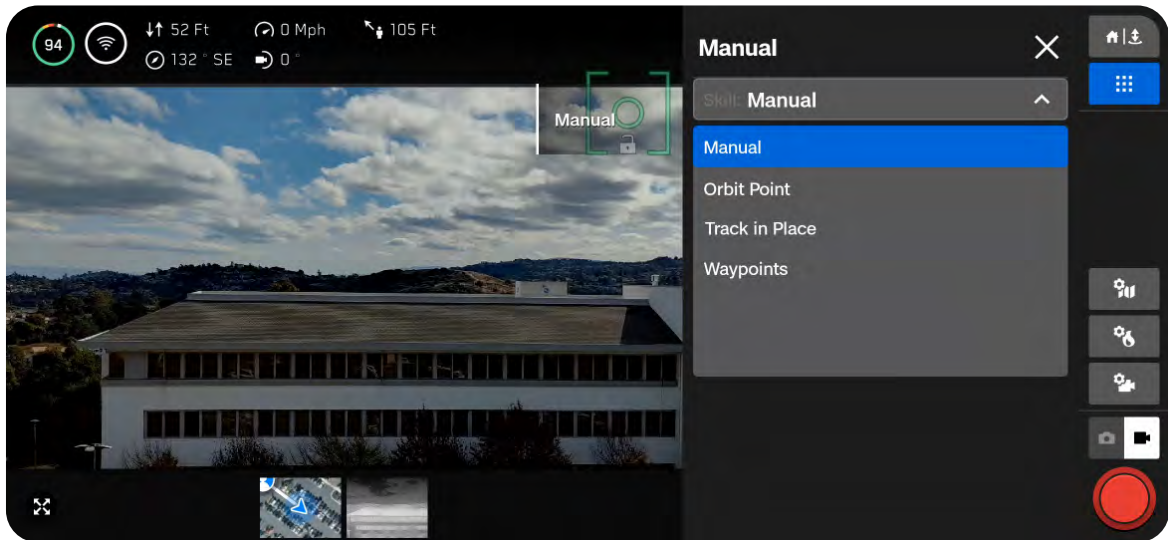

Flight

Step 3 - Adjust settings (optional)

Each skill may have its own adjustable settings which only affect the selected skill. If the selected skill has adjustable settings, they will appear below the skill name within the Flight Skills menu.

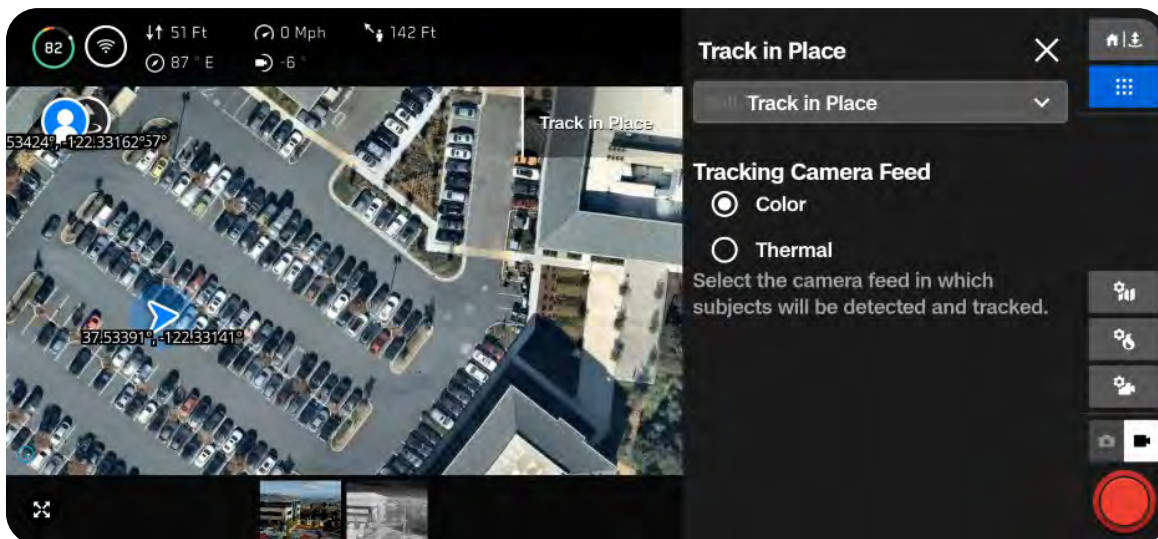

Flying at Night

Flying at Night without NightSense

When flying at night or in low light conditions without NightSense, Skydio X10D will primarily use GPS to navigate and obstacle avoidance will be disabled.

Step 1 - Enable Low Light mode

You will see an on-screen notification to enable Low Light mode if there is insufficient light. You may also select the Global Settings icon, select Sensing, then select Low Light.

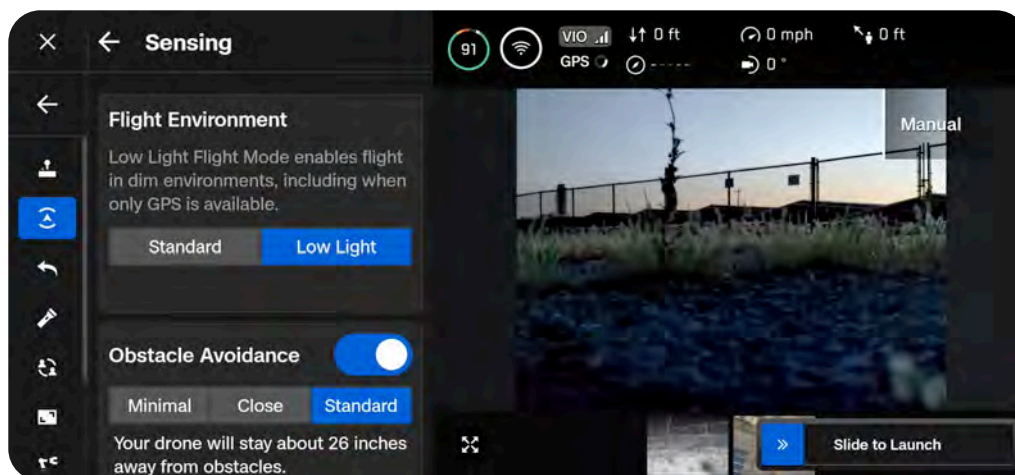
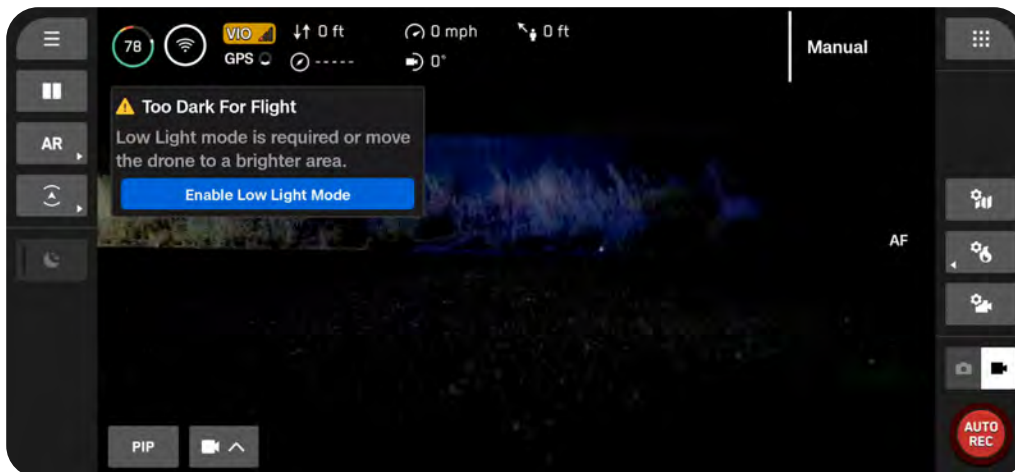

Flight

Step 2 - Configure your lighting settings

Improve visibility by enabling infrared or visible strobe lights. Select Lighting then toggle on RGB (default navigation lights), Infrared, or Strobe lights. Infrared and Strobe lights cannot be on at the same time.

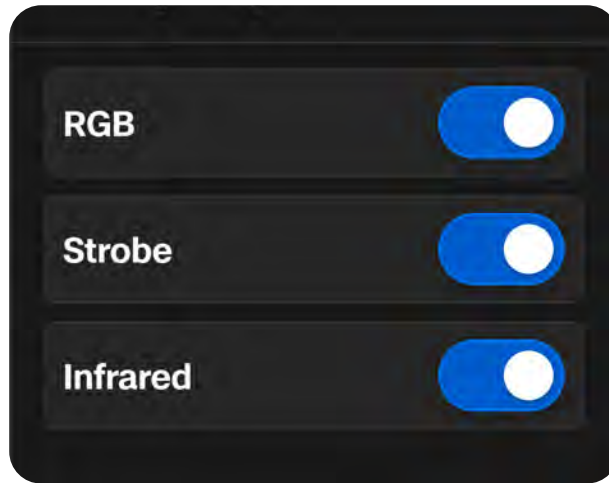

Flight

Step 3 - Calibrate your drone

Exit the Global Settings menu, then select Fly Now. Hold your drone from the bottom with the camera facing away from your body and wave from side to side to calibrate. You will see an on-screen message when calibration is complete.

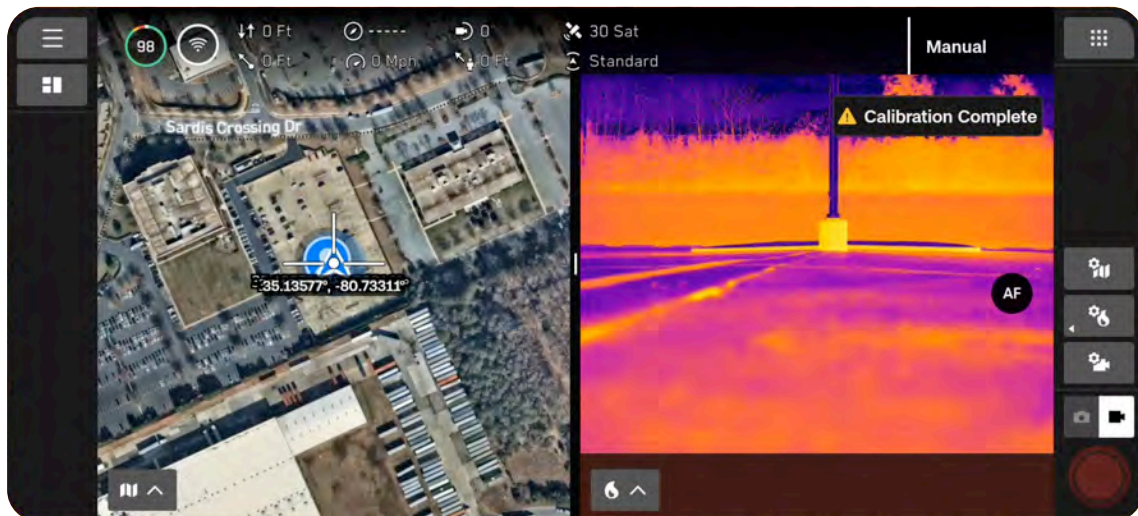
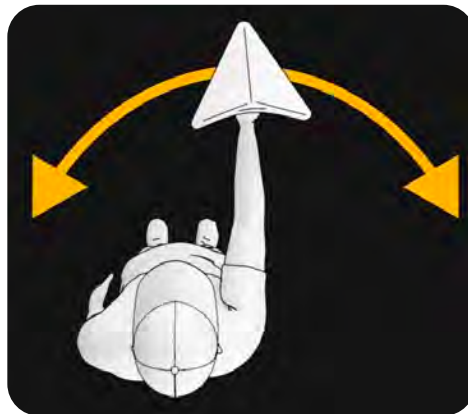
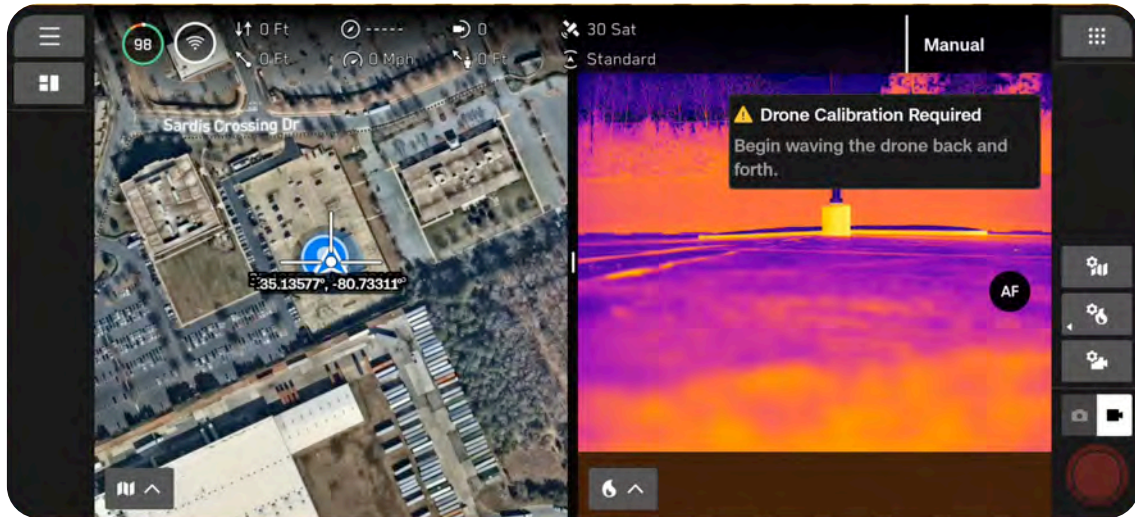

Flight

Step 4 - Launch Skydio X10D

Your drone will rotate 360° during launch to calibrate its Inertial Measurement Unit (IMU) climb to 16.5 ft (5 m), and hover. Obstacle avoidance will be disabled.

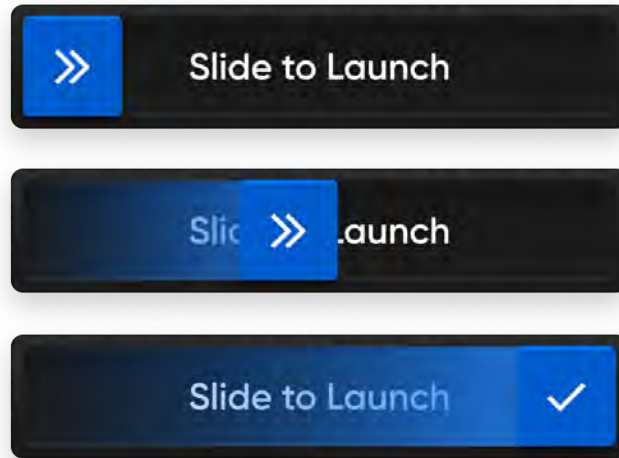

WARNING: Obstacle avoidance is disabled in Low Light mode without NightSense. Fly with extreme caution!

Flying at Night with NightSense

The Skydio NightSense attachments and add-on software allow you to leverage Skydio X10D visual navigation and obstacle avoidance capabilities even when flying at night.

The set of two NightSense attachments cast a light above and below your drone. This light illuminates the area, unlocking Skydio visual navigation and obstacle avoidance when flying at night and in low-light conditions.



WARNINGS:

- *After prolonged use of the NightSense attachments, they may be hot to the touch and could burn your hand. After landing, wait for your attachments to cool down before handling.*
- *Do not stare directly into your NightSense modules at close range. NightSense attachments, both Visible and Infrared, may cause eye damage if held closer than an arm's reach for 30 seconds or more.*
- *Due to potential burn risk and eye damage, Skydio does not recommend Hand Landing your drone while using NightSense.*

Step 1 - Install your attachments

Visit [Getting Started with NightSense for Skydio X10D](#) for step-by-step installation instructions.

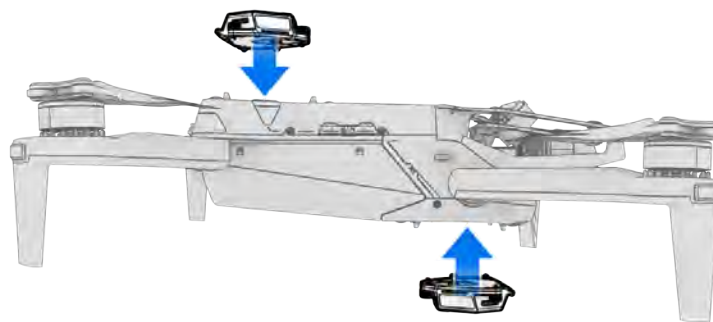

Flight

Step 2 - Enable Low Light mode

You will see an on-screen notification to enable Low Light mode if there is insufficient light. You may also select the Global Settings icon, select Sensing, then select Low Light.

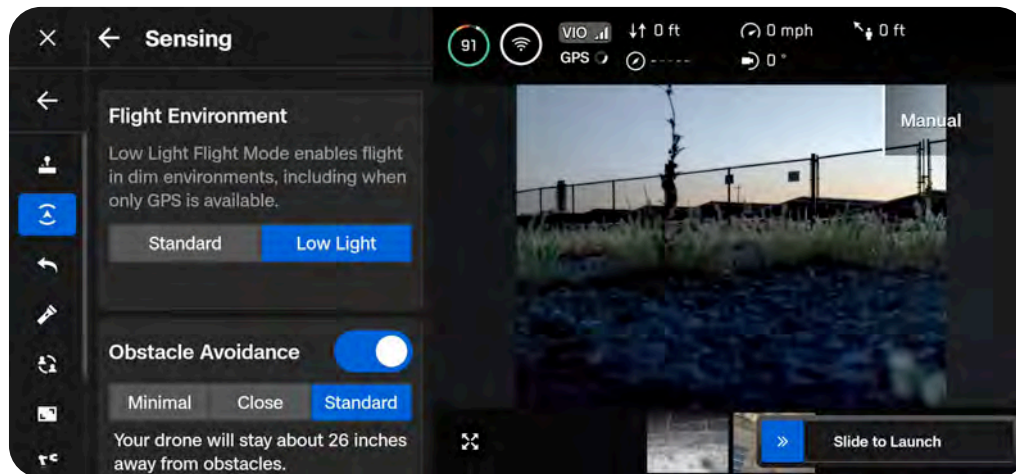
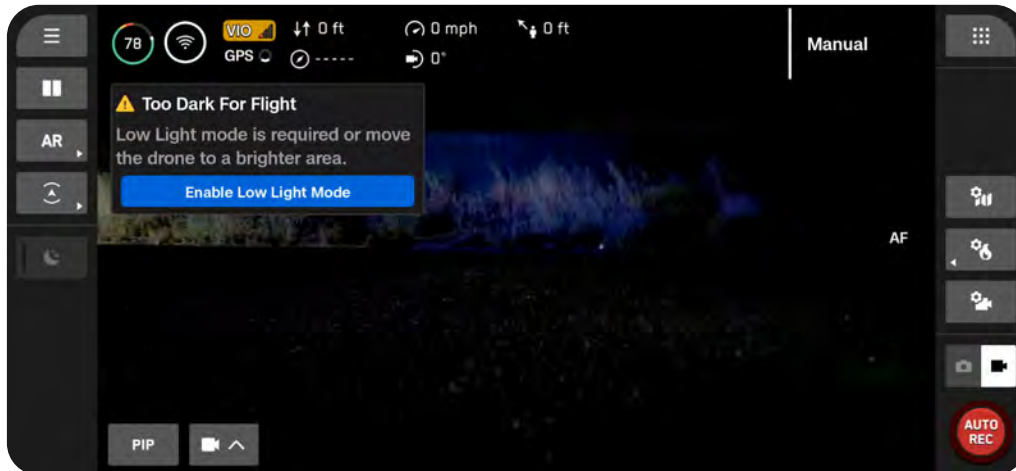

Flight

Step 2 - Configure your lighting settings

Improve visibility by enabling infrared or visible strobe lights. Select Lighting then toggle on RGB (default navigation lights), Infrared, or Strobe lights. Infrared and Strobe lights cannot be on at the same time.

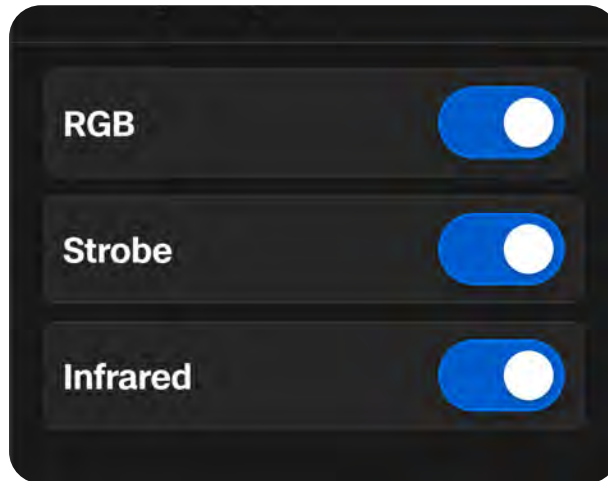

Step 3 - Enable NightSense

By default, NightSense will automatically turn on when entering Low Light mode. Use the left sidebar quick action to subsequently turn NightSense on or off. The visible or infrared lights from the NightSense attachments will illuminate the area around the drone.

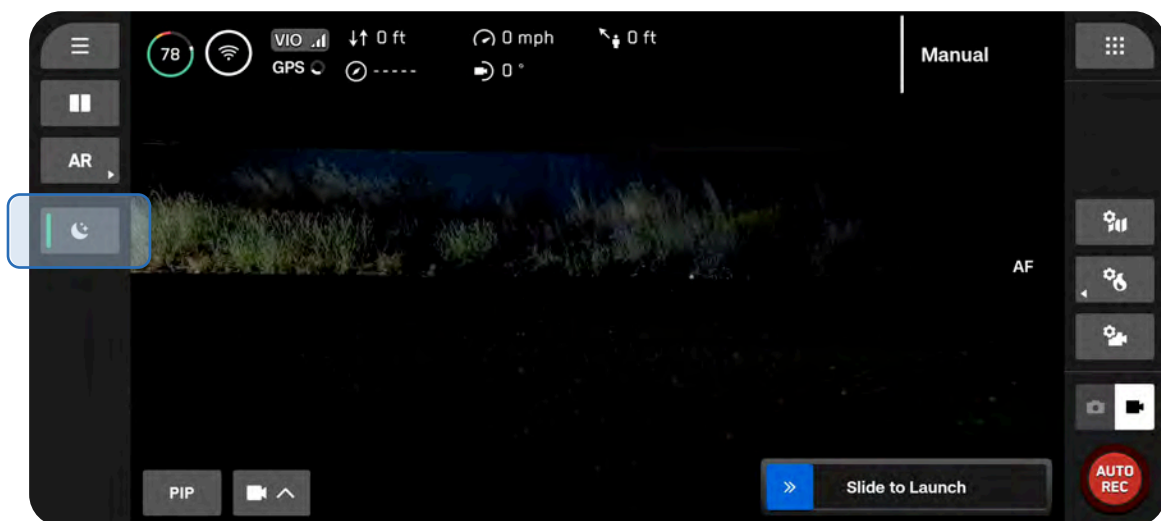

Flight

Step 4 - Launch Skydio X10D

Your drone will rotate 360° during launch to calibrate its Inertial Measurement Unit (IMU) climb to 10 ft (3 m), and hover.

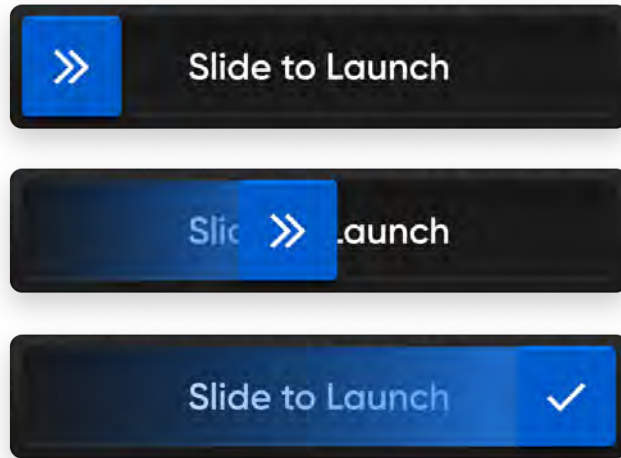

NOTE: Skydio X10D is limited to a max speed of 18 mph (8 m/s) with NightSense on.



INFO: For more information about flying with NightSense, including configuring settings visit: [Getting Started with NightSense for Skydio X10D](#).

Inflight Safety Considerations

Obstacle Avoidance

- **NightSense ON:** Obstacle avoidance is active when NightSense is on. Enable the AR Depth View to visually display where Skydio X10D detects obstacles in the environment, especially when using Infrared NightSense attachments, to assist with situational awareness.
- **NightSense OFF:** When in Low Light mode, obstacle avoidance is disabled. Take extra caution when piloting the drone to avoid obstacles and stay clear of people.

GPS Signal

- **NightSense ON:** When NightSense is on, visual navigation (VIO) is the primary navigation method, however if flying at high altitudes the drone will rely on GPS. Monitor your VIO and GPS health status inflight; if both VIO and GPS degrade the drone will enter Attitude Mode.
- **NightSense OFF:** Maintaining a strong GPS signal is paramount when operating X10D at night. If Skydio X10D loses GPS while in Low Light mode, and there is not enough ambient light for VIO, it will enter Attitude Mode.

Visibility

Improve visibility by enabling infrared or visible strobe lights. Skydio X10D strobe lights meet the FAA requirement of being visible at a distance of 3 statute miles.

Return Behavior

Review the return behavior height setting in the Global Settings menu.

NightSense OFF: Skydio X10D does not avoid obstacles when in Low Light mode and NightSense off, so you may want to set the drone's return height such that it will be above any potential obstacles.

Landing

When landing, use the controller joystick to descend down to 15 feet (4.6 meters), when you are ready to land, press and hold the LAND button on the screen or the controller. Do not hand launch or hand land at night.



WARNING: Due to potential burn risk and eye damage, Skydio does not recommend Hand Landing your drone while using NightSense.

Flying in Precipitation

Skydio X10D is IP55 rated and able to fly in light to moderate precipitation when **obstacle avoidance** is disabled. Skydio will primarily use GPS to navigate, so it is critical to have a strong GPS signal when flying in precipitation.



CAUTION: *Flight in icy conditions is not supported and may result in the loss of your drone.*

Quick Reference

Flying in precipitation during the day

- Select Standard as your Flight Environment
- Disable obstacle avoidance via the quick action or the settings menu
- Only fly with a strong GPS signal

Flying in precipitation at night

- Select Low Light as your Flight Environment
 - Disable obstacle avoidance, disable NightSense (if you have NightSense attachments installed)
 - Only fly with a strong GPS signal
-

Preflight

Step 1 - Ensure all rubber seals on the drone are securely closed

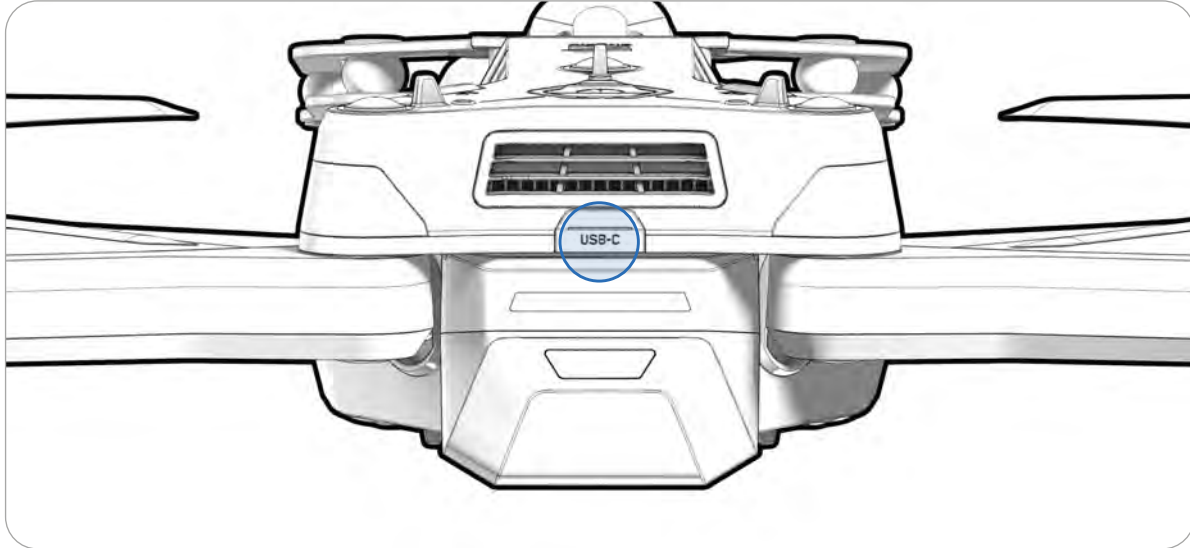

Step 2 - Select your Flight Environment

Select the Global Settings icon, select Sensing, then select Standard (flying in precipitation during the day) or Low Light (flying in precipitation at night).

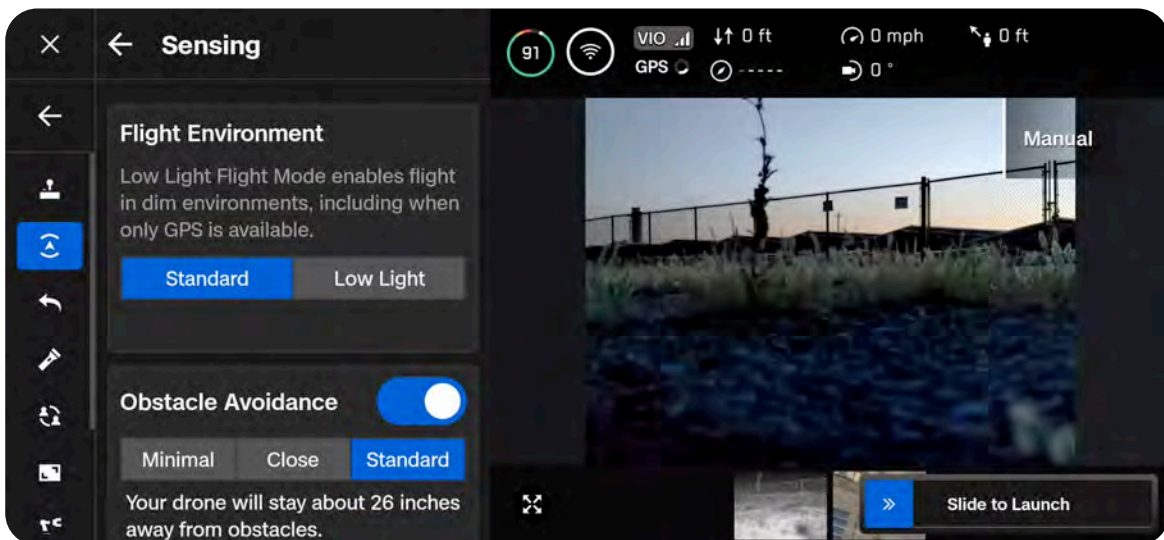

Flight

Step 3 - Calibrate your drone (if in Low Light mode)

Exit the Global Settings menu, then select Fly Now. Turn off NightSense (if on). Hold your drone from the bottom with the camera facing away from your body and wave from side to side in a straight line to calibrate. You will see an on-screen message when calibration is complete.

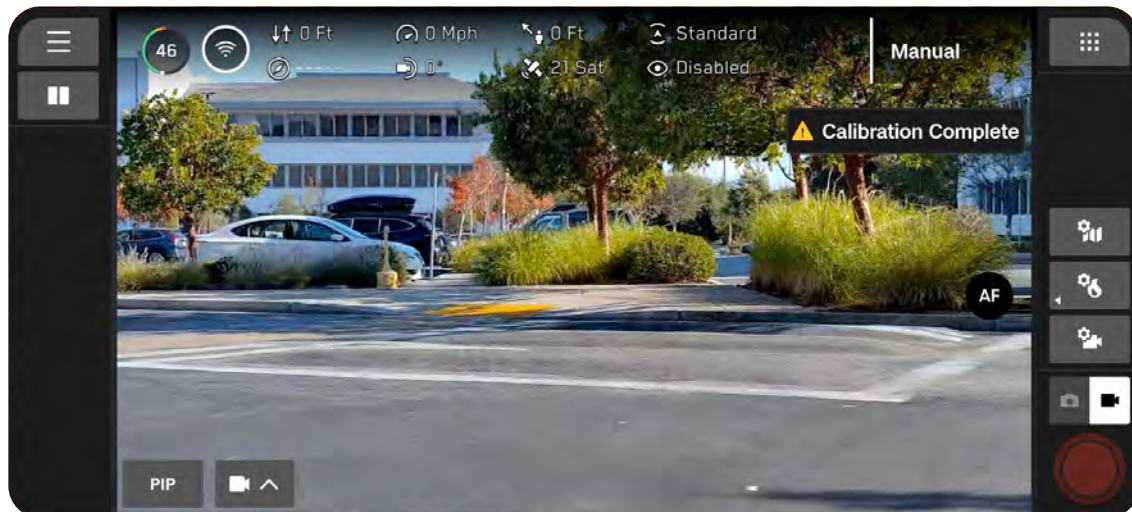
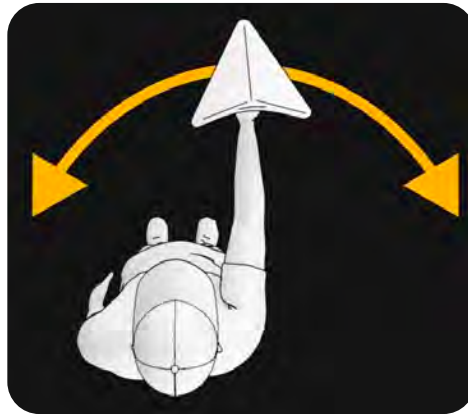
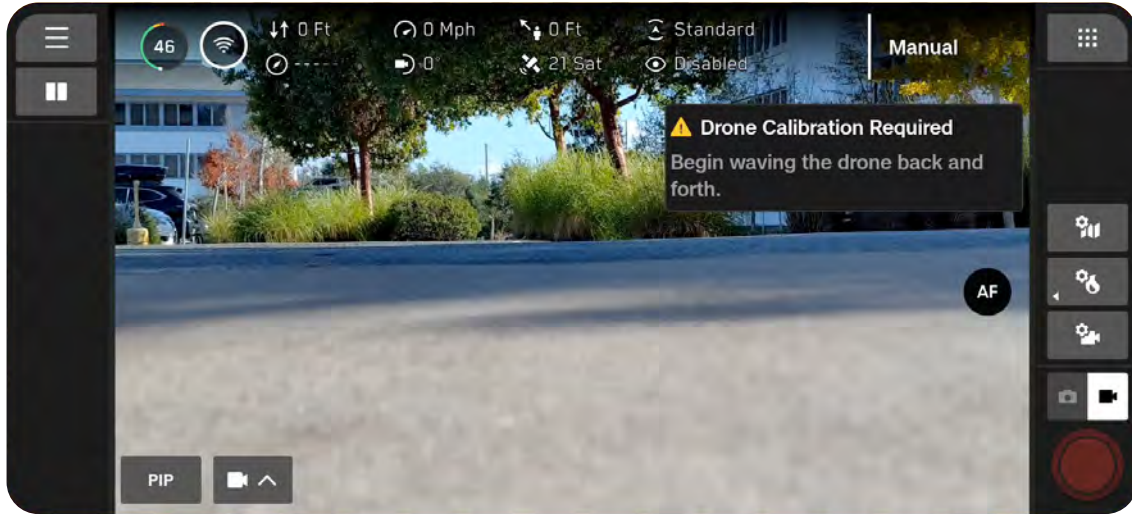

Flight

Step 4 - Disable obstacle avoidance

Disable obstacle avoidance from the quick action menu on the Flight Screen. Turn off NightSense if on.

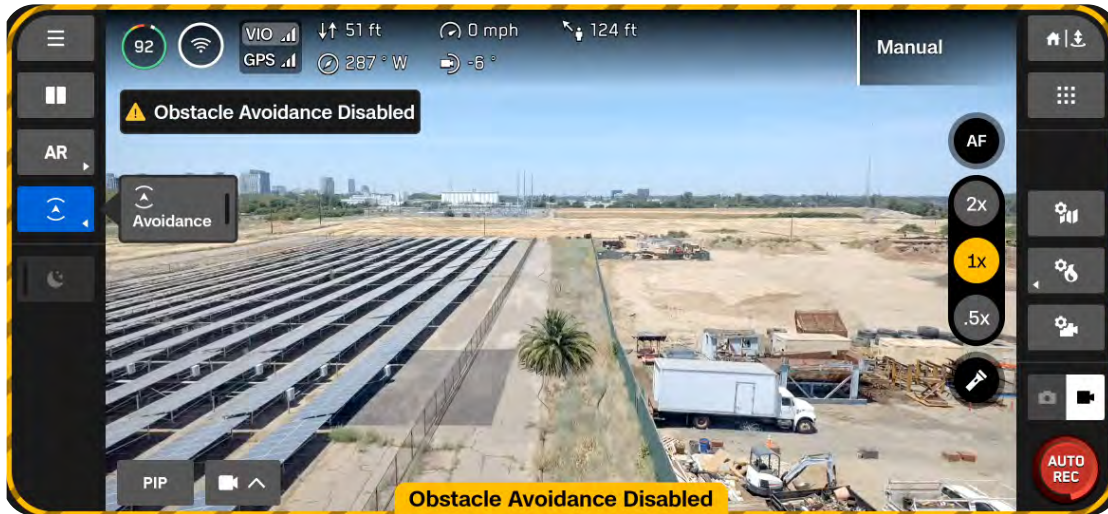

NOTE: If it begins to precipitate during a flight, disable obstacle avoidance inflight.

Step 5 - Launch Skydio X10D

Your drone will rotate 360° during launch to calibrate its Inertial Measurement Unit (IMU) climb to 10 ft (3 m), and hover. Obstacle avoidance will be disabled.

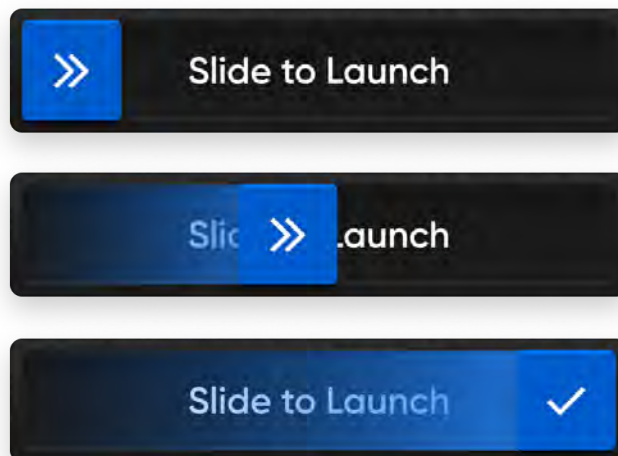

Step 5 - Lock controller touchscreen (optional)

To prevent touchscreen interference from precipitation, you have the ability to lock all touchscreen inputs. While holding the back button, press the D-pad down to lock or unlock the screen.

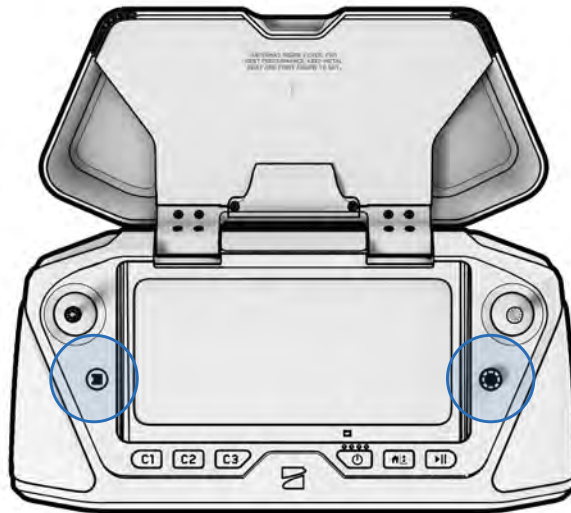

NOTE: You will not be able to make on-screen selections while touchscreen inputs are locked. Controller buttons are still functional and can be customized to perform specific actions (Controls > Input Mapping).

Inflight Safety Considerations

Obstacle Avoidance

When flying in precipitation, obstacle avoidance must be disabled. Take extra caution when piloting the drone to avoid obstacles and stay clear of people.

GPS Signal

Maintaining a strong GPS signal is paramount when flying in precipitation, since Skydio X10D is navigating primarily using GPS. If Skydio X10D loses GPS, it will enter Attitude Mode.

Visibility

Improve visibility by enabling infrared or visible strobe lights. Skydio X10D visible strobe lights meet the FAA requirement of being visible at a distance of 3 statute miles.

Wireless Range

Moisture in the air may significantly reduce wireless range.

Return Behavior

Review the return behavior height setting in the Global Settings menu. Obstacle avoidance must be disabled when flying in precipitation, so you may want to set the drone's return height such that it will be above any potential obstacles.

Landing

When landing, use the controller joystick to descend down to 15 feet (4.6 meters), when you are ready to land, press and hold the LAND button on the screen or the controller. Do not hand launch or hand land in precipitation.

Postflight

After flight operations in precipitation, follow all postflight steps before stowing your drone to ensure it is properly maintained and does not sustain any water damage.



CAUTION: Do not stow Skydio X10D while wet.

Step 1 - Power off Skydio X10D

Step 2 - Allow water to drain

Install the sensor package lock to hold the sensor package in place. Rotate the drone to allow water to drip out of all egress areas.

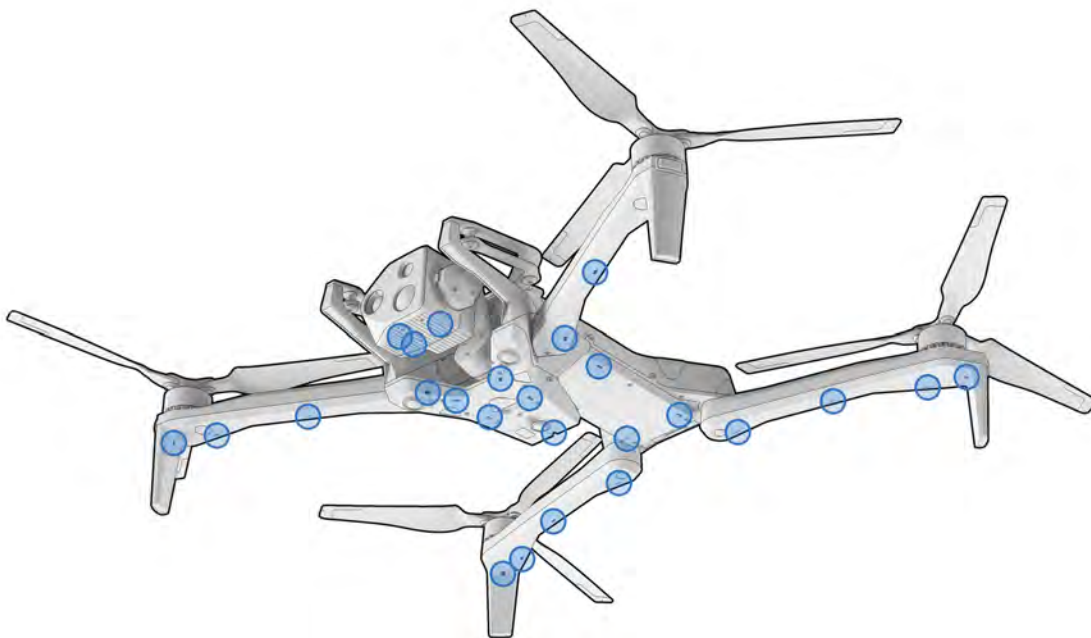

NOTE: Skydio is IP55 rated and able to fly in light to moderate precipitation. It is expected for water to enter different areas of the drone and draining postflight is normal. Sensitive components are protected.

Flight

Step 3 - Remove the battery



Step 4 - Wipe camera lenses clean

Use a microfiber cleaning cloth to wipe the lenses clean and prevent dried water spots from forming.

Step 5 - Air dry for a minimum of 12 hours

Leave the drone to air dry in a ventilated, temp-controlled environment with the arms deployed in an upright position. Do not open any seals, including the USB-C charge port, until after the drone is dry. Do not remove the sensor package or any attachments while the drone is wet.

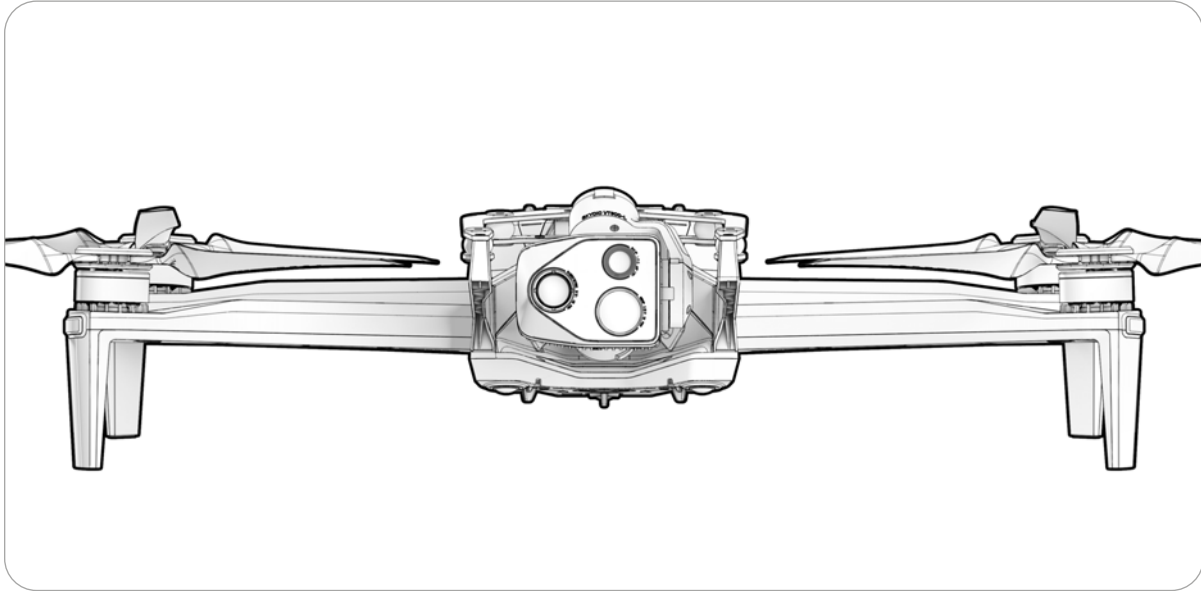

Returning and Landing



Scan for more information about Return and Lost Connection Behaviors.

Step 1 - Select the Return/Land button in the top right of your screen or on the controller

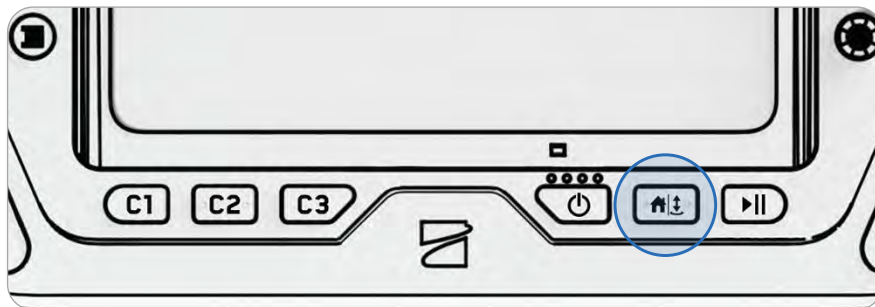
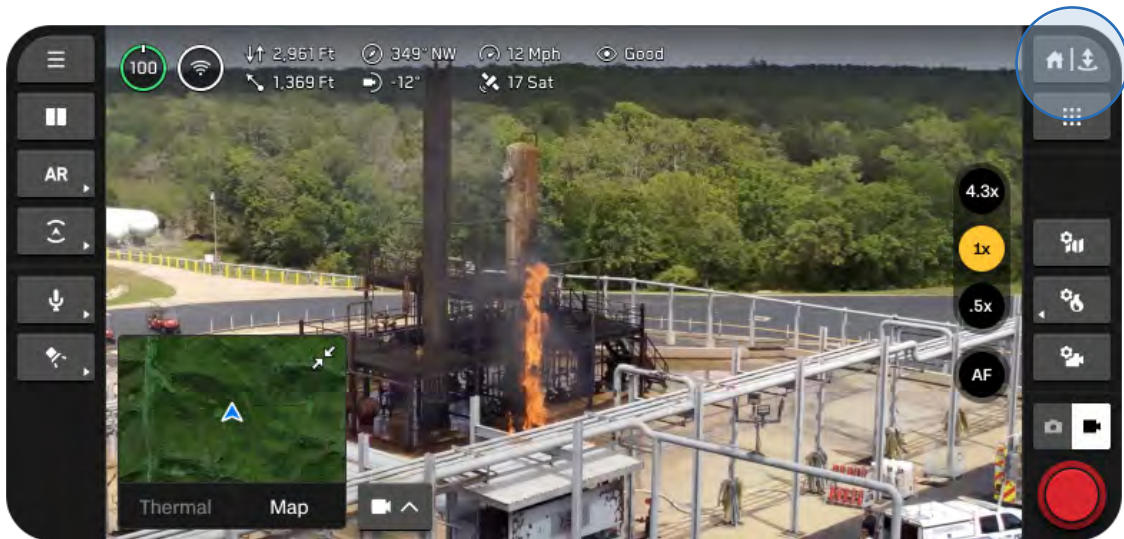

Flight

Step 2 - Choose your return location or land in place



Home

Returns to a Home Point previously set on the map (GPS required)



Launch

Returns to the Launch Point



Pilot

Returns to the location of the Skydio X10D Controller

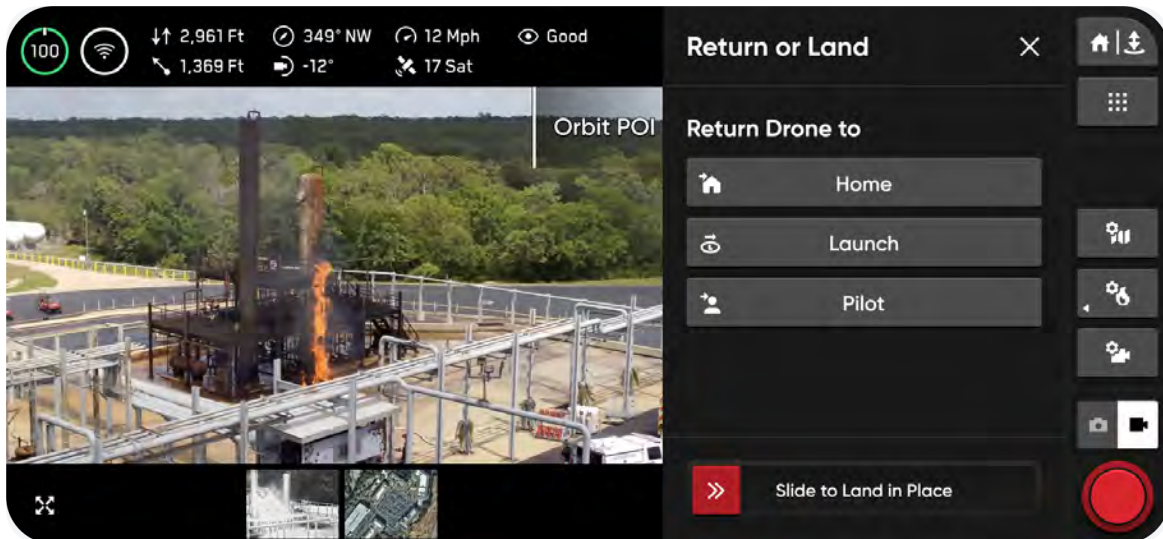

Flight

You have three options when landing in place:

Option 1 - Select and drag the on-screen slider

Landing begins when you lift your finger away from the screen.



Option 2 - Press and hold the Return/Land button on the controller

Landing begins when you see the on-screen check mark.

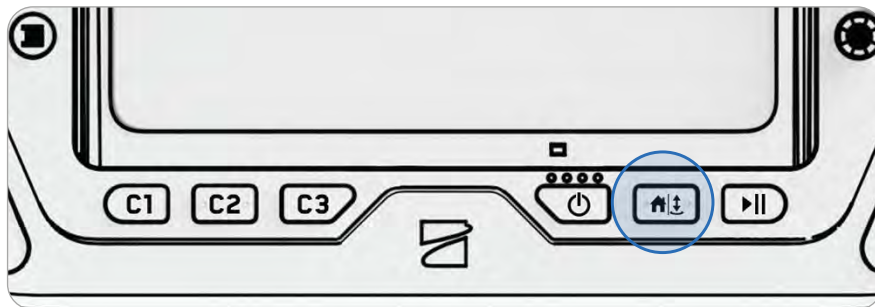

Option 3 - Press and hold the Return/Land button on-screen

Landing begins when you see the on-screen check mark.



WARNING: Obstacle avoidance is disabled when the drone is below 10 ft (3 m) during landing. Exercise extreme care to avoid injury or damage. Do not touch spinning propellers.

Hand Landing

Landing Skydio X10D in your hand is a quick and convenient way to start or end your flight, particularly if you are not in a clear, level area. For your safety, always use caution when hand launching or landing.



WARNING: Do not hand launch or hand land during windy days, when flying at night, or extreme environmental conditions as serious injury and/or damage may occur.

Step 1 - Position Skydio X10D above a clear area so that you can move underneath it

Ensure the drone is facing away from you and extend your arm away from your body.

- The sensor package should face away from your body
- The back of the chassis and the battery are closest to you

Step 2 - Initiate landing

Skydio X10D will descend vertically with full obstacle avoidance until it is 10 ft (3 m) above the ground.

Once your drone is below 10 ft (3 m), the lights on the drone turn yellow to indicate obstacle avoidance is disabled for the remainder of the landing.



WARNING: Do not attempt to grab or catch Skydio X10D without initiating a landing, the motors will continue to spin at full speed and may cause severe injury. Do not attempt to hand land until the lights turn yellow. Attempting to hand land while obstacle avoidance is active will cause it to attempt to avoid your hand and may result in Skydio impacting yourself or another nearby object.

Step 3 - Lightly grab the drone by the battery from underneath as it touches down on your open palm

Once the battery has made contact with your palm, keep your hand steady until the propellers completely stop spinning.

Do not attempt a hand landing if:

- There are high winds present.
- Skydio X10D is not stable in flight for any reason.
- Skydio X10D is performing an emergency landing after an accident or crash.
- You are in an area where you do not have stable footing.
- You are on a moving vehicle or boat.
- Skydio X10D is in Low Light mode, with or without NightSense.

Hot Sensor Package



WARNING: After prolonged use of the flashlight, your sensor package may be hot to the touch and could present a serious burn risk. After landing, wait for your sensor package to cool down before handling.

If you have the VT300-L sensor package and use the flashlight for an extended period of time, the sensor package may be hot to the touch after flight and could present a serious burn risk. If the flashlight is used for the duration of a flight in ambient temperatures of 100°F (38°C), the sensor package can reach temperatures up to 142°C (61°C).

Monitor your controller for any safety notifications and be careful when handling the sensor package after flight.

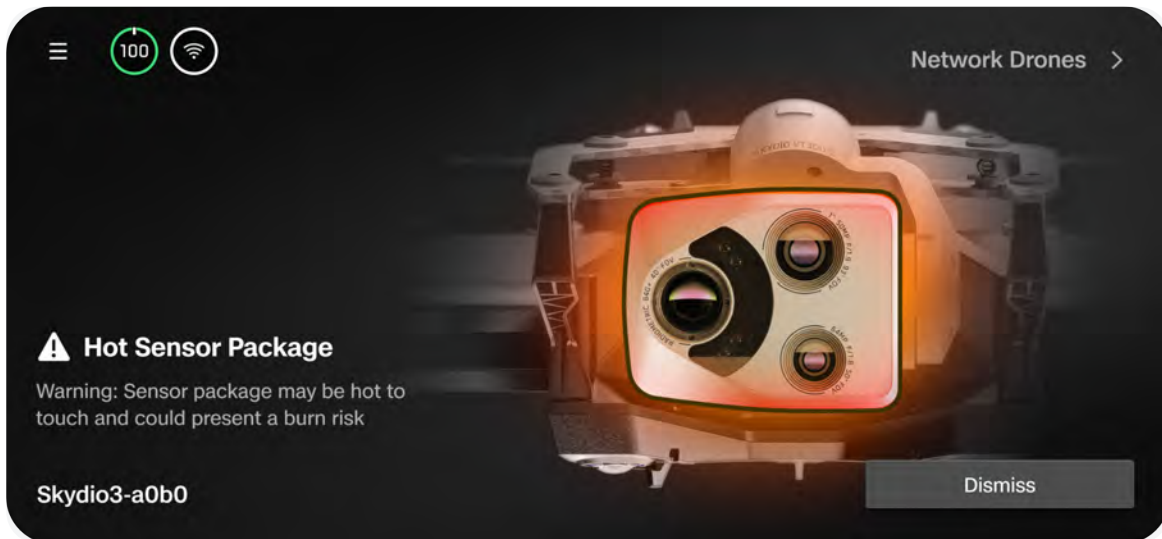



Postflight

Learn how to access media and properly store your drone.

This section covers

Offloading Media

Stowing Skydio X10D

Offloading Media

Select the **Media** menu within **Global Settings** to view photos, videos and scans from your recent flights.

- Select an image or video to view
- Press and hold on a thumbnail to select multiple or delete

If you captured photos using **Interval**, all photos captured will appear as a single stack. Selecting the stack will allow you to scroll through individual images one by one.

Only standard color and thermal JPGs will display in the Media menu. To access your DNG or RJPEG files, you must transfer the files from your drone.



NOTE: *Media is not accessible inflight.*

Transferring Media

Step 1 - Power on Skydio X10D

Step 2 - Connect X10D to your computer

Insert the provided USB-C cable into the USB-C charging port on the back of your drone.

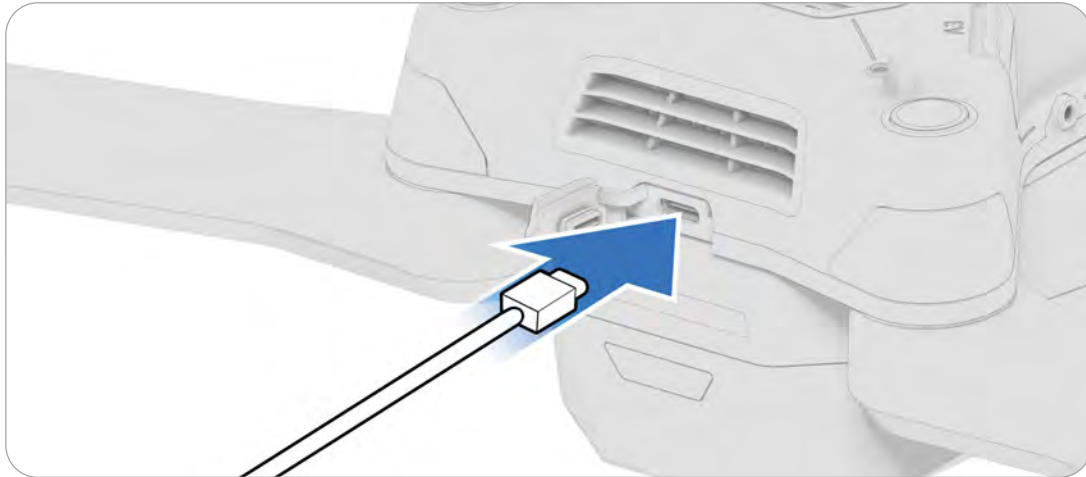

Step 3 - Import your media

If you are using an Apple product, use the Photos app or the Image Capture app to transfer your files.

Stowing Skydio X10D

Step 1 - Wait for postflight tasks to complete

If the battery is low while performing a longer postflight task, such as Onboard Modeling with Map Capture, ensure the drone is plugged into a power source.

- Powering off or removing the battery during postflight tasks will result in loss of data

Step 2 - Power off Skydio X10D and the X10D controller

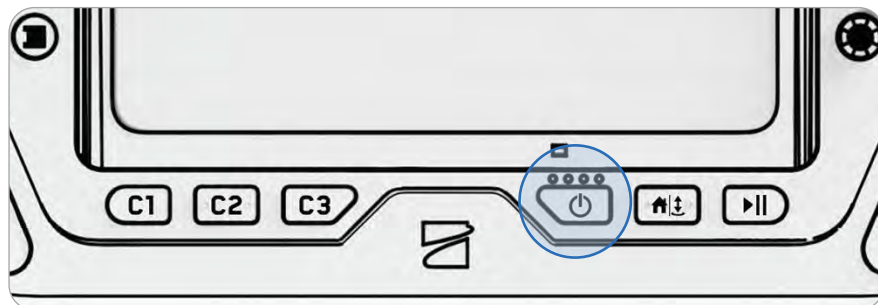
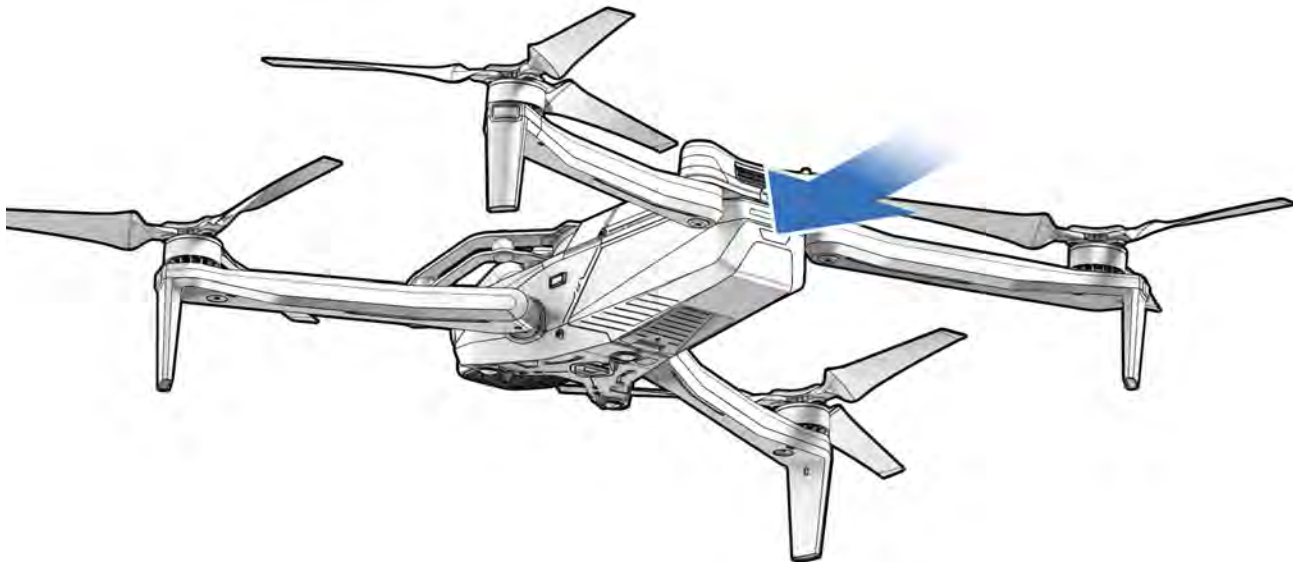

Postflight

Step 2 - Fold in the front arms

Hold the drone with the sensor package facing away from you. Gently pull the arm toward the back of the drone and rotate until it is tucked into place.

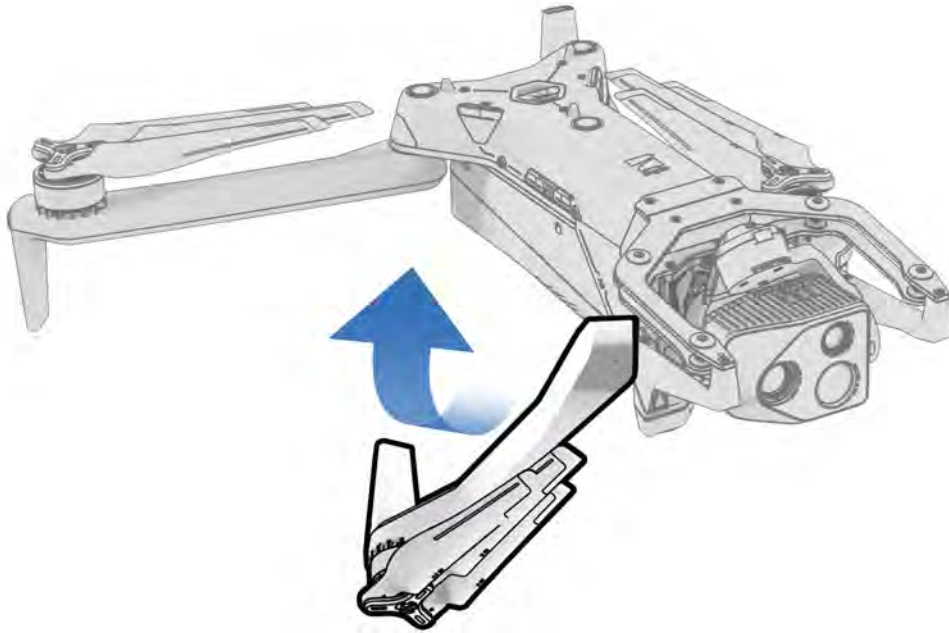

Step 3 - Fold in the rear arms

Push laterally toward the chassis. Gently continue until you meet resistance.

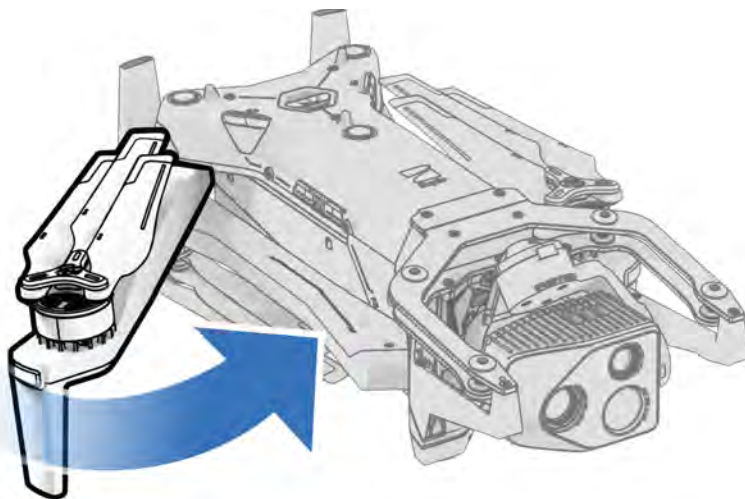

Postflight

Step 4 - Attach the sensor package lock

Hold the sensor package and gently reattach the lock to the top of your drone.

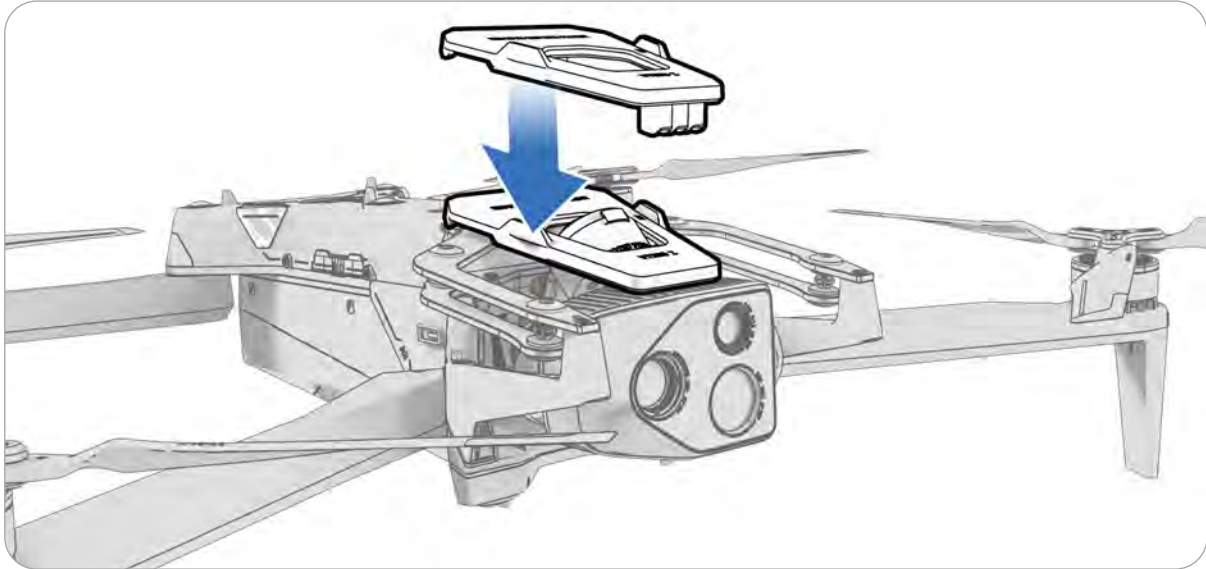

NOTE: Refer to the *Flying in Precipitation* section above for steps on how to properly store your drone after flight in precipitation.

Step 5 - Stow system in the hardshell case for transportation

As demonstrated on page 10.



Contingency Behaviors

Learn about the behaviors during events such as lost connection or low battery. Always monitor Skydio Flight Deck for in-app alerts.

This section covers

Low Battery

Lost Connection

Lost GPS

Reduced Performance State

Controller Overheating

Emergency Landing and Attitude Mode

Flight Termination

Contingency Behaviors



WARNING: While flying, always monitor Skydio Flight Deck for in-app alerts relating to battery levels, signal quality and other inflight notifications.



Scan for more information about Contingency Behaviors.

Low Battery

Skydio X10D will assess the altitude and distance from the Launch or Home Point and alert you when it is time to return and land. It is **strongly recommended you initiate a return or land at this time**. If you selected Auto Return on Low Battery in your return settings, the drone will automatically return at this point.

1. If you continue flying, Skydio X10D will notify you when it has two minutes of flight time left based on its current altitude and the battery indicator will begin a two-minute countdown. **You may choose to continue flying, however, it is strongly recommended that you fly to a safe location and land.**
2. If you ignore the countdown and continue flying, when the two-minute countdown is complete **Skydio will initiate an automatic landing.**



Before flying, configure return settings, such as an automatic return on low battery, in the Return menu (**Global Settings > Return**).



WARNING: You may only choose to cancel an automated landing at your own sole risk—you are responsible for the potential loss of the drone and/or serious bodily harm and property damage.

Lost Connection



WARNING: Before flying, ensure you have set your Lost Connection Return Behaviors. This is a critical step that ensures your drone returns safely and lands in an accessible location.

If connection is lost, Skydio X10D will default to the **Lost Connection** settings. Select between **Return** (default) and **Hover** upon lost connection.

Return (default)

Wait Before Return - set the amount of time you want Skydio X10D to wait before it initiates a return flight, allowing time to reconnect

Land After Return - when enabled, your drone will return, hover for a specified amount of time, then land.

Wait Before Land - the amount of time between 0 to 300 seconds (default is 240 seconds) that you want your drone to wait above the landing location before landing. This setting is only enabled when Land After Return is toggled on.

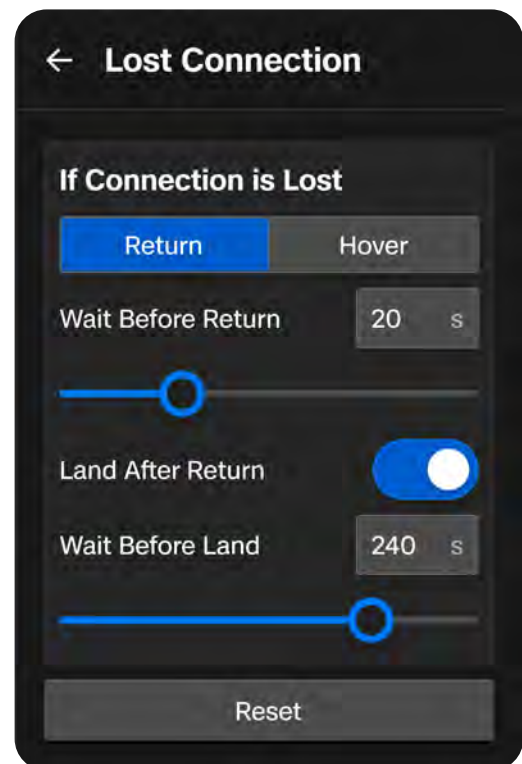

Hover

Land After Hover - when enabled, Skydio X10D will hover for a specified amount of time, then use visual navigation to find a safe area to land.

Wait Before Land - the amount of time between 0 to 300 seconds (default is 240 seconds) that you want your drone to wait before landing. This setting is only enabled when Land After Hover is toggled on.

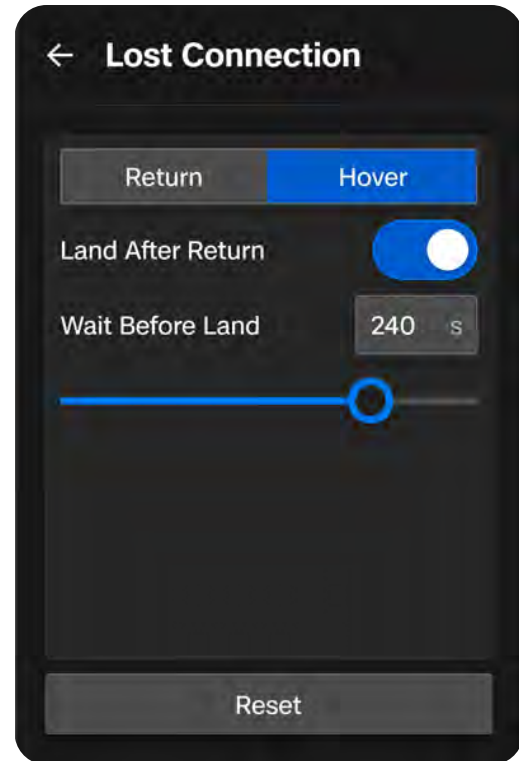

Skydio X10D will continue hovering as it tries to regain connection. If it fails to reconnect and reaches low battery:

- If you have an automatic return set, your drone will return to either the Launch Point or Home Point (if set)
- If you do not have an automatic return set, your drone will use visual navigation to find a safe area to land
- If you do not have strong VIO (e.g. you are flying in Low Light mode without NightSense), your drone will be unable to use visual navigation and will descend vertically and land

Lost GPS

If Skydio X10D loses GPS signal, the drone will continue flying using the vision system. Actions that require GPS will be disabled.

If visual navigation (VIO) is also unavailable, the drone will enter Attitude Mode, a mode of flying that relies on the drone barometer to maintain altitude. By default, if there are no joystick inputs for 5 seconds, the drone will begin emergency landing.

Reduced Performance State due to Battery Capability Limitation

At times of reduced battery performance, the drone will reduce its top speed and acceleration in order to enhance safety:

- Max ascent speed: 2 m/s
- Max ground speed: 12 m/s

Scenarios where the drone will have reduced battery performance include extreme cold, extremely low battery level, overheating, and cell imbalance.

 **Reduced Performance**
The drone speed is reduced due to cold battery.

Controller Overheating

If the Skydio X10D Controller reaches critical temperatures and overheats in flight, it will shut down and lose connection to the drone, triggering the X10D Lost Connection behavior.



To mitigate overheating and reduce the risk of lost connection during flight, the controller will issue two alerts and provide guidance to the operator.

Alert	Operator Action
Controller is Heating Up	Take mitigation actions: <ul style="list-style-type: none">• Move the controller screen out of direct sunlight• Move to a shaded or cooler area if possible• Continue flight - this alert is cancellable
Controller Too Hot to Operate	Take immediate action to land: <ul style="list-style-type: none">• Launch will be prevented• If the drone is in flight the signal between the controller and the X10D will be lost and your drone will default to the operator-defined lost connection settings• This alert is non-cancellable

Emergency Landing and Attitude Mode

If both GPS and the vision navigation system (VIO) become unreliable, Skydio X10D will enter Attitude Mode.



NOTE: Monitor your GPS and VIO health in the telemetry bar. If VIO and GPS both drop below 2 bars of health, your drone will enter Attitude Mode.

In this mode, the drone will use internal barometer readings to maintain altitude when the throttle joystick is centered.

The drone will drift, in which case you will need to adjust roll and pitch movements to maintain the drone's position. The drone will not automatically hold position or automatically brake when the joysticks are centered.



CAUTION: Obstacle Avoidance is not available in attitude mode.

Contingency Behaviors

If the drone regains GPS and/or VIO while in Attitude Mode, it will switch out of Attitude Mode and use whichever navigation system is strongest.

- To have the best chance of recovering VIO, descend below approximately 60 feet above the ground and fly within sight of visual features.
- When GPS becomes available again, a prompt will be displayed. Fly the drone horizontally (either left and right, or back and forth) to regain GPS heading and resume GPS navigation.

Navigate to **Global Settings > Flight Controls > Landing** to configure landing behavior while in attitude mode.

Auto Land in Attitude

Toggled On (default) - After 5 seconds of inactivity in Attitude Mode (i.e. the joysticks are centered and not touched), Skydio X10D will automatically initiate an emergency landing.

Toggled Off - The drone will remain in attitude mode indefinitely under user control while no navigation sources are healthy.

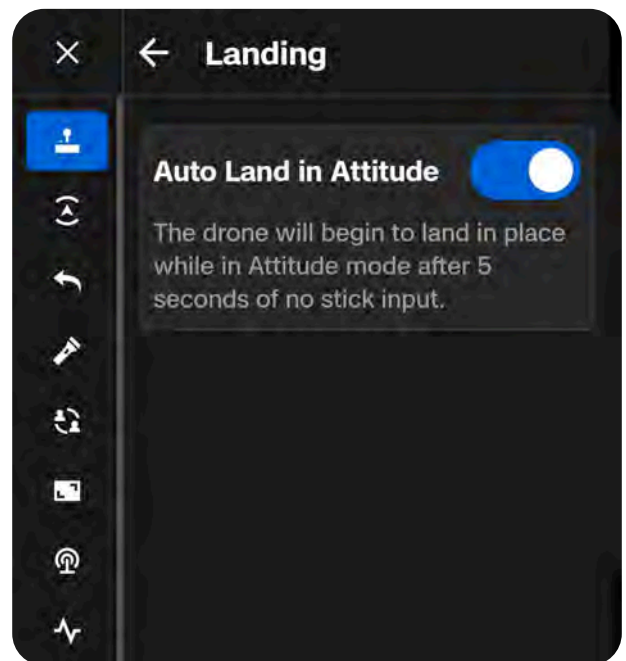

After 5 seconds of inactivity in Attitude Mode (i.e. the joysticks are centered and not touched in a neutral position and not engaged), Skydio X10D will automatically initiate an emergency landing and descend autonomously. An alert notification will display that Skydio X10D is initiating an emergency landing.

If you input any joystick command while the drone is emergency landing, it will stop descending landing and you can continue to fly in Attitude Mode.

Low Battery in Attitude Mode

The drone will not return or land automatically at low battery while flying in Attitude Mode. It is your responsibility to monitor battery level and manually fly the drone to a safe landing location and land the drone when the battery is low. When the battery is low and the throttle stick is centered, the drone will descend to remind you that it is time to land.

Lost Connection in Attitude Mode

If you lose connection with the drone while flying in attitude mode, the drone will descend and emergency land in place.

Landing in Attitude Mode

To land the drone in attitude mode, you can press or hold the Land button to autonomously descend and touch down, or you can manually descend and touch down. The drone will automatically disarm and spin down the propellers after a few seconds when it detects that the drone is safely on the ground and the throttle joystick is held in a full down position.

Flight Termination



WARNING: Terminating a flight will cause your drone to crash. Damage resulting from Flight Termination is not covered under warranty and may result in injury or damage. Use only in extreme situations.

In the event of an extreme emergency, you have the option to immediately terminate your flight. **Simultaneously press and hold the C3 button and Launch/Return/Land button for three seconds** while in flight to immediately stop the motors.

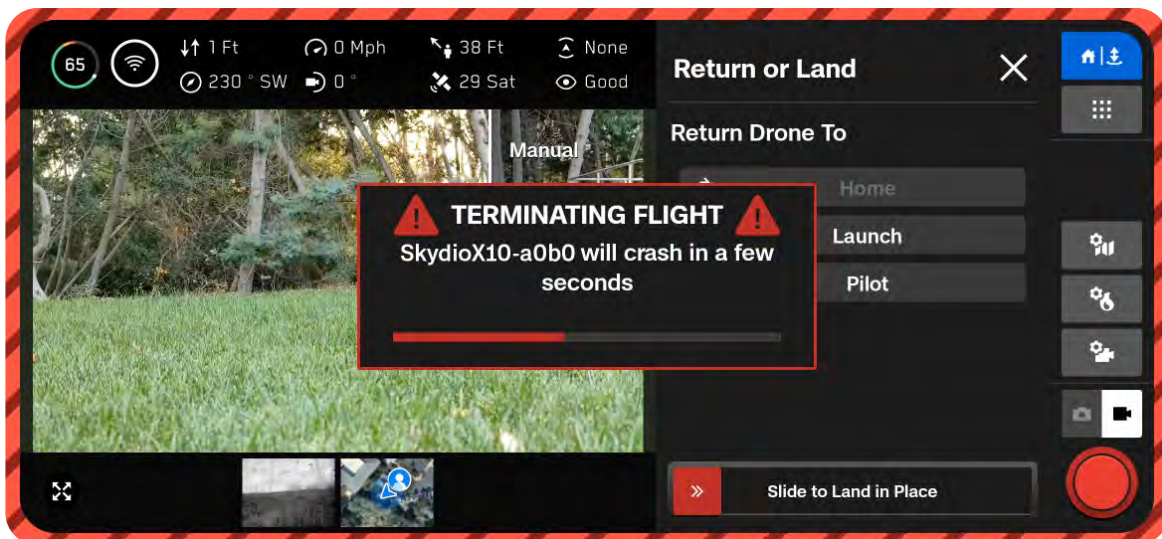



Maintenance

Learn how to replace your propellers and best practices for battery and equipment storage.

This section covers

Replacing Propellers

Cleaning Your System

System Lifespan

Battery Care

Maintenance Schedule

Replacing Propellers

For optimal performance, Skydio recommends replacing your propellers **after 250 hours of flight time** or whenever you notice any damage.



WARNING: Propellers with hairline cracks or large breaks, chops, or bends should be replaced immediately. Do **NOT** fly Skydio X10D with propellers that are not in good condition as serious bodily harm or injury may occur.

Step 1 - Remove old or damaged propeller set

Hold onto the motor with one hand and take the propeller hub in the other. Press down on the propeller hub and twist to release.

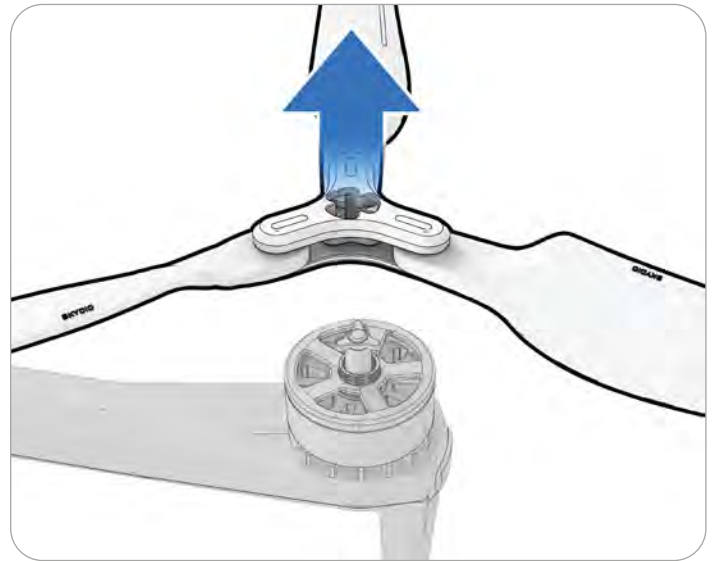
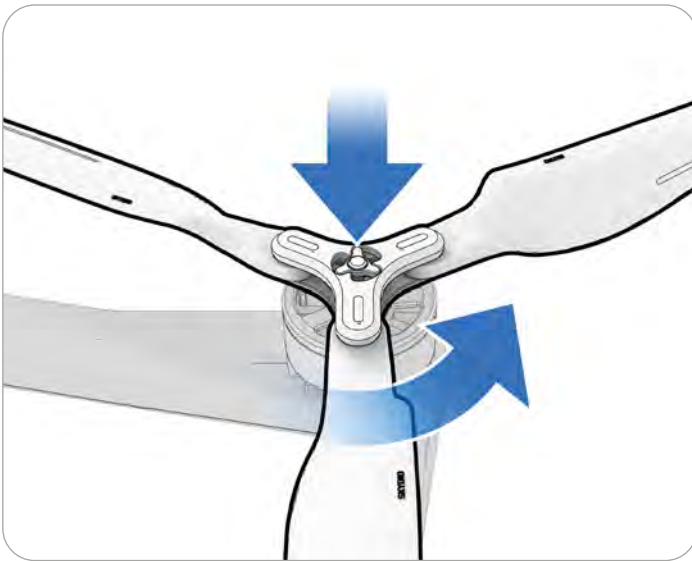

NOTE: You will need to twist either clockwise or counterclockwise depending on the motor.

Maintenance

Step 2 - Identify the propeller set that matches the motor

Match the replacement set of propellers to the color on the motor.

Step 3 - Inspect for any debris

Inspect the motor to ensure there is no dirt or debris.

Step 4 - Install new propeller set

Hold onto the motor with one hand and take the propeller hub in the other. Flip the propeller hub so the opening on the hub aligns with the the motor. Press down and twist to lock in place.

Be gentle and do not force the fitment. If the propeller set does not fit on the motor it might be the incorrect set or side.

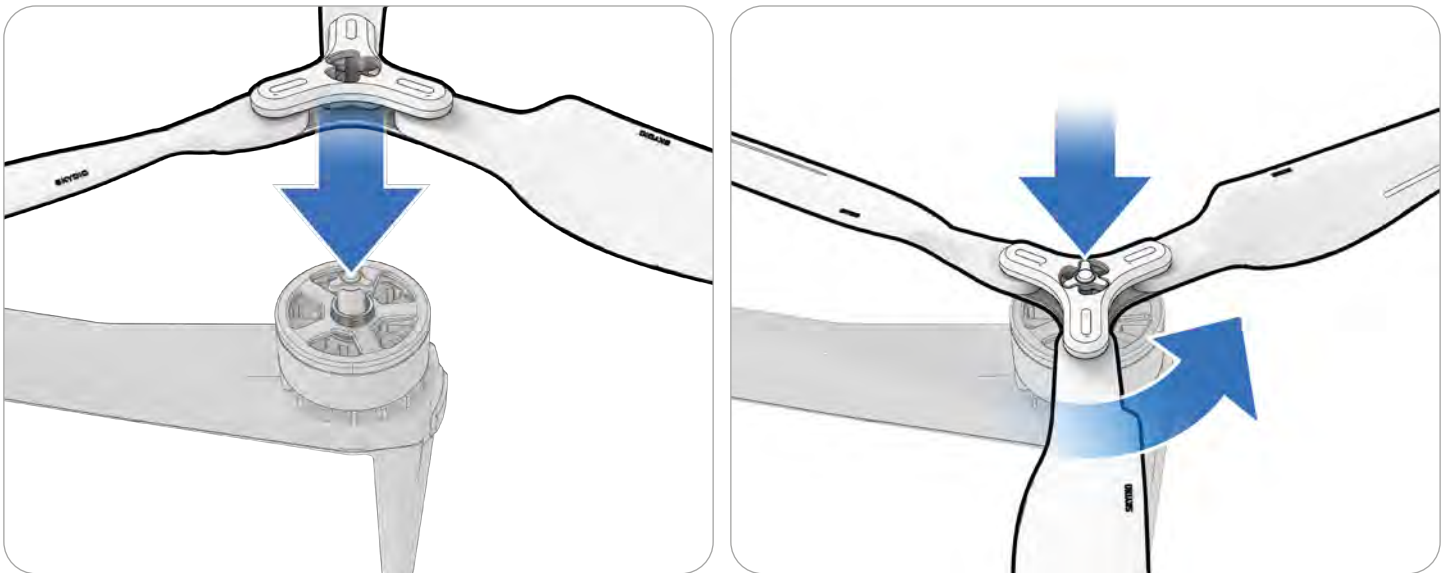

NOTE: You will need to twist either clockwise or counterclockwise depending on the motor.



TIP: The total number of flight hours for your drone is tracked in Skydio Cloud. Consider replacing all propellers at the same time for ease of tracking total propeller flight time.

Cleaning Your System

It is recommended to wipe down your drone after flights in environments with significant dust or debris.



WARNING: Do not submerge your drone or batteries or place them under running water. Water volumes from flight in precipitation are much lower than those from a faucet or hose. Water may get into areas where the drone is not designed to withstand and you may compromise the sensors.

- Wipe down your drone with a dry or water-damp microfiber cleaning cloth.
- Only use lens cleaner on cameras.
- Do not submerge your drone or batteries.
- Do not place your drone or batteries under running water.
- Use a compressed air canister to remove any debris in hard to reach areas.
- If needed, mild soap and water may be used to remove heavier dirt or debris. Avoid getting any soap near ingress areas on the drone.
- Keep all the drain holes on the drone and battery clear. If any debris is blocking a drain hole (e.g., mud), use compressed air or gently scrape with a toothpick to remove.

Storage

- Do not store Skydio X10D while wet. After flying in precipitation, allow the drone to air dry in a dry, temperature-controlled environment before stowing. Visit the **Flying in Precipitation** section of this manual for more information.
- Store batteries at room temperature 71°F - 82°F (22°C - 28°C) for optimal performance and longevity.
- Store batteries in a cool, dry area with less than 75% relative humidity. Do not store your batteries in extreme environmental conditions.
- Batteries in an idle state (14 days of idle time with no flights) will start to self-discharge in an effort to retain capacity. This may take several days to complete and it is normal for the battery to be slightly warm during this discharge process.

Maintenance Schedule

To optimize the performance of your Skydio X10D it's important to keep your drone updated, inspect your equipment, store your equipment properly, and occasionally replace your propellers and batteries.

Action	Interval
Update system	When an update is available (per your organization's guidelines).
Clean drone navigation cameras	Before each operational session, and after sessions in dust or precipitation. If flying in areas with high amounts of dust or debris, you may be prompted to clean your camera lenses before each flight.
Replace propellers	Per 250 hours of flight time
Replace battery	After 300 battery cycles <ul style="list-style-type: none">• A battery cycle is the depletion of at least 80% of the charge.• An undamaged and properly stored battery can be safely used beyond 300 cycles.

Scan the QR code for the complete Skydio X10D Maintenance Manual





Specifications

This section covers

Skydio X10D

Skydio X10D Controller

Sensor Packages

Navigation Camera System

Flight Battery

System Security

Skydio X10D Dual Charger and Power Supplies

Specifications

X10D Drone

Dimensions fully deployed	31.1 x 25.6 x 5.7 in / 79 x 65 x 14.5 cm
Dimensions (folded, no battery)	13.8 x 6.5 x 4.7 in / 35 x 16.5 x 11.9 cm
Weight (incl. batteries)	4.72 lb / 2.14 kg
Max Launch Weight	5.49 lb / 2.49 kg
Operation Frequency	MicroHard 1790-1850 MHz 2040-2110 MHz 2200-2300 MHz 2300-2390 MHz 2400-2500 MHz
Transmitter Power (EIRP)	38 dBm
Hovering Accuracy (windless or breezy)	VIO: +/- 10 cm GNSS: +/- 1 m
Max Angular Velocity	Yaw: 100° /s Roll and Pitch: 225° /s
Max Tilt Angle	40°
Max Ascent Speed	13.4 mph / 22 km/h
Max Descent Speed	9 mph / 14.5 km/h
Max Non-Vertical Descent Speed	13.4 mph / 21.5 km/h
Max Horizontal Speed (at sea level)	45 mph / 72 km/h
Max Horizontal Speed with Obstacle Avoidance	36 mph / 58 km/h
Max Service Ceiling Above Sea Level	15,000 ft / 4572 m density altitude
Max Gust Handling	28 mph / 45 km/h
Max Hover Time	35 minutes
Max Flight Time	40 minutes
Processors	NVIDIA Jetson Orin SoC Qualcomm QRB5165 SoC
Ingress Protection Rating	IP55
GNSS	GPS + Galileo + GLONASS + BeiDou
Operational Temperature Range	-4° to 113°F / -20° to +45°C
Obstacle Avoidance Coverage	True 360°

Specifications

X10D Controller

Dimensions closed	10 x 5 x 3 in / 25.4 x 12.7 x 7.6 cm
Dimensions open	10 x 9 x 3 in / 25.4 x 22.8 x 7.6 cm
Dimensions screen	6.6 in / 16.7 cm
Screen	Dynamic AMOLED touchscreen 120 Hz Adaptive Refresh Rate Resolution: 2340 x 1080 pixels Brightness: 1750 nits (outdoor peak) 392 ppi
Weight	2.5 lb / 1135 g
Operation Frequency	Multiband
Max Range	up to 10 km
Transmitter Power (EIRP)	38 dBm
Ingress Protection Rating	IP54
Operating time	5 hours
Battery	9600 mAh
GNSS	GPS + Galileo + GLONASS + BeiDou
Operational Temperature Range	-4° to 113°F / -20° to +45°C
Wired outputs	HDMI & USB-C
Security	NDA compliant AES-256 encrypted data link Encrypted internal disk storage Password protected Root of trust Trusted boot Secure update

Specifications

VT300-Z Sensor Package

Angular Vibration Range	+/-0.01°
User Controllable Range	+/-90° pitch
Mechanical Range	+/-140° pitch, +/-90° yaw, +75° to -230° roll

VT300-L Sensor Package

Angular Vibration Range	+/-0.01°
User Controllable Range	+/-90° pitch
Mechanical Range	+/-140° pitch, +/-90° yaw, +75° to -230° roll
Flashlight Illumination	22 lux at 3 meters

Telephoto Camera (VT300-Z only)

Sensor	1/2" 48MP CMOS
Diagonal Field of View	13°
Focal Length	35 mm (190 mm equivalent)
Aperture	f/2.2
Focus	hybrid PDAF, 5 m to ∞
Exposure Compensation	+/-3
Electronic Shutter Speed	1/30 to 1/8000
ISO Range	100 to 16000
Max Video Resolution	3840 x 2880
Max Photo Size	8000 x 6000

Specifications

Wide Camera (VT300-L only)

Sensor	IMX989 1" 50.3MP CMOS
Diagonal Field of View	93°
Focal Length	8 mm (20 mm equivalent)
Aperture	f/1.95
Focus	100% focus pixel, 1 m to ∞
Exposure Compensation	+/-3
Electronic Shutter Speed	1/30 to 1/8000
ISO Range	100 to 16000
Max Video Resolution	3840 x 2880
Max Photo Size	8192 x 6144

Specifications

Narrow Camera (VT300-Z and VT300-L)

Sensor	1/1.7" 64 MP CMOS
Diagonal Field of View	50°
Focal Length	10 mm (46 mm equivalent)
Aperture	f/1.8
Focus	hybrid PDAF, 1 m to ∞
Exposure Compensation	+/-3
Electronic Shutter Speed	1/30 to 1/8000
ISO Range	100 to 16000
Max Video Resolution	3840 x 2880
Max Photo Size	9248 x 6944

Specifications

Thermal Camera (VT300-Z and VT300-L)

Thermal Imager	Flir Boson+ Uncooled VOx Microbolometer
Diagonal Field of View	41°
Focal Length	13.6 mm (60 mm equivalent)
Aperture	f/1.0
Focus	5 m to ∞
Thermal Sensitivity	<30mK NEDT
Infrared Temperature Measurement Accuracy	Larger of +- 5°C or 5%
Image Processing	Adreno 650 GPU accelerated ISP pipeline
Max Video Resolution	640 x 512
Photo Size	640 x 512
Photo Format	JPEG, RJPEG
Pixel Pitch	12 um
Temperature Measurement Method	Spot Meter, Region of Interest
Temperature Measurement Range	-40° to 150° C (-40° to 350° C low gain)
Palette	White hot Black hot Ironbow Rainbow

Specifications

Vision Systems / Navigation Cameras

Configuration	6x cameras in trinocular configuration top and bottom
Sensor	Samsung 1/2.8" 32 MP color CMOS
Light Sensitivity	Visible Light
Aperture	f/1.8
Diagonal Field of View	200°
Obstacle Sensing Range	20 meters
Environment Coverage	True 360°

Flight Battery

Capacity	8419 mAh
Voltage	18.55 V
Battery Type	Rechargeable Lithium Ion Polymer
Energy	156.17 Wh
Net Weight	1.56 lb +/- 0.003 lb
Operational Temperature Range	-20° to 60°C
Storage Temperature Range	-20° to +45°C (storage less than 3 months)
Charging Temperature Range	5° to 45°C
Chemical System	Lithium Ion Polymer

System Security

Wireless Encryption	Connect SL: AES-256
NDAA Compliance	NDAA Compliant
Root of Trust	HSM protected keys
System Integrity	Secure boot
Secure Update	AES-256 encrypted, signed, & verified
Internal Disk Storage	Encrypted
SD Cards	Unencrypted
Pairing	Secure wired pairing

Specifications

X10D Dual Charger and Power Supplies

Dimensions	180 x 75 x 48 mm
Weight (w/o Battery)	0.73 lb
Charge Time 230 W barrel jack	1 hour (0-100%)
Charge Time 100 W USB-C	1 hour 45 minutes (0-100%)
Weatherproofing	No ingress protection
Power input (100 W USB-C)	5 VDC, 3 A / 20 VDC, 5A (USB PD)
Power input (230 W barrel jack)	20 VDC, 11.5 A



Legal

This section covers

Safety

Battery

Skydio One (1) Year Limited Warranty

Skydio Care

California Prop 65 Warnings

FCC Compliance Statement

FAA Compliance Statement

Legal

Before operating Skydio X10D, review the *Getting Started* information including the *Operator Manual* available at www.skydio.com/manuals. Retain documentation for future reference.

Safety

Review the *Skydio Safety and Operating Guide* available at www.skydio.com/safety.

Battery

Handle the battery with extreme care and refer to the Operator Manual and to the *Skydio Safety and Operating Guide* for additional information.

Danger of explosion if battery is incorrectly replaced. Replace only with the same or equivalent type recommended by the equipment manufacturer. Carefully dispose of batteries according to manufacturer's instructions and to your local environmental laws and guidelines.

Risque d'explosion si la batterie n'est pas correctement remplacée. Remplacer uniquement par un type identique ou équivalent recommandé par le fabricant de l'équipement. Jeter les batteries conformément aux instructions du fabricant et aux lois et directives environnementales locales.

Charging

Do not use the X10D Dual Charger near wet locations. To avoid the risk of electric shock, use only in dry locations. Do not allow anything to rest on the power cord. Do not locate this device where the cord will be abused by persons working on it. Do not overload wall outlets and extension cords as this can result in fire or electric shock.

N'utiliser pas le X10D Dual Charger à proximité d'endroits humides. Pour éviter tout risque de choc électrique, utiliser uniquement dans des endroits secs. Ne laisser rien reposer sur le cordon d'alimentation. Ne placer pas ce moniteur dans un endroit où le cordon pourrait être maltraité par les personnes travaillant dessus. Ne surcharger pas les prises murales et les rallonges car cela pourrait provoquer un incendie ou un choc électrique.

Skydio One (1) Year Limited Warranty

Skydio warrants the included hardware product against defects in materials and workmanship in hardware under normal use in accordance with published guidelines including but not limited to the *Terms of Use*, *Operator Manual* and the *Skydio Safety and Operating Guide* for one year from the date of delivery (the “Limited Warranty”). The Limited Warranty does not warrant against normal wear and tear or damage caused by accident or abuse and is not applicable to any software provided with the hardware product. The Limited Warranty is subject to the full terms and detailed information about how to obtain service available at www.skydio.com/legal/limited-warranty. If you submit a valid claim under this Limited Warranty, Skydio will either repair, replace, or refund your hardware product at its sole discretion. You may be required to furnish proof of purchase details when making a claim under this Limited Warranty.

Skydio Care

Skydio offers Skydio Care as a subscription service at an additional cost that provides protection from collisions, water damage, or lost drones which are not covered under the Limited Warranty. Skydio Care can be purchased as a one (1) year plan co-extensive with the Limited Warranty, or as a three (3) year plan, which includes a two (2) year extension to the one (1) year term of the Limited Warranty. Skydio Care is subject to the full terms and detailed information about how to obtain service available at <https://www.skydio.com/legal/skydio-care-terms-of-service>. If you submit a valid claim under Skydio Care, you may be eligible to purchase discounted drone replacements for otherwise uncovered damage or losses. The Skydio Care benefits are in addition to the rights provided under the Limited Warranty.

California Prop 65 Warnings

Skydio X10D uses lithium-ion batteries. Exposure to lithium-ion, containing cobalt lithium nickel oxide, and nickel, is known to the State of California to cause cancer and birth defects, or other reproductive harm. For more information visit:

www.P65Warnings.ca.gov.

Skydio X10D Controller contains chemicals including cadmium, which is known to the State of California to cause cancer and birth defects, or other reproductive harm. For more information visit: www.P65Warnings.ca.gov.

Skydio X10D Dual Charger contains chemicals including BPA and nickel, which are known to the State of California to cause cancer and birth defects, or other reproductive harm. For more information visit: www.P65Warnings.ca.gov.

FCC Compliance Statement

These devices comply with Part 15 of the FCC Rules and with ISED Canada license-exempt RSS standard(s). Operation is subject to the following two conditions: (1) these devices may not cause harmful interference, and (2) these devices must accept any interference received, including interference that may cause undesired operation.

Ces appareils sont conformes aux normes RSS exemptes de licence d'ISDE Canada. Leur fonctionnement est soumis aux deux conditions suivantes: (1) ces appareils ne doivent pas causer d'interférences nuisibles, et (2) ces appareils doivent accepter toutes interférences reçues, y compris les interférences susceptibles d'entraîner un fonctionnement indésirable.

Changes or modifications not expressly approved by Skydio could void the user's authority to operate these devices.

These devices have been tested and found to comply with the limits for a Class A digital device, pursuant to part 15 of the FCC Rules. These limits are designed to provide reasonable protection against harmful interference when these devices are operated in a commercial environment. These devices generate, use, and can radiate radio frequency energy and, if not installed and used in accordance with the Operator Manual and Safety and Operating Guide, may cause harmful interference to radio communications. Operation of these devices in a residential area is likely to cause harmful interference in which case the user will be required to correct the interference at his own expense.

This Class A digital apparatus complies with Canadian ICES-003.

Cet appareil numérique de classe A est conforme à la norme Canadienne NMB-003.

Legal

FAA Compliance Statement

Unless specifically exempt, this product complies with 14 CFR Part 89 regulations on Remote Identification per ASTM F3411-22a-RID-B and ASTM F3586-22.

Software License

The *Skydio Software End-User License Agreement* available at www.skydio.com/legal/eula governs the use of any Skydio software that is pre-installed, downloaded, installed, or otherwise provided in connection with any included hardware.

Additional Resources

For all the latest information about Skydio and our products visit: www.skydio.com.

For Skydio legal information and product terms of use visit: www.skydio.com/legal.

Skydio products are protected by patents and trademarks, registered in the United States and other countries. For Skydio intellectual property information visit: www.skydio.com/legal/ip.

© 2024 Skydio, Inc. All rights reserved. Skydio and the Skydio logo are trademarks of Skydio, Inc., registered in the United States and other countries.



If you need assistance, please reach out to: FedSupport@skydio.us

