

# Skydio X10D ATO

## Operator Manual

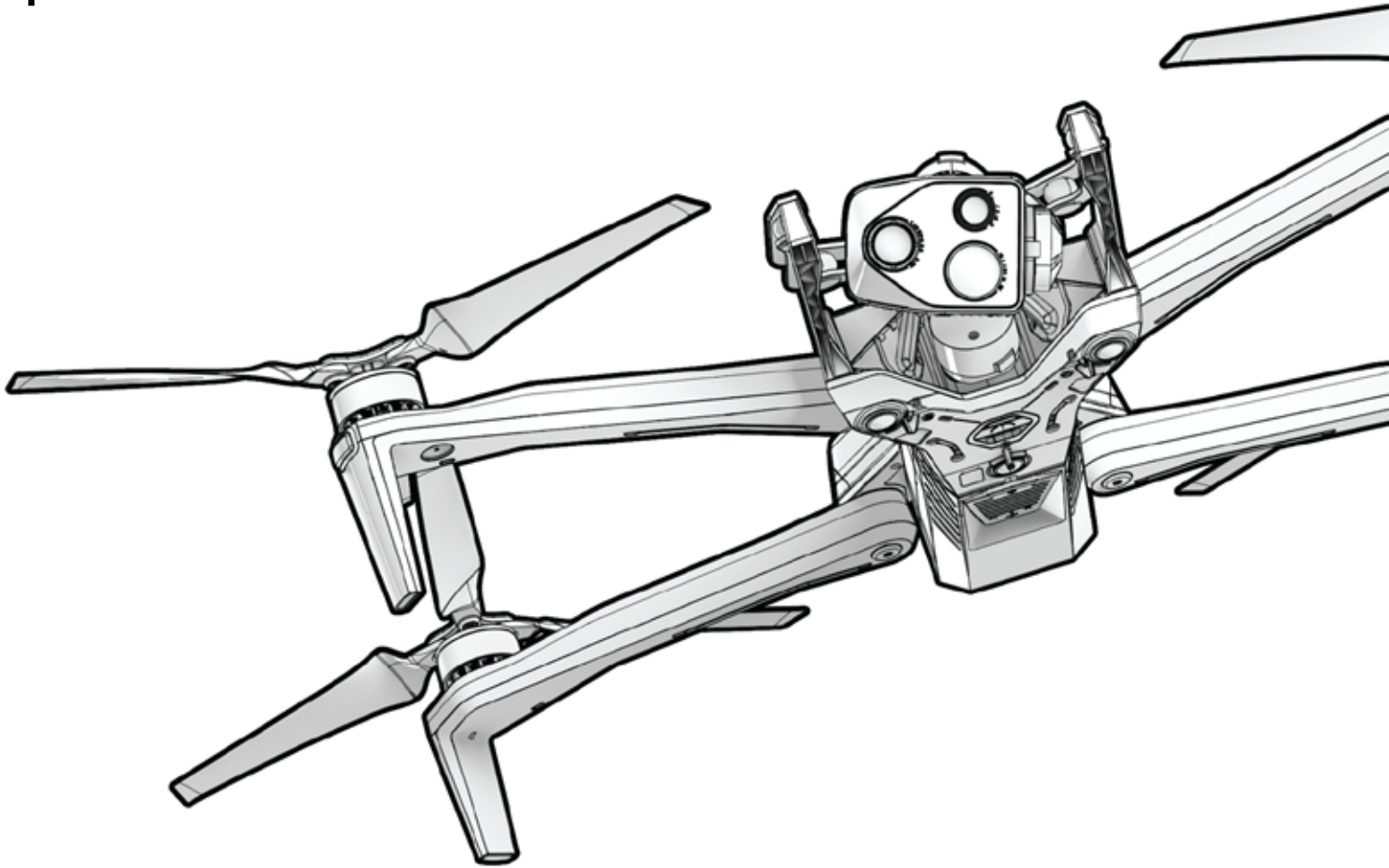

Vehicle version: **Cayley 43.147.56**

Controller version: **44.79.19**

Document version: **14.0**

Updated: **2 April 2026**



**WARNING:** Please read all documentation provided with your Skydio X10D, including but not limited to the X10D Safety Guidelines in the Safety and Operating Guide: [www.skydio.com/safety](http://www.skydio.com/safety). Failure to follow any instructions or recommendations in our documentation may void the Skydio Limited Warranty.

# Change Log

Revision	Date	Page	Description
1.0	25 March 2024	<b>All</b>	Initial software release vehicle 31.6.121 / controller 31.6.88
2.0	11 June 2024	<b>Cover</b>	Software release vehicle 34.1.114 / controller 34.1.79
2.0	11 June 2024	<a href="#">51</a>	Low Light selection replaces the GPS Only toggle
2.0	11 June 2024	<a href="#">109</a>	NightSense information added
2.0	11 June 2024	<a href="#">47</a>	Action wheel information added
2.0	11 June 2024	<a href="#">55</a>	Deleted vision return as a selection option
3.0	27 June 2024	<b>Cover</b>	Software release vehicle 34.1.125 / controller 34.1.81
4.0	14 August 2024	<b>Cover</b>	Bug fix software release vehicle 34.1.140 / controller 34.1.86
5.0	22 October 2024	<b>Cover</b>	Software release vehicle 37.1.182 / controller 37.1.159
5.0	22 October 2024	<b>c</b>	Updated QR codes
5.0	22 October 2024	<a href="#">31</a>	WiFi Enabled controller information
5.0	22 October 2024	<a href="#">63</a>	Added Radio Frequency to telemetry bar
5.1	02 January 2025	<a href="#">121</a>	Added Low Light launch height
6.0	19 February 2025	<b>Cover</b>	Software release vehicle 37.7.6 / controller 37.7.1
7.0	24 April 2025	<a href="#">35</a>	Gate screen image
7.0	24 April 2025	<a href="#">44</a>	Flight Control Screen image
7.0	24 April 2025	<a href="#">49</a>	Weak GPS Altitude Limits update to 164 ft
7.0	24 April 2025	<a href="#">50</a>	Attitude Mode image and info
7.0	24 April 2025	<a href="#">57</a>	Attitude Mode return
7.0	24 April 2025	<a href="#">61</a>	Gridlines
7.0	24 April 2025	<a href="#">79</a>	Camera shutter capture sound
7.0	24 April 2025	<a href="#">97</a>	Launch clearance / Low launch
7.0	24 April 2025	<a href="#">99</a>	Weak GPS Alt Limit 164 ft (50 m)
7.0	24 April 2025	<a href="#">101</a>	Updated fly screen

7.0	24 April 2025	<a href="#">102</a>	Battery Indicator update
7.0	24 April 2025	<a href="#">103</a>	Navigation indicator update
7.0	24 April 2025	<a href="#">132</a>	Offloading screen captures
7.0	24 April 2025	<a href="#">144</a>	Return in Attitude Mode
7.0	24 April 2025	<a href="#">151</a>	Export logs
8.0	29 May 2025	<a href="#">Cover</a>	Software release vehicle 39.237 / controller 39.186
8.0	29 May 2025	<a href="#">58</a>	Updated light information
8.0	29 May 2025	<a href="#">161</a>	Added battery specs
8.1	25 June 2025	<a href="#">Cover</a>	Software release for controller 39.187.1
9.0	27 August 2025	<a href="#">Cover</a>	Software release vehicle 39.301 / controller 39.257
9.0	27 August 2025	<a href="#">28-29</a>	Software update instructions updated
9.0	27 August 2025	<a href="#">36</a>	Updated button mapping for screenshots
9.0	27 August 2025	<a href="#">37</a>	Updated image
9.0	27 August 2025	<a href="#">49</a>	Included Range Limits Geofence
9.0	27 August 2025	<a href="#">49</a>	Included Slow Mode
9.0	27 August 2025	<a href="#">55</a>	ADS-B
9.0	27 August 2025	<a href="#">57</a>	Added attitude mode image
9.0	27 August 2025	<a href="#">59</a>	Updated ATAK images
9.0	27 August 2025	<a href="#">61</a>	Added gridline images
9.0	27 August 2025	<a href="#">62</a>	Additional telemetry items
9.0	27 August 2025	<a href="#">67</a>	Addition of the Sound Menu
9.0	27 August 2025	<a href="#">106</a>	Updated skills info and images
10.0	07 October 2025	<a href="#">Cover</a>	Software release vehicle 39.327 / controller 39.264
11.0	08-December-2025	<a href="#">Cover</a>	Software release vehicle 39.328.17 / controller 39.328.4
11.0	08-December-2025	<a href="#">140-142</a>	Additional Low Battery information added
12.0	03-February-2026	<a href="#">31</a>	Map menu update
12.0	03-February-2026	<a href="#">57</a>	Lighting menu update
12.0	03-February-2026	<a href="#">58</a>	Sharing menu update
12.0	03-February-2026	<a href="#">66</a>	Lighting menu update
13.0	6-March-2026	<a href="#">Cover</a>	Controller software release 44.6.49



# Additional Resources

The Skydio X10D is the offline variant of the X10 and shares hardware, sensor packages, attachments, and controller running Skydio Flight Deck software. However, there are features that make the X10D unique. X10D does not require network connectivity, ensuring that your data is always secure. The X10D multiband radio allows for frequency diversity and longer range in the lower frequency bands. Skydio X10D is an open, modular platform ready for additional payload options. RAS-A compliance and the MAVLINK protocol includes manual vehicle control, autonomous missions, camera and payload control, vehicle-specific skills, radio link and pairing configuration, integration with third-party radios, controllers, and flight application software. The instructions for flying your Skydio X10D are the same as the X10 unless identified in the X10D section.

Scan the QR codes to view more information about flying with Skydio X10D.



**Getting Started with  
Skydio X10D**



**Flying with  
Skydio X10**



**Skydio X10D  
Resources**



**Skydio X10D  
Maintenance**



**Skydio X10D Safety  
and Operating Guide**



**Skydio Legal**

For legal, warranty and intellectual property information, visit: [www.skydio.com/legal](http://www.skydio.com/legal)

If you need assistance, please reach out to [FedSupport@skydio.us](mailto:FedSupport@skydio.us)

# Table of Contents

<b>Flying Safely</b> .....	<b>1</b>
Safety Guidelines .....	1
Warnings .....	2
Regulations .....	7
<b>Getting Started</b> .....	<b>8</b>
Skydio X10D Starter Kit .....	9
Skydio X10D Hardware .....	11
Skydio X10D Controller Hardware .....	13
Skydio X10D Autonomy Features .....	14
Charging .....	15
Finding Drone Name and Battery Serial Number .....	21
<b>Preflight</b> .....	<b>22</b>
Skydio X10D Setup .....	23
Updating the Skydio X10D System .....	28
Encryption .....	30
Importing Maps .....	31
Battery Warming in Cold Environments .....	32
<b>Skydio Flight Deck</b> .....	<b>34</b>
Gate Screen .....	35
Global Settings .....	36
Media .....	37
Information .....	38
Maps .....	40
Waypoint Mission .....	41
Flight Controls .....	44
Sensitivity .....	45
Controls .....	46
Action Wheel .....	47
Limits .....	49
Sensing .....	50
Return .....	52
ADS-B .....	54
Lost Connection .....	55
Lighting .....	57
Sharing .....	58
Radio .....	59
Display .....	60
Telemetry .....	61
Sound .....	66
System Status .....	67
Quick Actions .....	68
Inflight Map .....	71

# Table of Contents

<b>Camera Settings</b> .....	<b>72</b>
Video Settings .....	80
Thermal Camera .....	83
<b>Flight</b> .....	<b>92</b>
Preflight Inspection .....	93
Pairing Devices .....	95
Launching .....	97
Flight Screen .....	101
Battery Indicator .....	102
Navigation Indicator .....	103
Flight Skills .....	104
Flying at Night .....	107
Flying in Precipitation .....	116
Returning and Landing .....	125
<b>Postflight</b> .....	<b>131</b>
Offloading Media .....	132
Stowing Skydio X10D .....	134
<b>Contingency Behaviors</b> .....	<b>137</b>
Low Battery .....	138
Lost Connection .....	142
Lost GPS and Attitude Mode .....	144
Flight Termination .....	147
Controller Overheating .....	148
<b>Maintenance</b> .....	<b>149</b>
Replacing Propellers .....	150
Cleaning Your System .....	152
Storage & Export Logs .....	153
Maintenance Schedule .....	154
<b>Specifications</b> .....	<b>155</b>
<b>Legal</b> .....	<b>165</b>

# Safety Guidelines



**WARNING:** To avoid injury or damage to your drone, read the Skydio X10D Safety Guidelines in the Safety and Operating Guide.

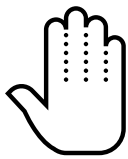

Keep your fingers away from moving propellers at all times.



Use caution around reflective surfaces (e.g., still water or mirrors) and small obstacles (e.g., thin branches, utility lines, or chain link fencing)

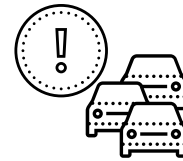

Skydio X10D does not avoid moving objects (e.g., vehicles).



Skydio X10D obstacle avoidance can be impaired when in low light and poor visibility when flying without NightSense. Fly with extreme caution under these conditions.



Before flying over water, ensure your drone has a strong GPS signal. Launch and land over a dry surface.



Skydio X10D is IP55 rated and able to fly in light to moderate precipitation with obstacle avoidance disabled. Skydio X10D Controller is IP54 rated.



Clean all of the cameras before each flight so Skydio X10D can see clearly.

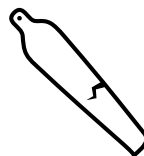

Check your propeller blades for damage before each flight.



Follow all civil aviation authority regulations, as well as all local, state, and federal laws.

## Warnings

- Do not operate directly over people and vehicles without following all required regulations and garnering any required Certificates of Waiver or Authorization (COA).
- Fly with extreme caution and care around moving obstacles including but not limited to other aerial vehicles, cars, and/or animals.
- Skydio obstacle avoidance may be degraded around transparent or reflective surfaces, windows, mirrors, or still water greater than 23 in (58 cm) wide. Fly with caution.
- The pilot in command (PIC) is solely responsible for: a) managing altitude, range, and battery level and b) following all civil aviation authority regulations, as well as all local, state, and federal laws.
- Adhere to all in-app alerts, warnings, and recommendations such as landing in clear and safe areas.
- Propeller blades are sharp—handle with extreme caution and care especially when the propeller blades are spinning as serious injury and/or damage may occur.
- Obstacle avoidance is disabled during launching and landing. Exercise extreme caution and care to avoid injury and/or damage.
- When using the flashlight on the VT300-L sensor package, do not stare directly into the light at any range for any extended period of time.
- Ensure your landing area is flat, stable, and clear of obstacles.
- Skydio should not be used or handled by a person under the age of 16 years.
- Never fly near or interfere with crewed aircraft operations.
- Never fly under the influence of drugs or alcohol.

## Preflight

- Skydio X10D navigates visually using cameras so it is essential to keep all of the cameras clean. Use the included microfiber cleaning cloth (or a similar type of microfiber cloth) to ensure camera lenses are free of dust and dirt before every flight.
- Ensure all propellers are firmly attached and free of nicks, cracks, or other visible damage. Never fly with damaged propellers.
- Keep your fingers away from spinning propellers at all times.
- Ensure all 4 arms are fully deployed prior to initiating flight. Failure to do so may result in unstable flight and/or a loss of control.
- Skydio X10D uses magnets to retain the battery which may attract metallic debris that could interfere with the connection of the battery to the drone.
  - Prior to installing the battery, inspect the battery connection pins and the battery bay to ensure that they are undamaged and free of debris.
  - Verify the battery is fully seated in the drone prior to launching.
- Do not fly with any batteries with enclosures that are cracked, swollen, gouged, dented, or otherwise substantially physically deformed.
- Safely handle and dispose of any batteries in accordance with all local laws and regulations.
- Batteries should not be stored in extreme environmental conditions.
- Ensure the Skydio X10D Controller has adequate battery life remaining to complete your intended flight.
- Ensure you have set your Return and Lost Connection behaviors before flying.
- Remove the sensor package lock before flying.
- Inspect the chassis and entire drone for damage and debris prior to flight.

## Environment

- Skydio X10D is IP55 rated providing protection from limited dust ingress and light to moderate precipitation conditions; it is recommended to not fly in heavy dust conditions or heavy precipitation.
- The Skydio X10D Controller is IP54 rated providing protection from limited dust ingress and light precipitation conditions; it is recommended to not be used in heavy dust conditions or moderate to heavy precipitation.
- Flight in icy conditions is not supported and may result in the loss of your drone.
- Ensure the flight environment has good initial visibility and will have good visibility throughout the duration of the flight.
- Do not hand launch or hand land during windy days, when Low Light flight is enabled, when flying at night, or extreme environmental conditions as serious injury and/or damage may occur.
- Fly cautiously over bodies of water as low relative-altitude flight may degrade or impair autonomous flight performance. Before flying over bodies of water, ensure your drone has a strong GPS signal. Fly at least 10 ft (3 m) above the surface of the water.
  - Failure to acquire strong GPS prior to flight over water may result in erratic flight and/or emergency landing and total loss of the drone.
- Launch and land over dry surfaces. Use extreme caution and care when launching or landing from moving vessels.
- Skydio X10D requires good visibility to retain its obstacle avoidance capabilities. Obstacle avoidance can also be impaired when in low light (without NightSense) and poor visibility. Fly with extreme caution and care under these conditions.
- Skydio does not recommend flying the X10D under the following conditions which can result in serious injury and/or damage including total loss of the drone:
  - Gusts at or above 28 mph (45 km/h)
  - Temperatures less than -4°F (-20°C) or more than 113°F (45°C)
- The Skydio X10D battery features self-warming technology. When flying in temperatures below 32°F (0°C), prewarm batteries before launching. Battery endurance may be degraded when operating near temperature limits below -4°F (-20°C) and above 113°F (45°C).

## Flying Safely

- Your Skydio drone only avoids obstacles that are not in motion.
  - Cars, boats, people, animals, drones, crewed aircraft, or other moving objects may not be avoided.
- In the event that your X10D collides with an object, it will attempt to stabilize and continue flying.
- Keep your fingers away from the propellers anytime they are spinning such as during launch, flight, and landing.
- Skydio X10D cannot see certain visually challenging obstacles. Do not fly around thin branches, telephone or power lines, ropes, netting, wires, chain link fencing, or other objects less than 0.5 inch (1.3 centimeters) in diameter. This type of crash is not covered under the Skydio Limited Warranty.
- Do not intentionally try to crash Skydio X10D.
- The chassis of Skydio X10D may become hot to the touch in high-temperature environments or direct sunlight, even when powered off. The metal frame may also become hot if powered on while on the ground for long periods of time. Handle with extreme caution and care.
- Do not fly over bodies of water if Skydio X10D indicates a GPS quality warning.
- Exercise extreme caution and care when the sun is low on the horizon as it can temporarily blind the Skydio X10D cameras depending on the angle of flight. Your drone may be cautious or jerky when flying directly toward the sun.
- Skydio X10D may provide an indication, such as displaying an alert to land, if it encounters an issue or determines the environment is not safe for flying. Fly to the nearest safe area and land immediately.
- Flying at high altitudes may significantly increase the time required to return and safely land the Skydio X10D. The pilot is solely responsible for managing altitude, range and battery level at all times.
- Be sure to read/watch all flight tutorials and safety-related materials and pay close attention to any in-app messages.
- Keep your hands on the controller joysticks to maintain control throughout flight.

- In preparation for landing, stop active autonomous Flight Skills and fly to a clear and stable area. Avoid areas with people, animals, and moving objects. Try to avoid areas with lots of fine pebbles, sand, rocks, or similar materials.
  - The lights on X10D will turn yellow as the drone descends below 10 ft (3 m) indicating that obstacle avoidance is disabled.
  - **WARNING:** Do not attempt to hand catch Skydio X10D before obstacle avoidance is disabled automatically during landing. Attempting to hand catch Skydio X10D while obstacle avoidance is still active will cause it to attempt to avoid your hand and may result in Skydio X10D impacting yourself or another nearby object, resulting in serious injury and/or damage.
  - While Skydio X10D is landing you may nudge the drone forward, backward, left, or right using the Skydio X10D Controller joysticks.
  - Always monitor Skydio X10D during landing and be prepared to use the nudge feature or cancel the landing if Skydio X10D is landing in an undesirable location. Use extreme caution and care when landing on elevated platforms, such as the roof of a car or truck, as the Skydio X10D may move laterally to avoid the platform before descending to the 10 ft (3 m) threshold.

## Regulations

- You are solely responsible for your Skydio X10D at all times.
- Always follow [FAA](#) and country-specific civil aviation authority regulations, as well as local, state, and federal laws and regulations when operating your Skydio X10D.
- Download the [FAA Drone Safety Guide](#) (if located in the United States).
- Check resources including but not limited to [knowbeforeyoufly.org](#) or apps like [B4UFLY](#) for more information.
- Do not fly in an environment where the use of drones is restricted or not authorized.
- **Maintain visual line of sight at all times**, unless you have received express permission to fly beyond visual line of sight from a civil aviation authority such as the FAA.
- Skydio X10 drones sold in the United States are Remote ID-compliant.



# Getting Started

Welcome to your Skydio X10D! Review the basic hardware and accessories that come with your drone before your first flight.

## **This section covers**

---

Skydio X10D Starter Kit

---

Skydio X10D Hardware

---

Skydio X10D Controller Hardware

---

Skydio Autonomy Features

---

Charging

---

# Skydio X10D Starter Kit

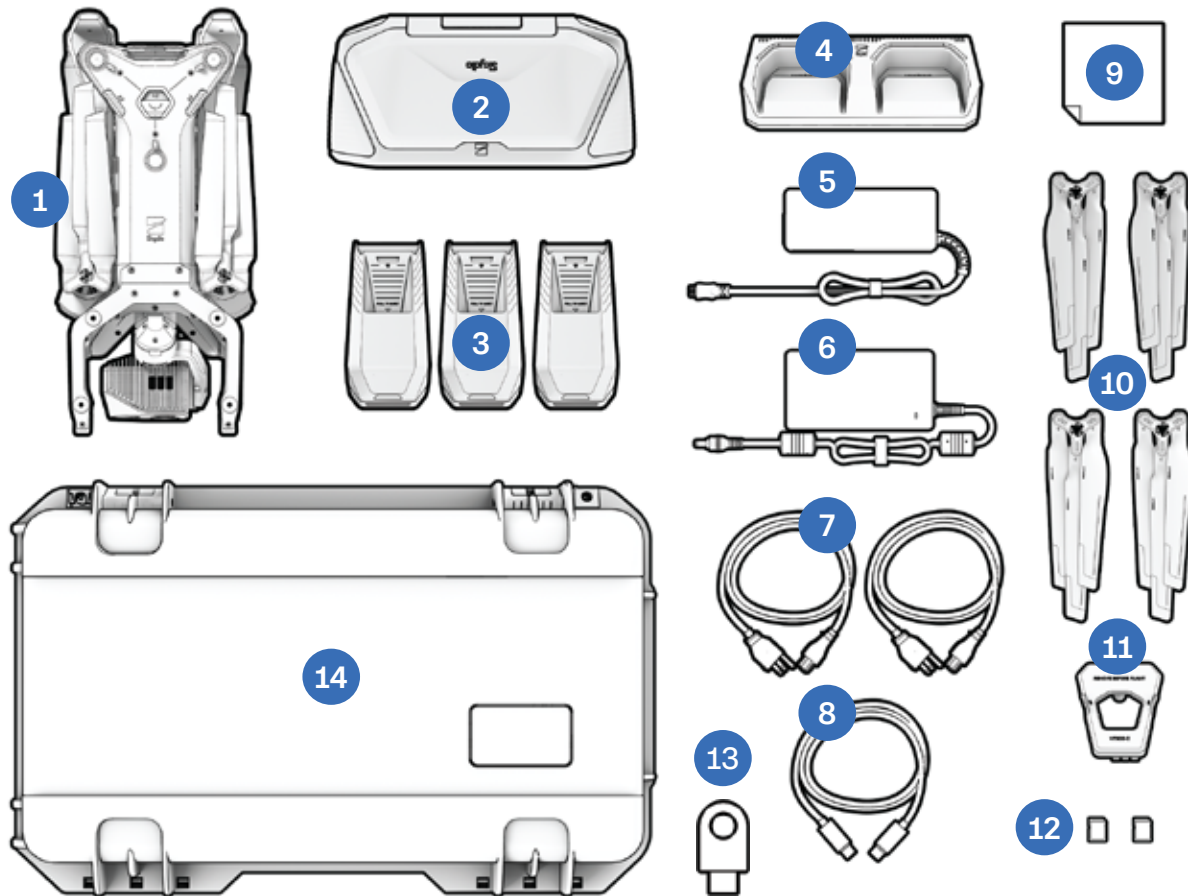

- 1. Skydio X10D vehicle and sensor package
- 2. Skydio X10D Controller
- 3. Batteries (3)
- 4. Skydio X10D Dual Charger
- 5. 100 W power supply (USB-C)
- 6. 230 W power supply (barrel jack)
- 7. Power cables (2)
- 8. USB-C to USB-C pairing cable
- 9. Microfiber cleaning cloth
- 10. Spare propeller sets (4)
- 11. Sensor package lock
- 12. 256 GB microSD cards, pre-installed (2)
- 13. Encryption Key
- 14. Transport Case



*Scan for more information about the kits available for purchase.*

# Skydio X10D Starter Case Layout

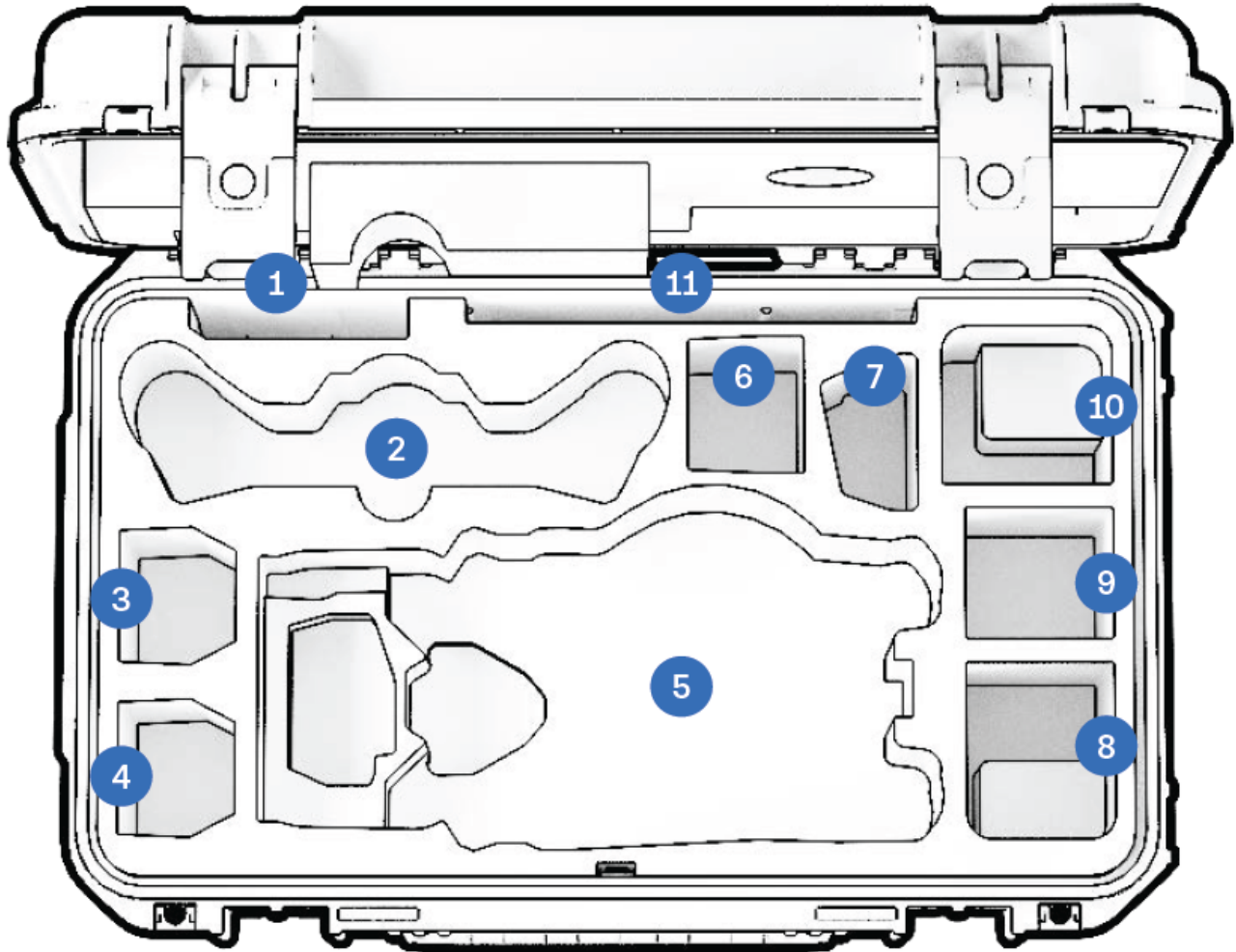

- |  |   |
|--|---|
| <b>1.</b> Propellers                                     | <b>7.</b> X10D Dual Charger   |
| <b>2.</b> X10D Controller                                | <b>8.</b> Flex space: 100 W Power Supply or Attachment                                |
| <b>3.</b> X10D Battery                                   | <b>9.</b> Flex space: Attachment or 100 W Power Supply only (battery not recommended) |
| <b>4.</b> X10D Battery                                   | <b>10.</b> Flex Space: 230 W Power Supply or Attachment                               |
| <b>5.</b> Skydio X10D Drone                              | <b>11.</b> Quick Start Guide and other documents                                      |
| <b>6.</b> Flex space: X10D Battery or 100 W Power Supply |   |

# Skydio X10D Hardware

1. Chassis
2. Arm (4)
3. Sensor package
4. Sensor package frame
5. Log and Media card slots (2)
6. Top navigation cameras (3)
7. Top attachment bay (A2)
8. Side attachment bay (A3, A4)
9. Bottom navigation cameras (3)
10. Bottom attachment bay (A1)
11. Time of flight sensor
12. Parachute strap location (optional attachment)

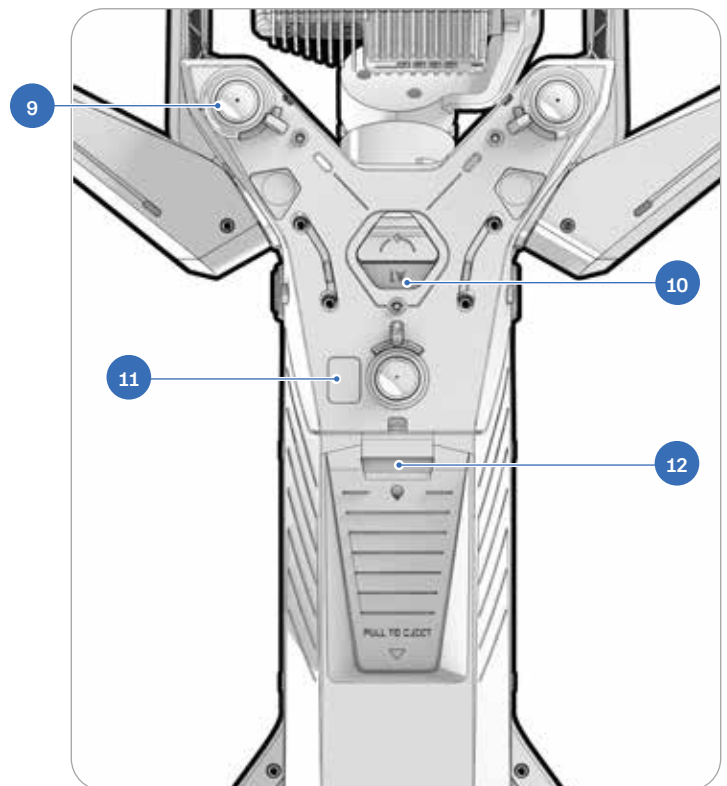
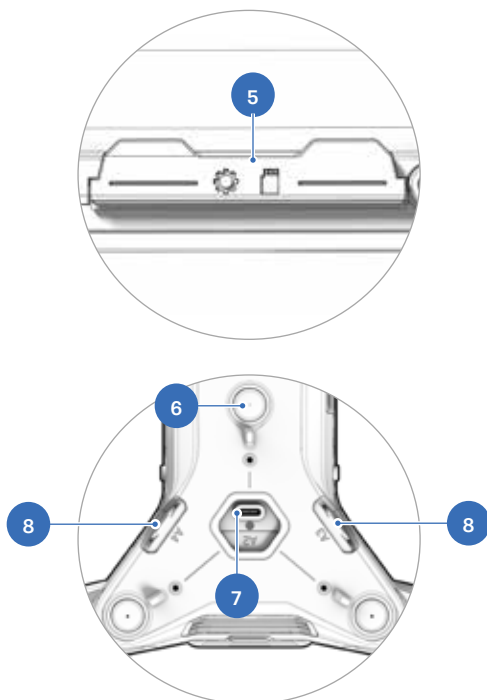
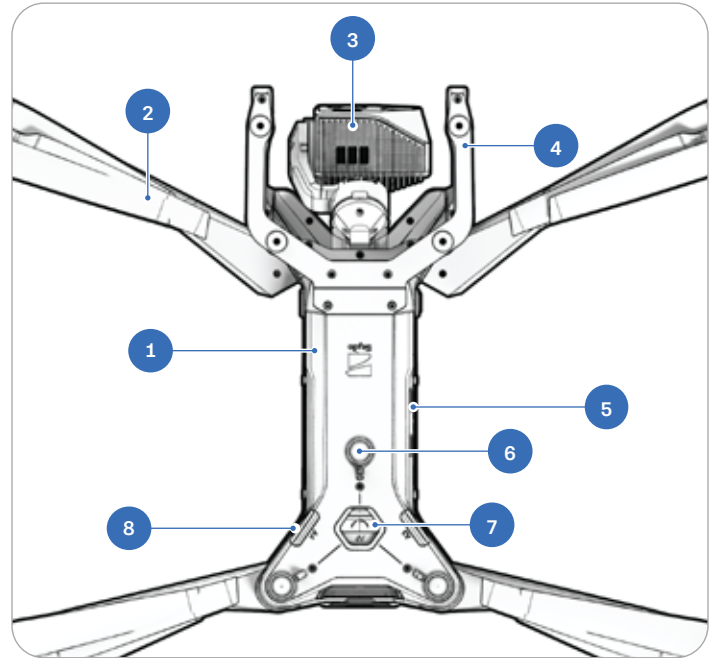

# Getting Started

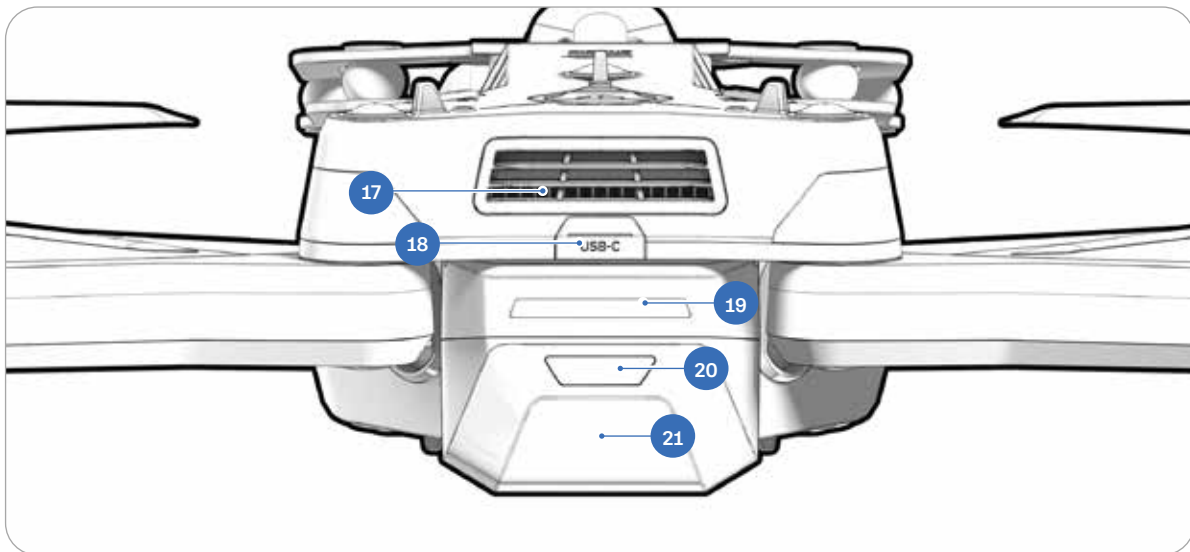
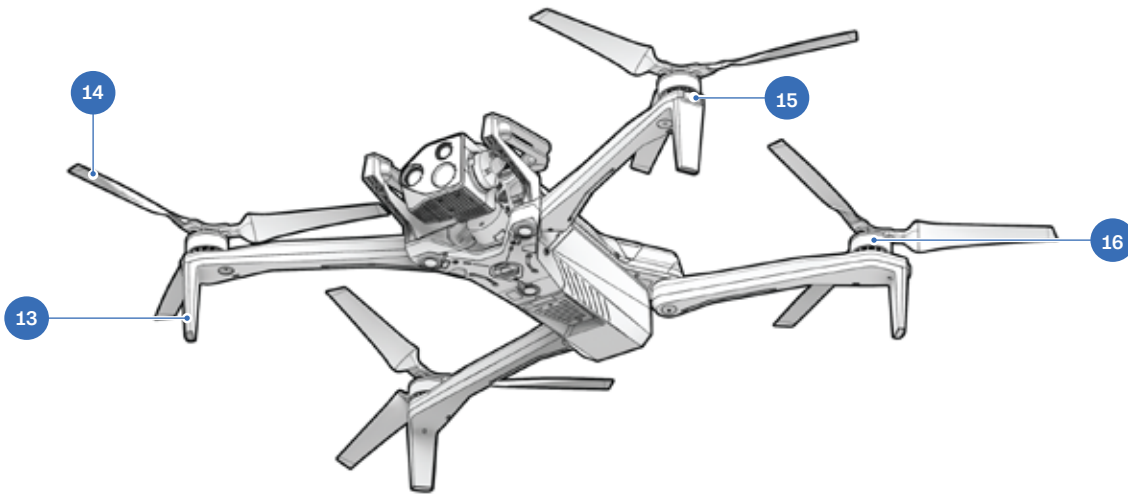

**13.** Landing feet/antennas

**14.** Propeller blades

**15.** RGB/strobe lights

**16.** Propeller motors

**17.** Cooling fan/outlet

**18.** USB-C charge port

**19.** Battery lights

**20.** Power button

**21.** Battery



*Scan for more information about the sensor packages available for purchase.*

# Skydio X10D Controller Hardware

1. Left joystick
2. Menu/Back button
3. C1 button<sup>1</sup>
4. C2 button<sup>1</sup>
5. C3 button<sup>1</sup>
6. Power button
7. Launch/Return/Land button
8. Pause button
9. Directional pad (D-pad)
10. Right joystick
11. Controller cover/antennas
12. R1 button (Shutter)
13. Right wheel
14. HDMI port
15. USB-C charge port
16. L1 button (Boost)
17. Left wheel<sup>1</sup>
18. R2 button<sup>1</sup>
19. Cooling fan
20. Neck strap<sup>2</sup> and tripod mount
21. L2 button<sup>1</sup>

<sup>1</sup>Customizable

<sup>2</sup>Neck strap sold separately

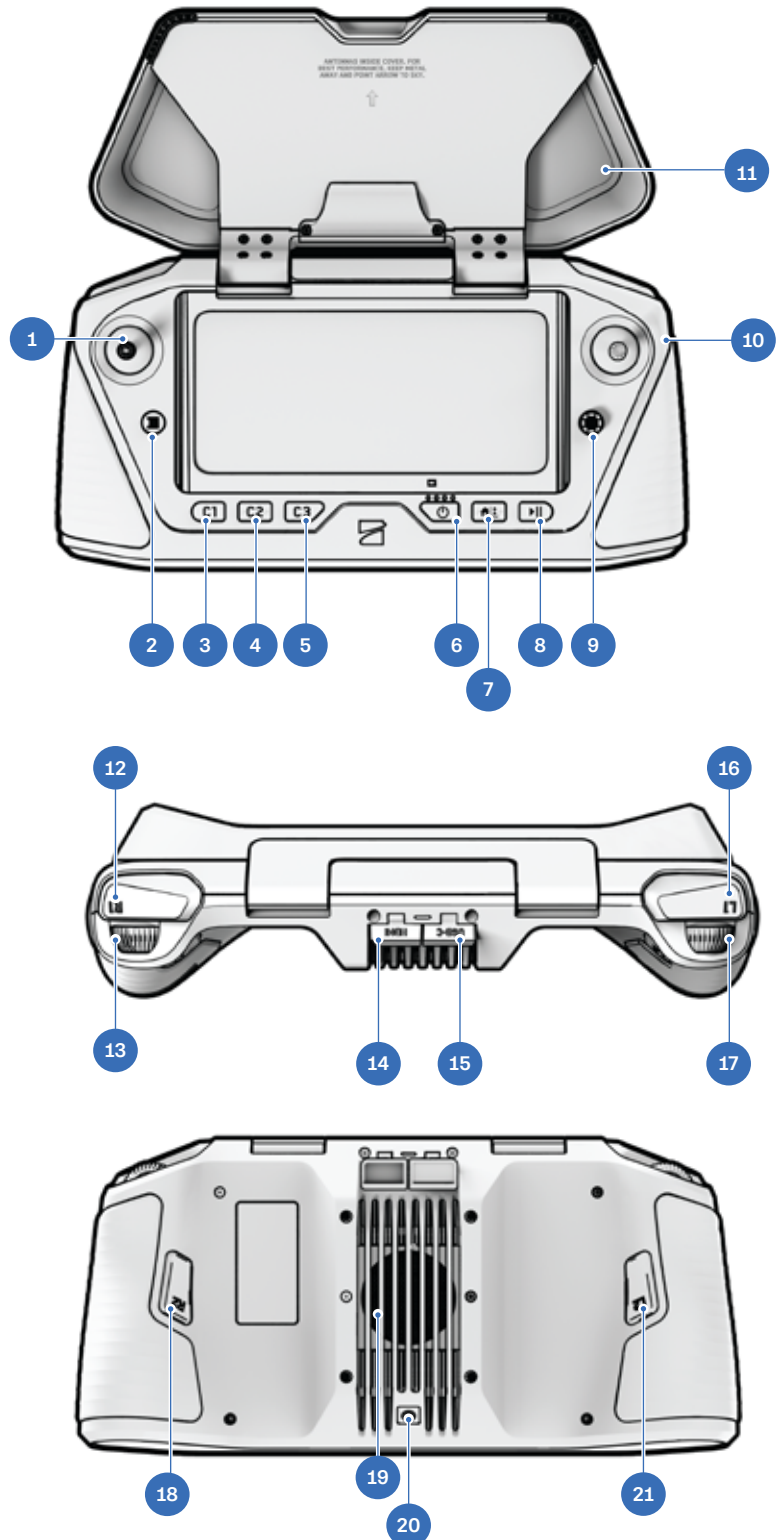

# Skydio X10D Autonomy Features

With the purchase of Skydio X10D, you have access to a powerful suite of advanced AI-pilot assistance capabilities.

Skydio X10D comes equipped with the following software features:

## Skydio Autonomy Package

---

- 360° Obstacle Avoidance
- Attitude Mode
- Crosshair Coordinates
- Low Light Flight
- Manual Flight
- Map Capture
- Motion Planning
- Object/Scene Recognition
- Offline Maps Importing
- Point of Interest Orbit
- Real-time 3D mapping
- Skydio Visual Navigator
- Subject Detection
- Track in Place (subject tracking)
- Visual Return-to-Home
- Waypoint Missions
- Zoom

# Charging Skydio X10D Batteries

Skydio X10D batteries are shipped in a state of hibernation and will not power on your drone out of the box. Your batteries will automatically exit this state once they begin charging for the first time.

## Using the Skydio X10D Dual Charger

The Skydio X10D Dual Charger sequentially charges two batteries. The Dual Charger will prioritize fully charging the battery with the highest charge level. If both batteries are depleted, it will prioritize the battery that is inserted first.

### Step 1 - Remove battery from drone

Skydio X10D batteries are held in place using a magnetic connection.

1. Firmly grip the drone chassis with one hand
2. Grip the battery with your other hand, placing your palm over the power button and wrapping your thumb under the battery
3. Using your fingers as leverage, press against the drone until the magnets disengage and slide the battery away from the sensor package



# Getting Started

---

## Step 2 - Place batteries into the X10D Dual Charger

Ensure the battery and connection pins are free of debris and interference. Gently push down to ensure the batteries are properly seated.

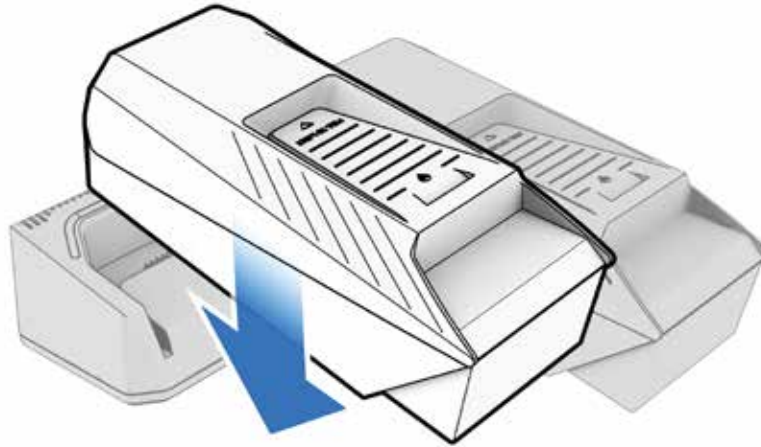

## Step 3 - Insert the power supply

Two charging ports are located on the back of the Skydio X10D Dual Charger. You may use either the 100 W USB-C power supply or the 230 W fast power supply.

Plug into a power source.

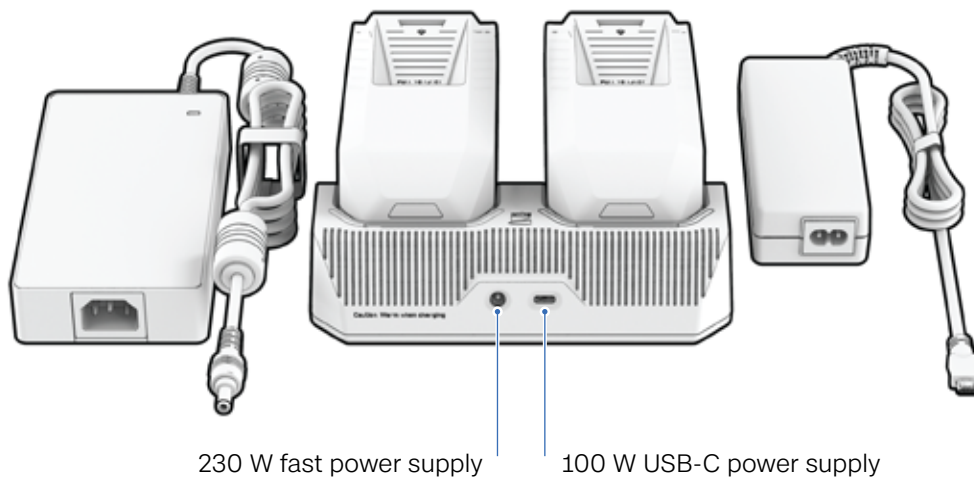

# Getting Started

## Battery Charge State

## Light Behavior on X10D Dual Charger

Actively charging	Pulsing blue
Waiting to charge	Solid blue
Charging complete	Solid green

## Power Supply

## Input

## Charge Time

230 W	20VDC, 11.5A	About 1 hour to charge a depleted battery
100 W	5-20VDC, 3A / 20VDC, 5A	About 1 hour 45 minutes to charge a depleted battery



**CAUTION:** *Third-party adapters and cables are not supported. Only use the Skydio-provided power supplies and cables to charge your batteries.*



**NOTE:** *Pass-through charging is not currently supported. This functionality will be enabled in a future software update.*

# Using Skydio X10D

### Step 1 - Insert battery

Align the battery with the rails and slide toward the sensor package until the magnets engage.

- Ensure the battery and rails are free of debris and interference
- Ensure the battery is completely seated before flying



### Step 2 - Locate the charging USB-C port

The charging port is located on the back of the drone above the battery. This is the only USB-C port that supports charging.

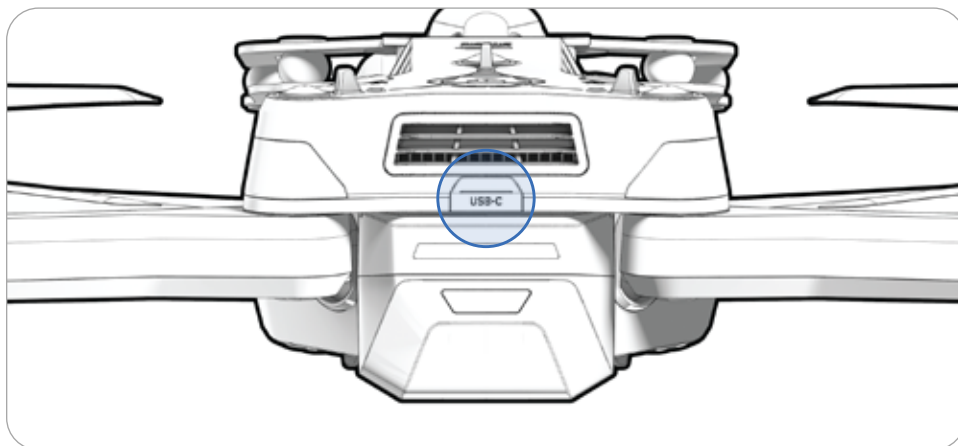

## Getting Started

---

### Step 2 - Insert the 100 W power supply

Plug into a power source.

- It will take about 2 hours to fully charge a depleted battery using the 100 W power supply

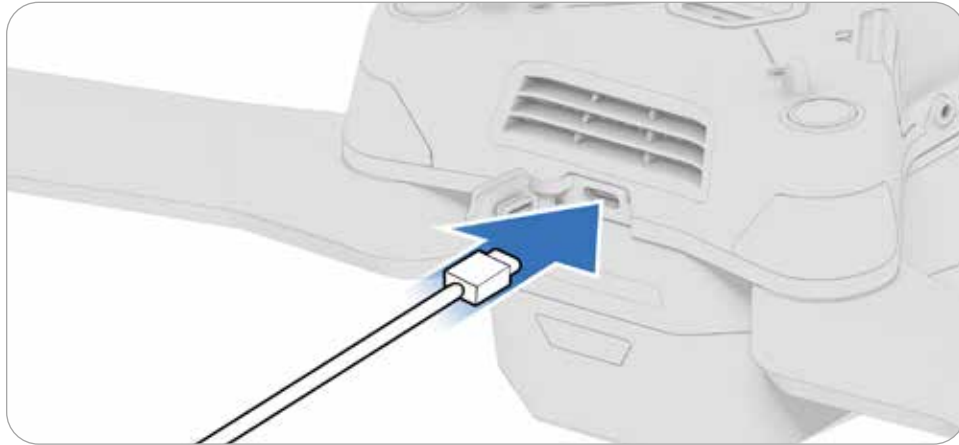

# Charging the Skydio X10D Controller

## Step 1 - Locate the USB-C port

The charging port is located on the back of the controller.

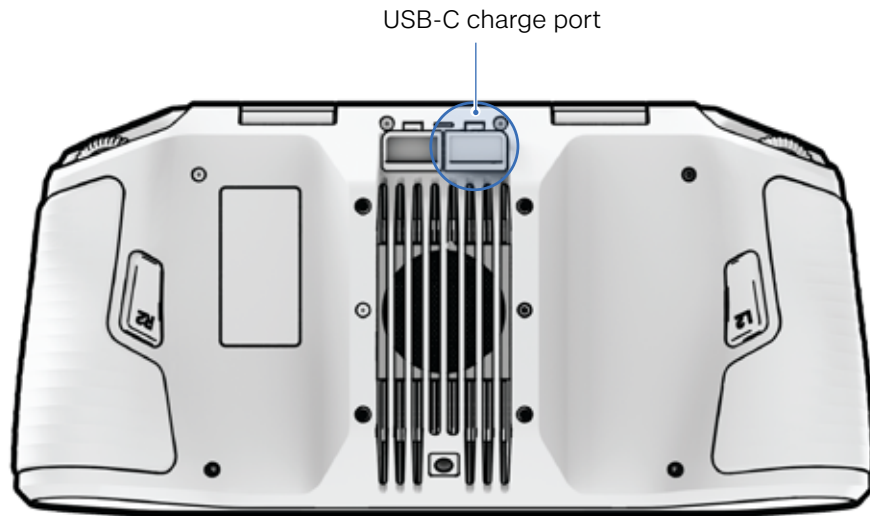

## Step 2 - Insert the 100 W power supply

Connect your Skydio X10D Controller to the 100 W power supply. Plug into a power source. The lights on the front of the controller will turn on and indicate the level of charge.

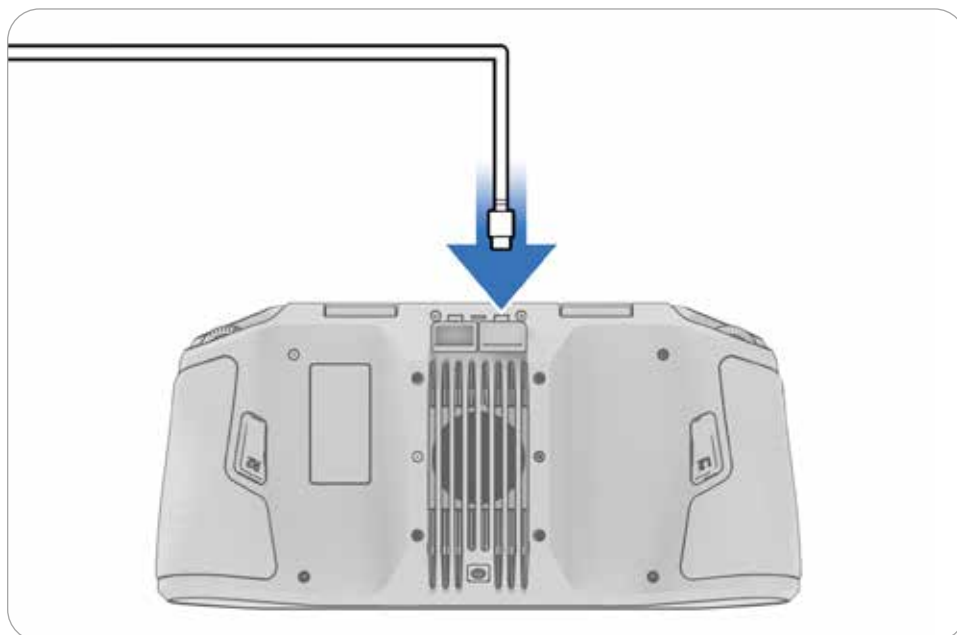

## Finding Drone Name and Battery Serial Number

### Skydio X10D UAV Name

This begins with **SkydioX10D** and can be found on the label inside the battery bay of the drone.

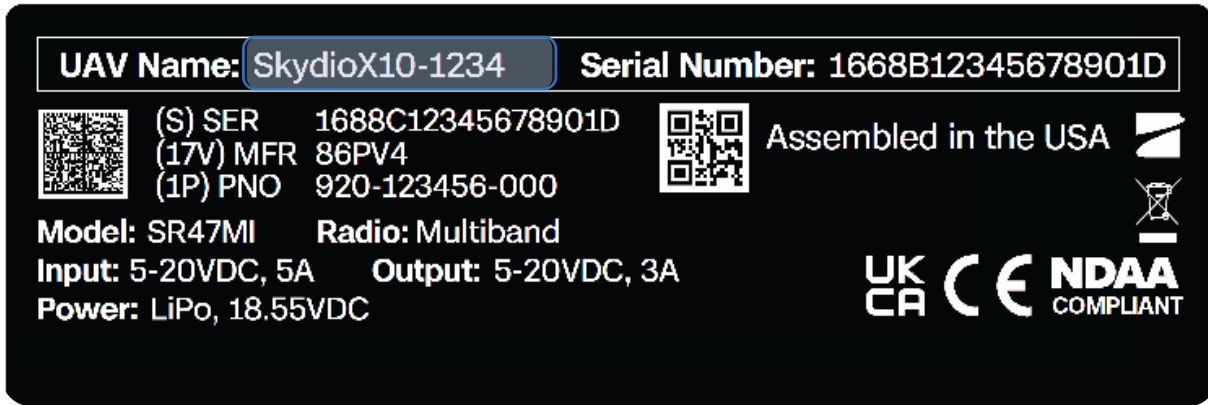

**Skydio X10D Battery Serial Number** is 16-characters and can be found on the battery label.





# Preflight

Set up your system before your first flight.

## **This section covers**

---

Skydio X10D Setup

---

Skydio X10D Controller Setup

---

Updating the Skydio X10D System

---

Encryption

---

Importing Maps

---

Battery Warming in Cold Environments

---

# Skydio X10D Setup

## Step 1 - Unfold the rear arms

Hold the drone with the sensor package facing away from you. Pull **laterally** away from the chassis until you feel the arm seat into place.

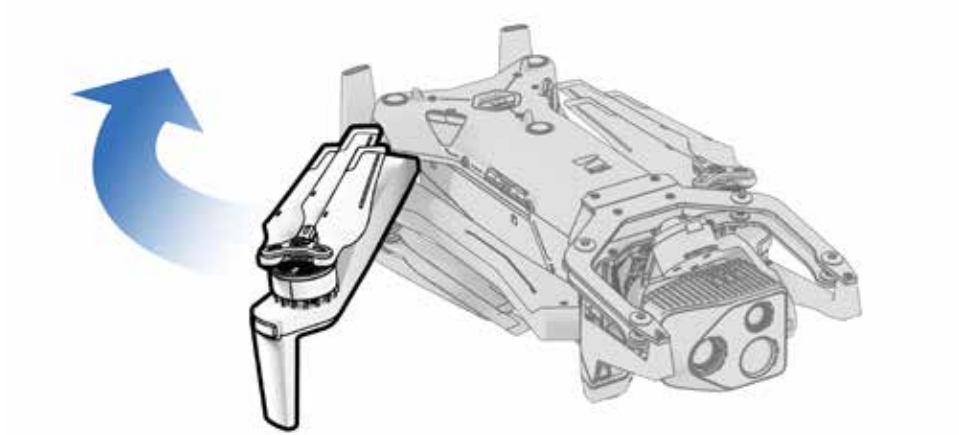

## Step 2 - Unfold the front arms

Push **down** and **forward**. Gently continue until you feel the arm seat into place.

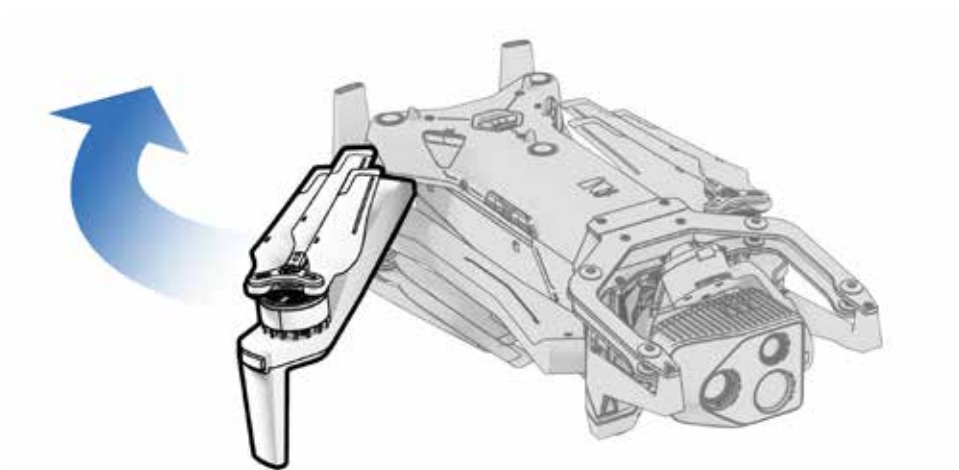

## Step 3 - Verify and format microSD cards (pre-installed)

Ensure you have two UHS Speed Class 3 (or faster) microSD cards inserted in the slots on the side of the drone.

- Minimum 256 GB
- Format your cards before flying using **Manage Data** within the **Information** menu (**Global Settings > Information > Devices > Manage Data**)

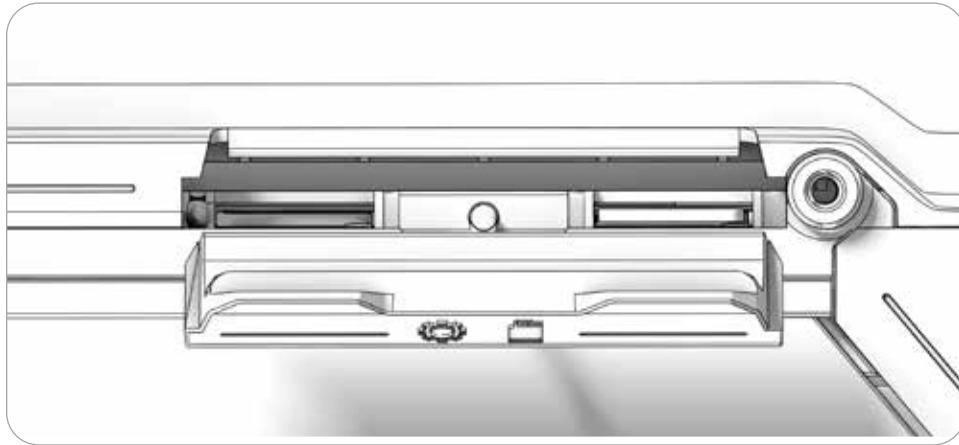

### Logs card

Scan data and records flight logs



### Media card

Stores media captured during flight

# Preflight

---

## Step 4 - Insert battery

Align the battery with the rails and slide toward the sensor package until the magnets engage.

- Ensure the battery and rails are free of debris and interference
- Ensure the battery is completely seated before flying



## Step 5 - Remove the sensor package lock

Hold the sensor package and gently pull to remove from the top of your drone.

- Save this piece to reattach when storing or transporting

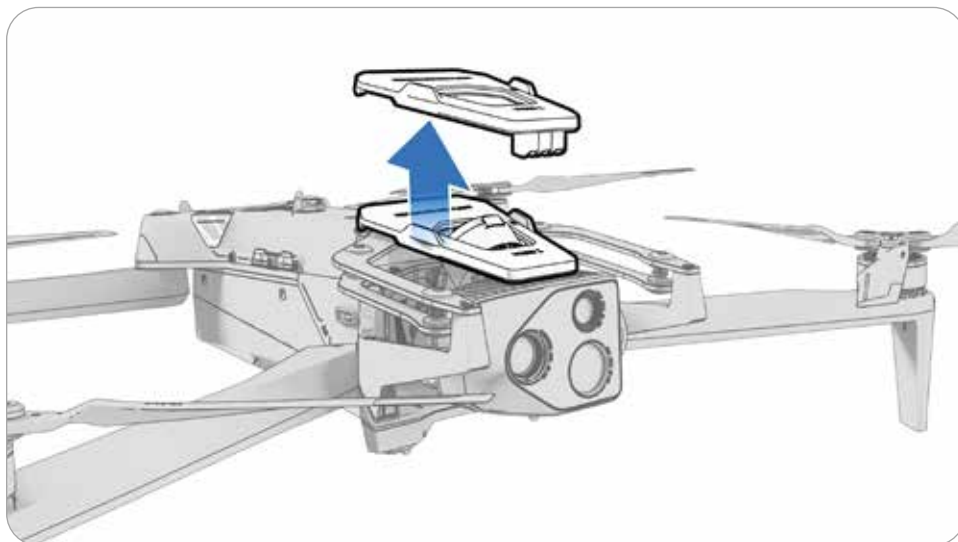

# Skydio X10D Controller Setup

## Step 1 - Power on the Skydio X10D Controller

Open the controller lid and hold the Power button for five seconds. The lights on the front of the controller will turn on and indicate the level of charge.

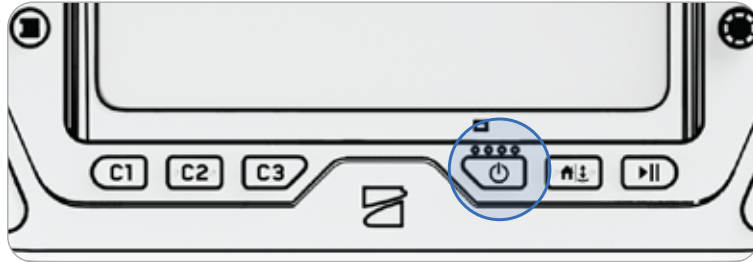

**NOTE:** While powered off, you can check the level of charge by pressing the Power button once.

## Step 2 - Set up Skydio Flight Deck

Skydio Flight Deck is the dedicated flight software on your controller. Follow the on-screen prompts to begin setup.

- Follow the on-screen prompts to begin setup.
- Create a device password to unlock the controller
- The password will be required to unlock the controller when powering on or waking from a sleep state
- Minimum six characters. Follow your organizations guidelines for password length and complexity



**CAUTION:** The password cannot be recovered or reset. Ensure that your password is entered correctly and is written down and stored in a safe location. If the password is lost, the controller will need to be replaced.

# Preflight

---

## Step 3 - Power on Skydio X10D

Press and hold the Power button on the battery for three seconds. The lights on the drone arms will turn blue as X10D powers on.

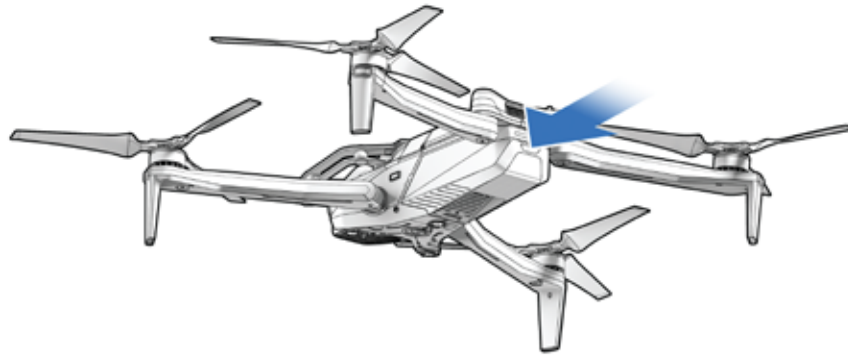

## Step 4 - Pair the drone and controller

Use the USB-C pairing cable to connect your devices. Wait as pairing completes. The lights on the drone will turn solid blue and the name of your drone will appear on the screen when pairing is successful.

Once paired, the drone and controller will automatically connect before future flights.

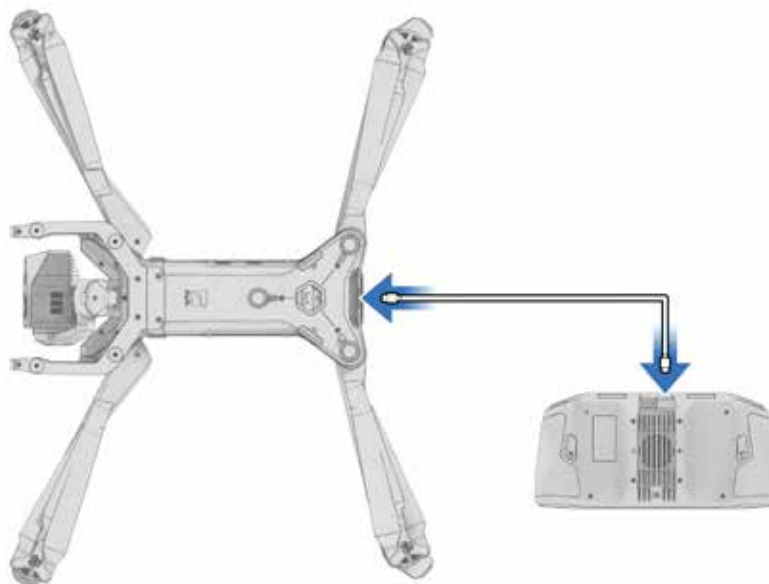

# Updating the Skydio X10D System

Updates from Skydio contain essential enhancements and fixes designed to improve performance and optimize flight controls and features for operating your Skydio X10D drone, controller, and dual charger.

## You will need:

- Computer with an Internet connection
- USB-C memory drive authorized by command or IT Security and formatted to exFAT
- The media SD card from your X10D drone (optional)
- .zip containing the offline\_ota folder with the X10D vehicle update
- .tar file Controller update

## Update your Skydio X10D Controller:

Step 1 - Insert the USB-C drive into your computer

Step 2 - Copy the .tar file to the root level of your USB-C drive and safely eject

Step 3 - Power on the controller

Step 4 - Insert the USB-C drive into the port on the back of the controller

- Select the Global Settings and Information menu
- Select Controller Update and Select Update

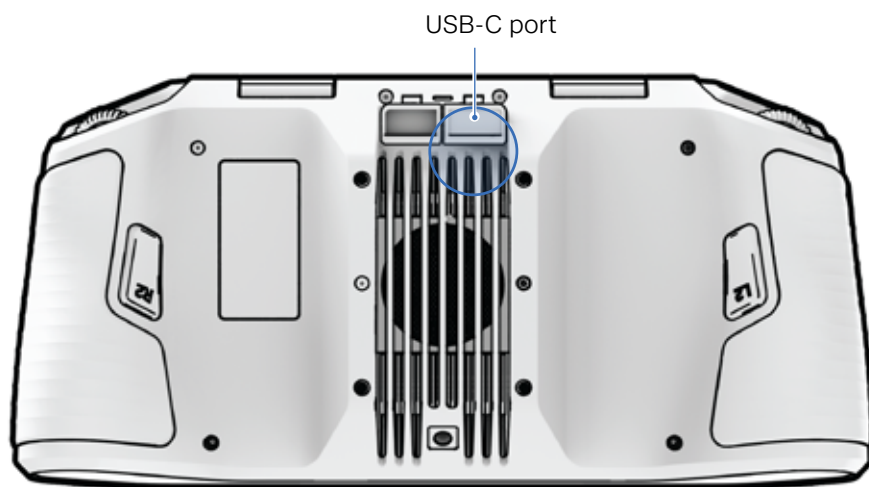

Step 5 - Navigate to the memory drive root folder

Step 6 - Select My Files

- Select USB Storage 1 and the Controller Flashpack.Tar file and Done
- The update will begin, and your controller may restart multiple times
- Remove the memory drive when the update is complete

## To update your Skydio X10D using a USB-C memory drive

Step 1 - Insert the USB-C memory drive into your computer

Step 2 - Extract the .zip offline\_ota folder

Step 3 - Copy the folder to the root level of the USB-C memory drive

- Ensure the USB-C memory drive contains only the offline\_ota folder. If multiple update folders are present, the drone may not install the update correctly.

Step 4 - Insert the USB-C memory drive into the rear USB-C port on the drone

- The update will begin automatically
- The update status is reflected in the light feedback
- The process may take several minutes

## To update your Skydio X10D using the media SD card

Step 1 - Eject the Media SD card from your X10D

Step 2 - Insert the Media SD card into your computer (using an adapter if necessary)

Step 3 - Extract the .zip offline\_ota folder

Step 4 - Copy the folder to the root level of the media SD card

- Ensure the media SD card contains only the offline\_ota folder. If multiple update folders are present, the drone may not install the update correctly.

Step 5 - Insert the Media SD card back into the media port on the drone

- The update will begin automatically
- The update status is reflected in the light feedback
- The process may take several minutes

Update Status	Light Feedback
<b>Initializing</b>	Solid yellow
<b>0-25%</b>	1 arm flashing yellow light
<b>25-50%</b>	1 arm solid yellow / 1 arm flashing yellow
<b>50-75%</b>	2 arms solid yellow / 1 arm flashing yellow
<b>75-100%</b>	3 arms solid yellow / 1 arm flashing yellow
<b>Complete</b>	4 arms solid green light
<b>Error</b>	Flashing red



Visit How to use [Skydio Fleet Manager for Offline Drones](#) to update your X10D to access the update package using your portal account

# Encryption

An encryption key that enables you to encrypt your media is included with your Skydio X10D. You will need to pair that Encryption Key to your X10D and store it with your vehicle. You can enable and disable the encryption settings in the Skydio X10D Controller Flight Deck. When the media encryption is enabled, all images and videos captured by X10D will be encrypted and hidden in the Media Review tab.

### To enable encryption:

Step 1 - Power on and pair the Skydio X10D and controller

Step 2 - Insert the Encryption Key into the rear USB-C port on the X10D

- The Encryption Key lights will begin blinking and a notice will alert you to remove the key

Step 3 - Select Global Settings >

Information menu > your drone name

Step 4 - Select Encryption and Enabled

### To disable encryption:

Step 1 - Select Global Settings >

Information menu > your paired drone

Step 2 - Select Encryption and Disabled

- If Disable Encryption is selected, all media captured will not be securely encrypted. You will be able to review your media in the Media tab.

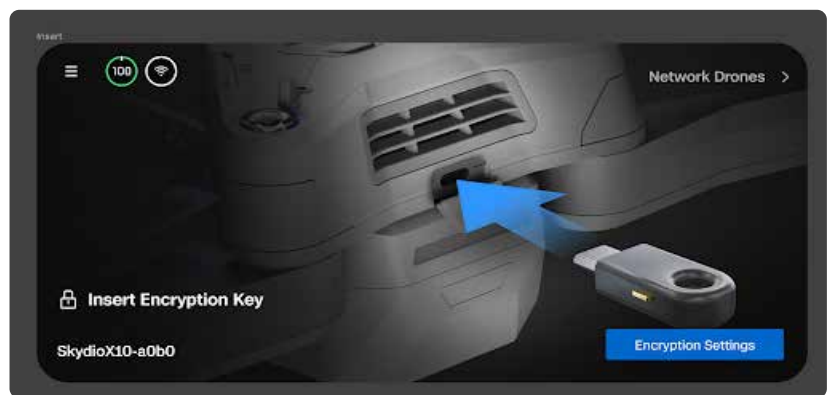

### To Decrypt media to view and transfer to your device:

Step 1 - Insert the Encryption Key into the rear USB-C port on the X10D

- The Encryption Key lights will begin blinking

Step 2 - Remove the Encryption Key when the lights stop blinking

Step 3 - Attach one end of the USB-C cable to the rear USB-C port on the X10D

Step 4 - Attach the other end to your device and import your decrypted media

- Windows OS will recognize X10D as an external hard drive
- Mac OS will utilize the Photos app or Image Capture app to transfer media



**WARNING:** Pairing an Encryption Key assigns the key to that X10D. It is essential that you store the Encryption Key with the X10D. Using a different Encryption Key will overwrite the original pairing, erasing the previously captured media.

# Importing Maps

Upload and view KML, GeoJSON, or GeoPDF files directly to the controller as base and overlay map layers, toggling them on or off at any time during flight. Import and convert these files into the controller's native map engine before use. This enables pilots to participate in federal wildfire and emergency response operations that require standardized GeoPDF and KML layers, and helps inspectors and responders clearly see assets, zones, and restricted areas during missions.

Step 1 - Load your map files onto a USB-C memory drive

- Ensure that the memory drive is formatted to exFAT
- Insert the USB-C memory drive or adapter into the controller
- Select the Information menu and Import Maps

Step 2 - Select the Information menu and Maps

- Navigate to the storage device
- Select the maps to import

Step 3 - Select Done

- Wait for your maps to import
- Select View Map Library to review your imported maps
- Select Map Layer in flight: From the flight screen, select the Map Menu > Layers > Toggle on/off individual base and overlay map layers.

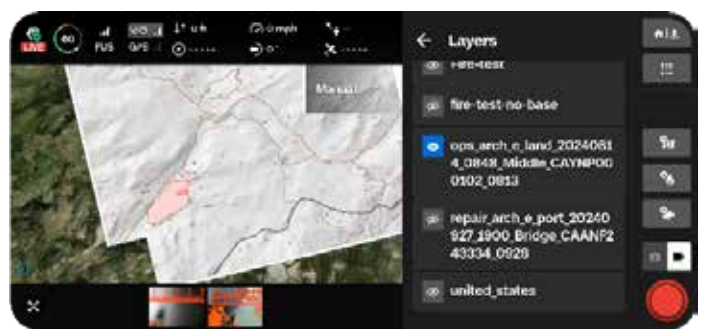
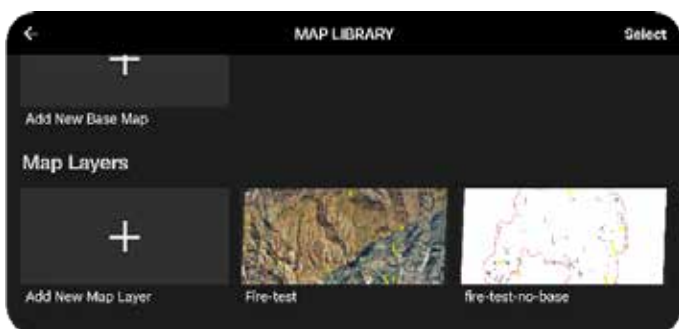

Set the Skydio X10D controller to Online mode to connect to a WiFi network. Toggle on to access updates, download maps, and stream a live video feed. Toggle off to retain flight security. Visit [How to access the WiFi on your Skydio X10D controller](#) for detailed information.

# Battery Warming in Cold Environments

For extremely cold environments, the Skydio X10D battery features self-warming technology to enable flight within 5 minutes.

If the X10D battery is below 32°F (0°C), Skydio X10D will be prevented from launching. You will need to pre-warm your batteries before you can launch.

- Battery self-warming is supported down to -4°F (-20°C).
- Skydio X10D will allow launching with reduced performance while continuing to operate the self-warmer until full performance is restored.
- A battery must have at least 30% charge to self-warm.
- A fully charged battery is strongly recommended when flying in cold weather.
- Flight time will be reduced in cold temperatures.
- Minimize aggressive maneuvering in extremely cold environments.



### Pre-warming Skydio X10D Batteries

If Skydio X10D detects that a battery is too cold to launch, the battery will automatically begin self-warming. Launch will become unblocked when the battery is sufficiently warmed for the given state of charge.

You also have the option to prewarm a battery before inserting into the drone:

#### Step 1 - Triple tap the battery button to begin the self-warming process

- The lights on the battery will turn orange during the self-warming process
- Triple tapping again will end the self-warming process

#### Step 2 - If the battery is cold enough it will begin self-warming

- When self-warming is complete, the lights on the battery will briefly turn blue and then power off

#### Step 3 - Insert the battery into the drone and power on

- If the self-warming was still in progress prior to inserting, it will continue while the battery is in the drone
- Launch will become unblocked when the battery is sufficiently warmed for the given state of charge

## Icing Detection

Cold, wet conditions can cause ice to form on rotor blades, reducing lift and flight stability. Vehicle Icing Detection is a safety feature that helps prevent incidents during cold and wet conditions by automatically identifying early signs of icing and alerting you before performance is affected.

- Continuously monitors flight performance and detects reduced lift or increased drag that may indicate ice buildup
- Icing alerts may appear in temperatures up to 46°F (8°C)
- Enabled by default

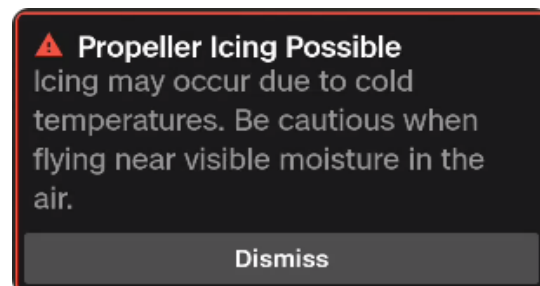
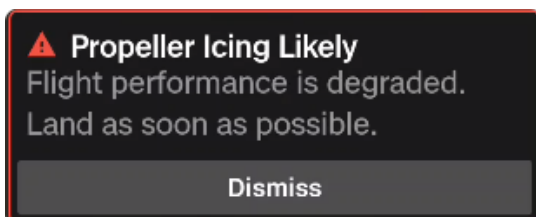



# Skydio Flight Deck

Skydio Flight Deck is the dedicated flight software on your controller. In this section you will learn about core menu locations and setting customizations.

## **This section covers**

---

Gate Screen

---

Global Settings

---

Flight Controls

---

Return Behaviors

---

Sensing (Obstacle Avoidance)

---

Display

---

System Status

---

Quick Actions

---

# Gate Screen

After powering on and connecting to your drone, the first screen you will see is the **Gate Screen**. This screen is the first step to starting your flight, switching modes, or configuring preflight settings.

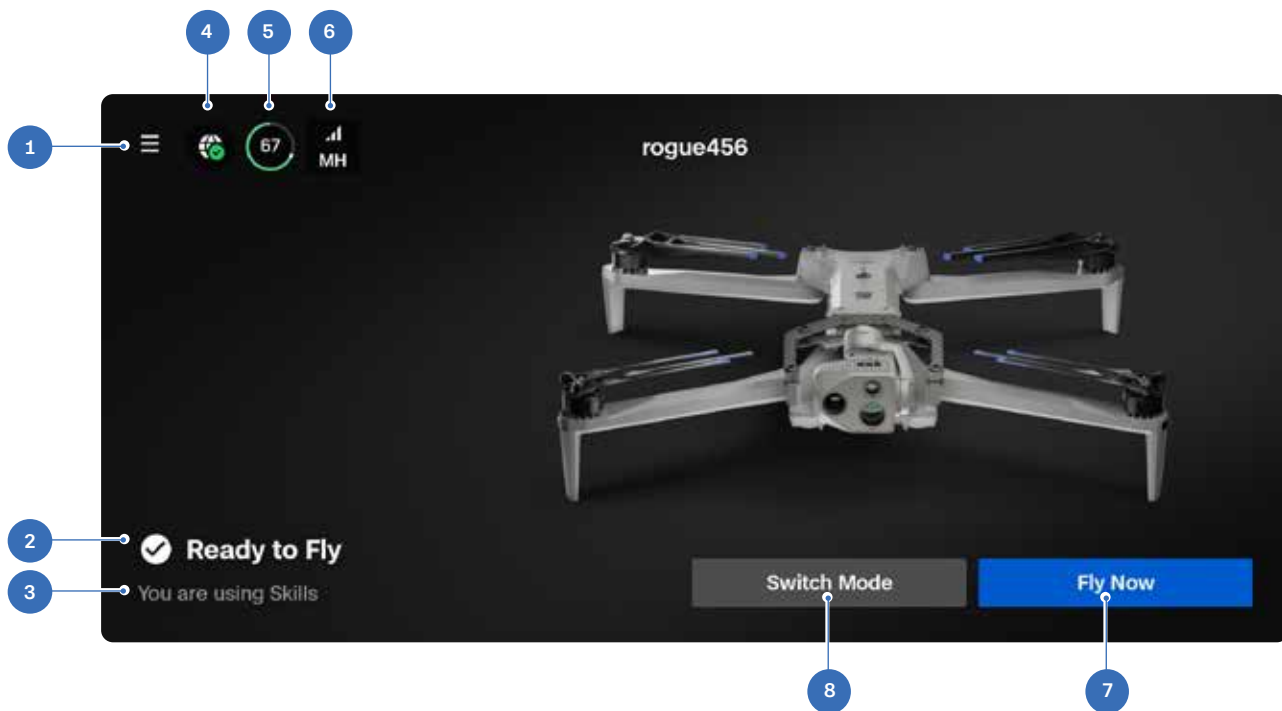

1. Global Settings
2. Flight Status
3. Flight Mode
4. WiFi Enabled Indicator
5. Drone Battery Level
6. Radio Signal Strength
7. Fly Now (Flight Screen)
8. Flight Mode Selector



**WARNING:** The X10D is shipped in 2.4 GHz Max Power mode for optimal range performance. Adjust the power level by selecting Global Settings > Information > Drone ID under Devices > Radio > 2.4 GHz Power Level to prevent unauthorized power levels in certain regions.

# Global Settings

The Global Settings menu is accessible before and during flight. You will use this menu to navigate to a variety of settings, such as low battery behaviors, stream layouts, and obstacle avoidance behavior.

Select the Global Settings icon in the top left of the screen to access the following menus:

- Offline User sign In
- Media
- Information
- Flight Controls
- Sensing
- Return
- Lighting
- Sharing
- Display
- Sound
- Attachments
- Radio
- System Status

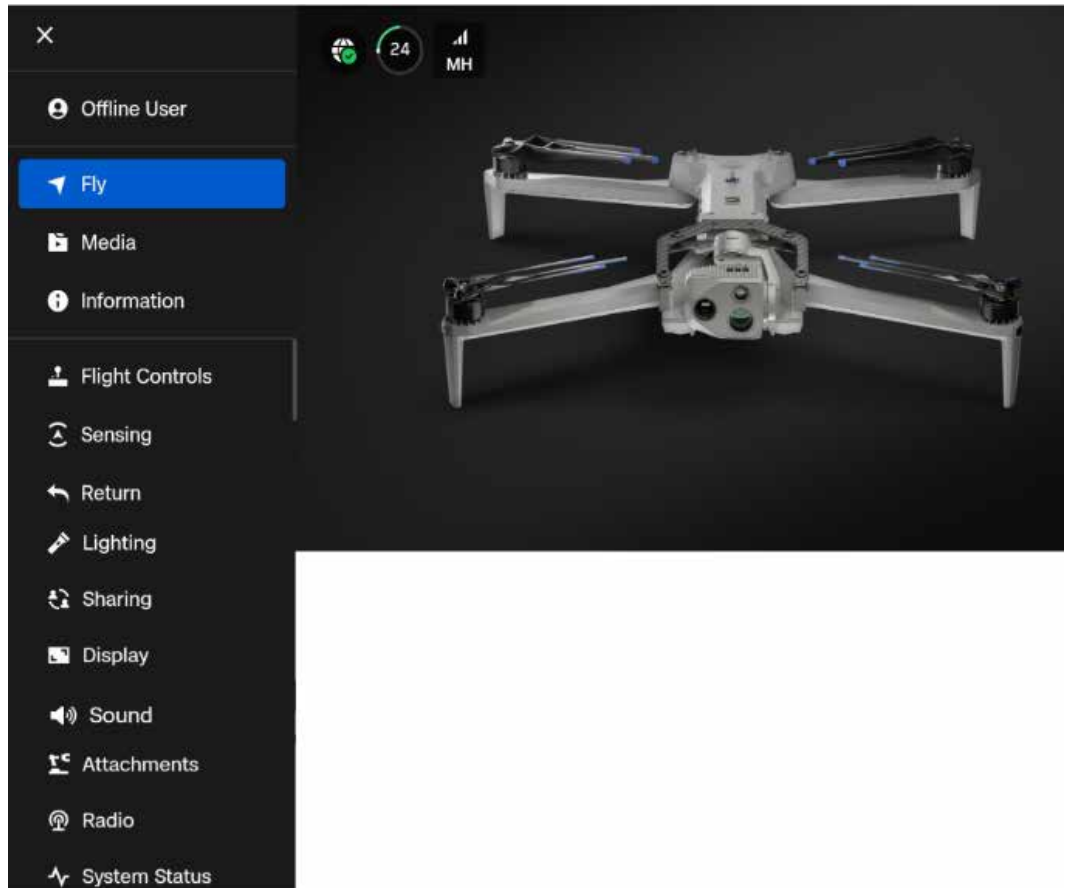

**Offline User:** Sign in to your organizations admin account to access the controller updates.

# Media

Media menu to view photos, videos, and scans from your recent flights.

- Select an image or video to view
- Press and hold on a thumbnail to select multiple or delete

If you captured photos using **Interval**, all photos captured will appear as a single stack. Selecting the stack will allow you to scroll through individual images one by one.

Only standard color and thermal JPGs will display in the Media menu. To access your DNG or RJPG files, you must transfer the files from your drone.

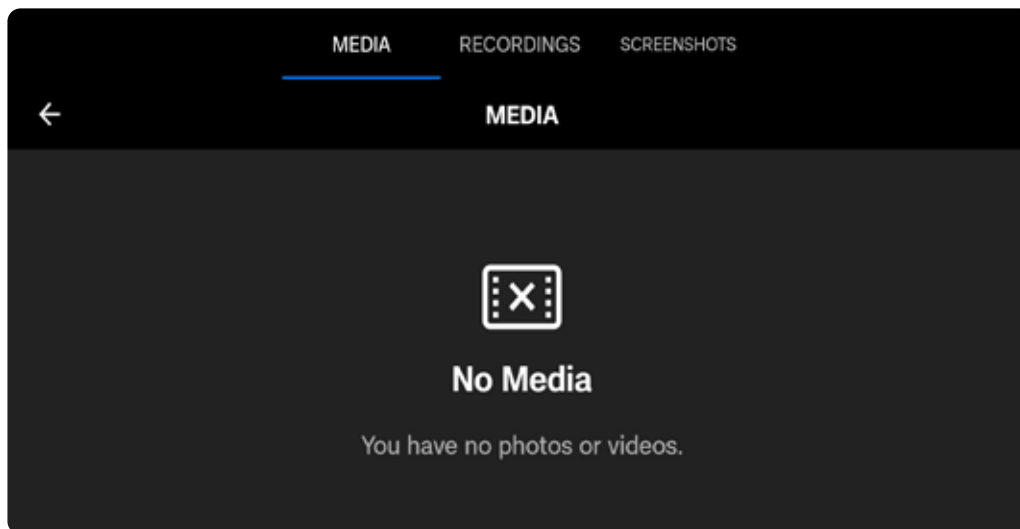

### Screen Recording:

- Toggle on/off in the display menu

### Screenshot:

Users with the special access to the screen record feature can now assign the screenshot function to a controller button through the button mapping menu. This enhancement makes it easier to capture the flight screen without interfering with flight or camera controls.

- Press and hold the mapped button for 6 seconds
- The screenshot function can be mapped to either C1, C2, C3 or R2.
- A message will display that the screenshot was saved



**NOTE:** Media is not accessible inflight.

# Information

While the Skydio X10D vehicle and controller are paired, the Information menu provides access to settings radio frequency selections, the map library, and more.

## Devices

Lists the name of the drone that is currently connected, as well as other X10D drones that have previously paired to the controller.

Verify software versions by selecting the name of a drone.

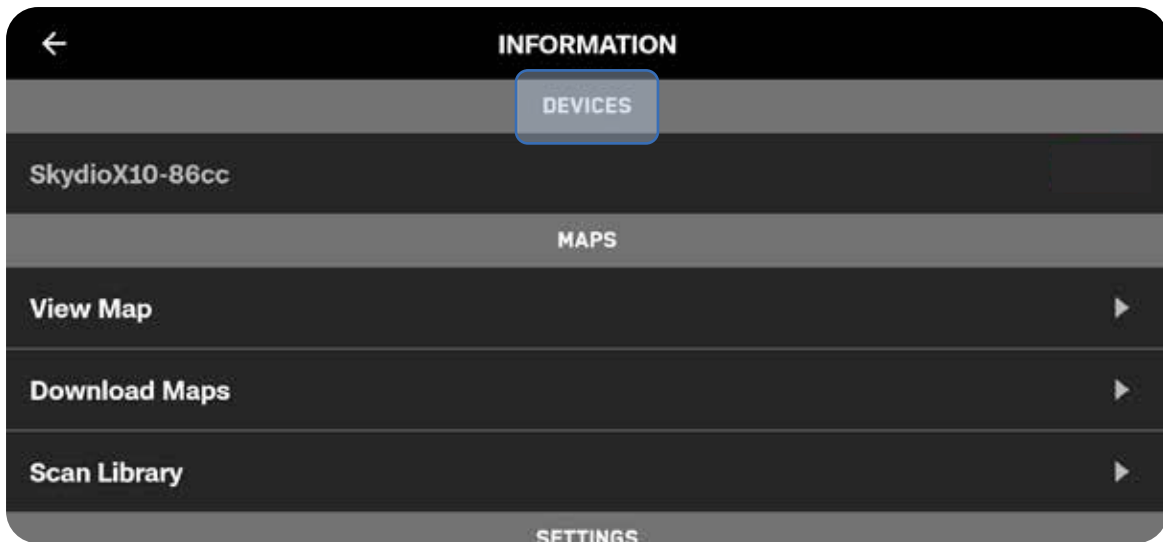

## **Manage Data**

Select to format the Log and Media cards or Factory Reset your drone.

## **Locate Skydio X10D**

In the event that your Skydio X10D is lost, you may view its last known location. If the Coordinate setting is enabled, the latitude and longitude of the current or last known location will be displayed.

## **View Last Flights**

Displays the feed that was last viewed from the Flight Screen, even if the drone is not connected. Designed to assist you with locating your drone in the event of a crash, emergency landing, or low battery landing in an unintended location.

## **Export Files**

Export flight logs and telemetry data.

## **Overwrite Media**

Manage your media storage by automatically deleting old media to ensure you always have enough storage space to start a new flight. Select Delete Oldest Media to automatically delete the oldest media stored on the microSD memory card.

## **Anti-flicker**

Adjust anti-flicker settings if you experience flickering in your video. This setting is for users located outside of North America, in countries where the frequency of the alternating current in household electrical outlets is 50 Hz.

## Maps

### View Map

View your current location, search, and configure map settings.

The location of Skydio X10D, the controller, Launch Point, and Home Point (if set) are all indicated on the map.



Skydio X10D



Controller



Launch Point



Home Point

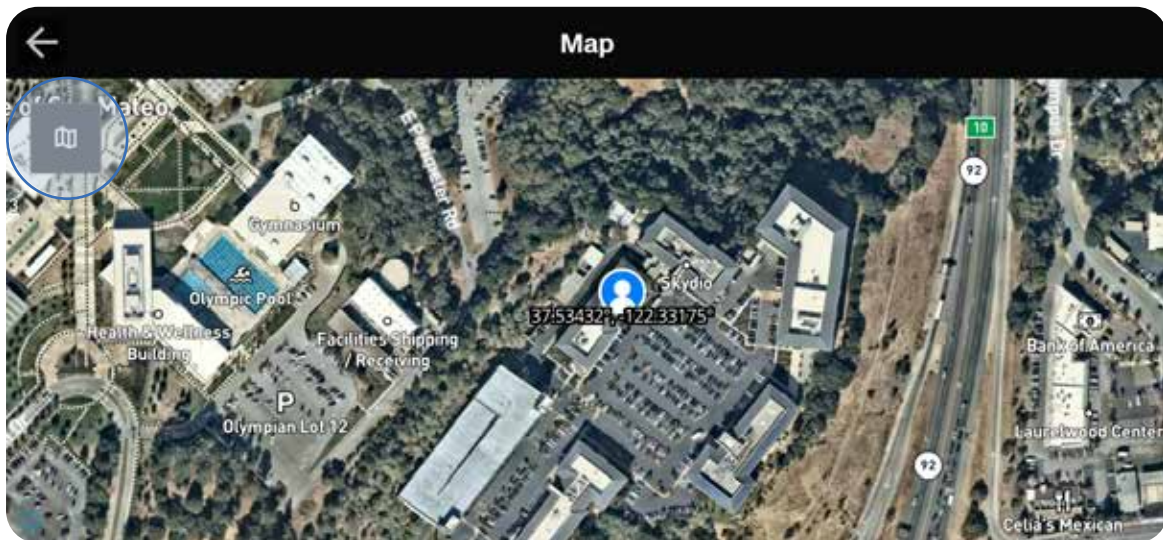

## Waypoint Mission

Stores the most recent Waypoint Mission. Press and hold on a waypoint to delete it. Press and hold on the map to add a waypoint or delete all waypoints. Set your Heading, Gimbal Angle, and Altitude in the Waypoints settings tab. Only one Waypoint Mission will be saved at a time.



# Skydio Flight Deck

## Scan Library

View or repeat saved Map Capture scans. You also have the ability to import a previous Map Capture.



**INFO:** For more information, visit [How to use Map Capture](#).

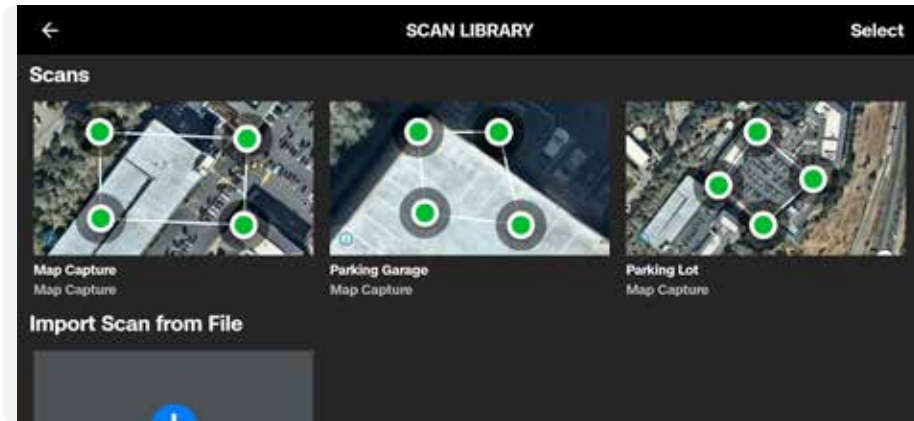

**NOTE:** Only *.mission* files created from Skydio Map Capture are supported when importing.

## Languages

Skydio Flight Deck is available in Spanish and Ukrainian as selectable language options. Menus, notifications, and system text will update instantly once a language is selected.



# Support

### **Tutorials**

Includes step-by-step instructions for actions such as calibration.

### **Hand Wave Calibration Guide**

For use in environments with magnetic interference such as cars, metal bars, power lines, etc.

### **About**

View the current software version of the X10D Controller, the email associated with your account, and your organization.

### **Skydio Support Logs**

To assist the support team and better troubleshoot any issues or questions you may have, we may require you to send logs or other data from your drone to help us determine the root cause of any issues.

If you have any objection to this, please let the support team know. We will never review your videos or data without your permission. Do not reformat or factory reset your Skydio drone prior to contacting our support team.

### **Legal**

View legal documentation such as the Skydio Safety and Operating Guide.

# Flight Controls

Use this menu to customize your joystick controls, input mapping, Height Ceiling, and altitude limits.

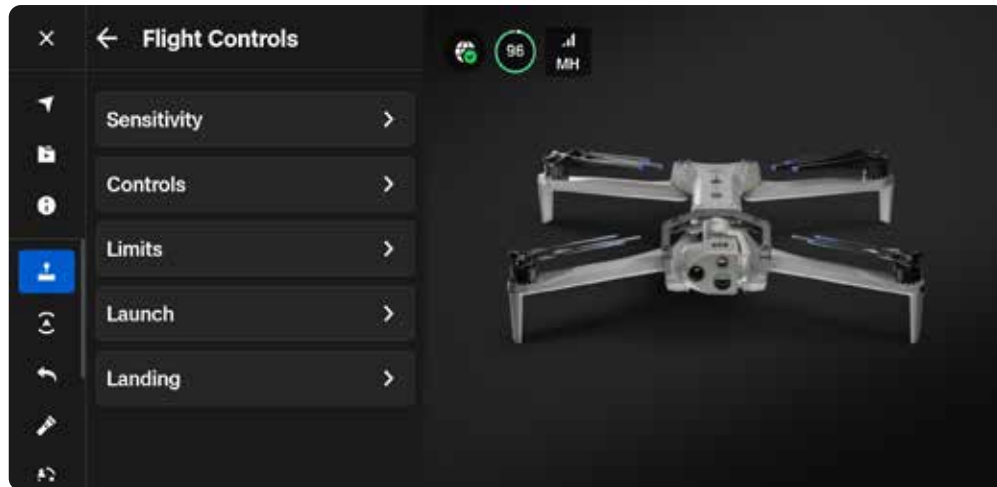

Moving the joysticks allows you to adjust the roll, pitch, yaw, and throttle of the drone.

- **Roll** - Controls left and right movement
- **Pitch** - Controls forward and backward movement
- **Yaw** - Changes rotation around the vertical axis
- **Throttle** - Controls altitude

## Sensitivity

### Gimbal Pitch

Controls how quickly the camera sensor package moves up and down.

- Default - 18%

### Flight

Allows you to customize the maximum allowed speed for roll, pitch, yaw, and throttle.

Default sensitivity:

- Roll - 35%
- Pitch - 35%
- Yaw - 45%
- Throttle - 100%

### Rapid Descent

Allows you to increase the speed to the maximum descent rate when pressing and holding Boost (L1 button).

- Descent speed: 27 mph (12 m/s)



**NOTE:** Increase pitch sensitivity to increase the maximum speed of the drone.

## Controls

### Battery

Displays Skydio X10D Controller battery level.

### Control Mode

Determines how your controller joysticks will maneuver X10D. Select between Mode 1, 2 (default), and 3.

### Input Mapping

Allows you to customize buttons and wheels with the following options:

- Toggle Map
- Toggle Camera
- Obstacle Avoidance (Close, Minimal, Disabled)
- Cycle Display Layout
- Cycle Thermal Palettes
- Cycle Full Screen View
- Reset Sensor Package
- Toggle Strobe Lights
- Toggle RGB Lights
- Stop at Structure
- No Function

Customizable buttons include: C1, C2, C3, L2, R2.

You can also invert your wheel directions, assign Exposure Compensation to your Right Wheel (instead of Zoom), or assign No Function to your wheels.

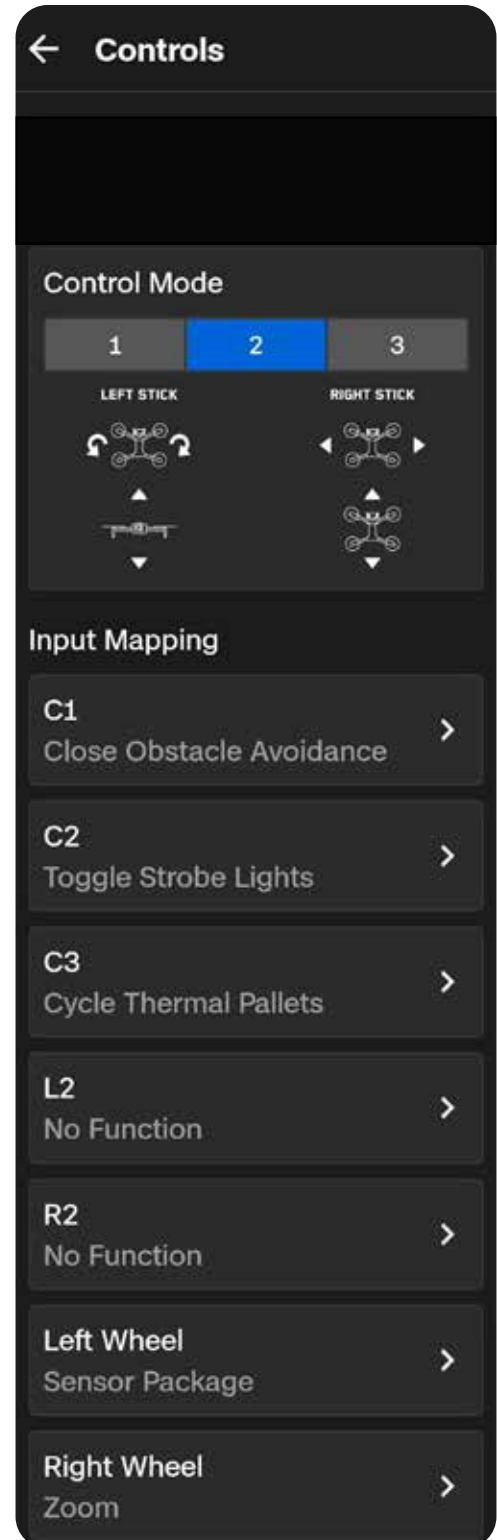

## Action Wheel

Assign functions to your controller D-pad and quickly preview and select functions in flight.

Once functions are assigned, hold the Back button on the controller to bring up the Action Wheel menu. While holding the Back button, press the D-pad up, left, or right to execute that function

## Camera Dragging

Drag your finger on the screen to pitch the sensor package and yaw the drone to look around.

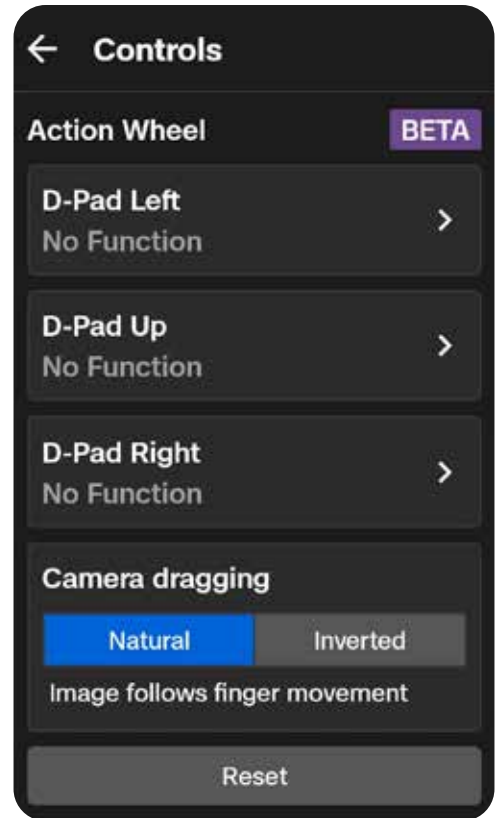

## Control Mode

By default, flight controls are set to Mode 2.

In Mode 2, the left joystick controls the elevation and horizontal rotation of the drone, and the right joystick controls the forward, backward, and lateral movements of the drone.

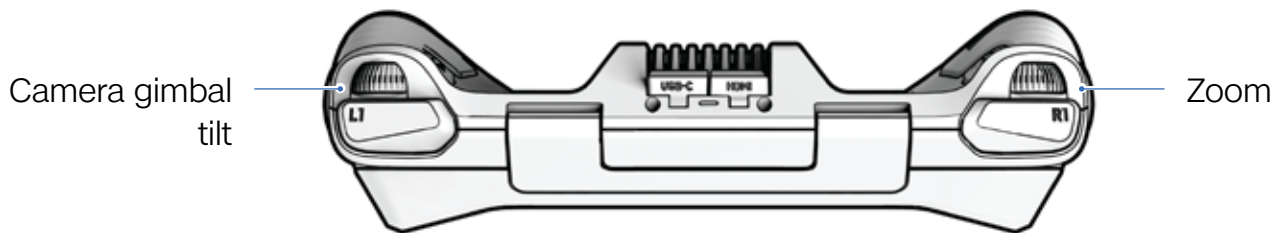
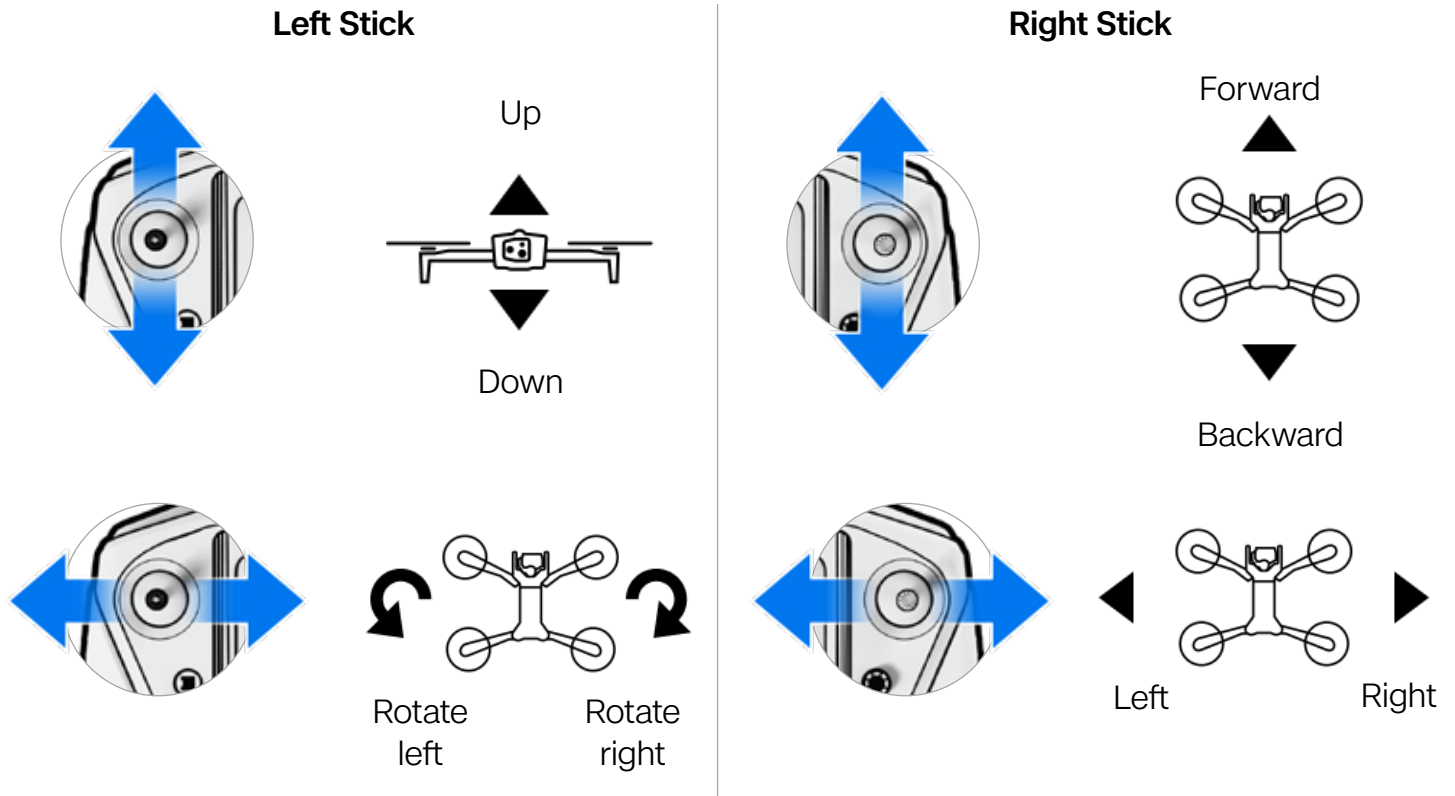

## Limits

**Height Ceiling:** when enabled, allows you to set the maximum allowed drone altitude above the Launch Point. Height Ceiling settings persist across flights and power cycles.

- Minimum: 10 ft (3 m)
- Maximum: 1500 ft (457 m)

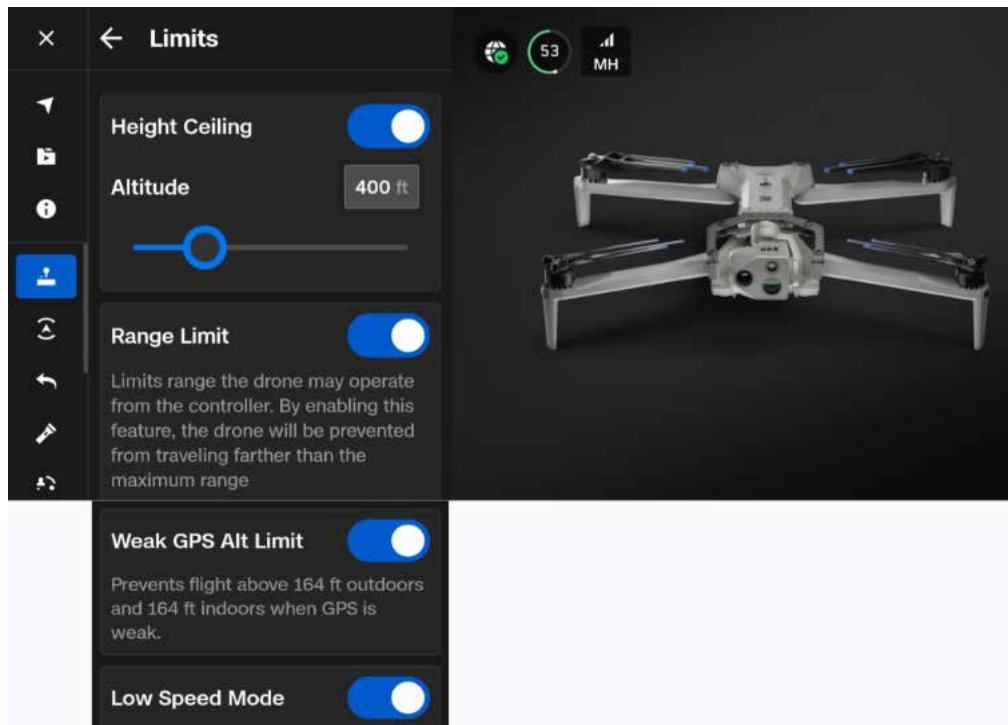

**Range Limits Geofence:** allows for precise control over a defined maximum range (164 to 32,808 ft / 50 to 10,000 m). When the drone reaches the limit, it will stop and hover.

- To fly beyond the geofence, dynamically increase the distance (up to 10 km) or toggle off
- The geofence is centered on the controller's GPS position
- If the controller GPS is lost during flight, the geofence center point freezes at the last valid controller location.
- If the controller has never provided a valid GPS, the center point defaults to the launch location

**Weak GPS Alt Limit:** when enabled, prevents flight above 164 ft (50 m) when GPS is weak.



**WARNING:** Toggling Weak GPS Alt Limit OFF disables the altitude limit and your drone will fly using only visual navigation. To reduce the risk of an emergency landing, maintain a flight path near surfaces and objects.

**Low Speed Mode:** toggle on to enable a maximum flight speed of 3 m/s for safer operation around people.

## Sensing

Use this menu to adjust autonomous flight behaviors and select vehicle navigation options, toggle GPS off, and launch in Attitude Mode.

### Flight Environment

Select either Standard or Low Light to best represent your flight environment

**Standard (default)** - flight in normal daytime or in brightly lit conditions (i.e. indoors)

**Low Light** - flight at night or in low-light conditions with poor visibility.

### Obstacle Avoidance

When flying near obstacles your drone will follow your selected distance setting. Choose between Standard, Close, and Minimal.

**Standard (default)** - Drone stays 24 in (60 cm) away from obstacles (15 in, 39 cm in narrow spaces)

- Top ground speed: ~36 mph (16 m/s)

**Close** - Drone stays 6 in (15 cm) away from obstacles (5 in, 13 cm in narrow spaces)

- Top ground speed: ~18 mph (8 m/s)

**Minimal** - Slight course corrections to avoid obstacles, but primarily relies on the pilot to avoid collisions.

- Top ground speed: ~18 mph (8 m/s)

**Disabled (toggle off)** - Skydio X10D will not avoid obstacles and there is a high risk of collision

- Top ground speed: ~45 mph (20 m/s)

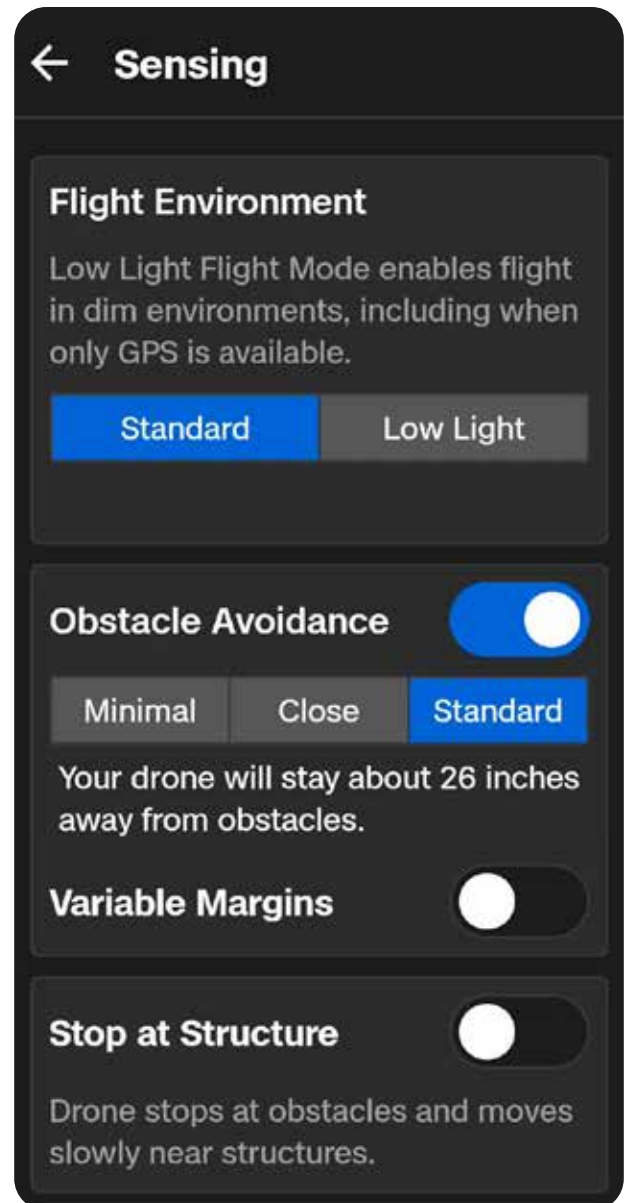

## Variable Margins

Skydio X10D uses AI and visual navigation to dynamically, and temporarily, reduce obstacle avoidance margins when moving through narrow spaces. Margins will also dynamically expand if the drone detects environmental dangers, such as wind.

Enabled by default. Disable to turn off the dynamic margin behavior.

## Stop at Structure

Perform finer, more controlled inspections on structures such as bridges or building facades.

When enabled, your drone will not deviate from its course when it is within 8 ft (2.5 m) of a structure.

The drone will reduce speed and maintain position, allowing for more precise maneuvering in the immediate vicinity of the structure.

- Adjust the maximum speed using the Speed Near Obstacles slider
- Maximum controller speed settings apply when no structure is present
- Stop at Structure is active during manual flight, including when paused during a 3D Scan



**CAUTION:** *Flying with Close, Minimal or Disabled settings greatly increases the risk of collision. Minimal or Disabled settings are used to navigate tight spaces and should only be used if you are an experienced pilot. Skydio recommends turning down controller throttle, roll, and pitch sensitivity to the lowest setting and proceeding at a maximum speed of 2 mph (1 m/s).*

## Return

Configure your standard return behaviors as well as how Skydio X10D will return if connection is lost.

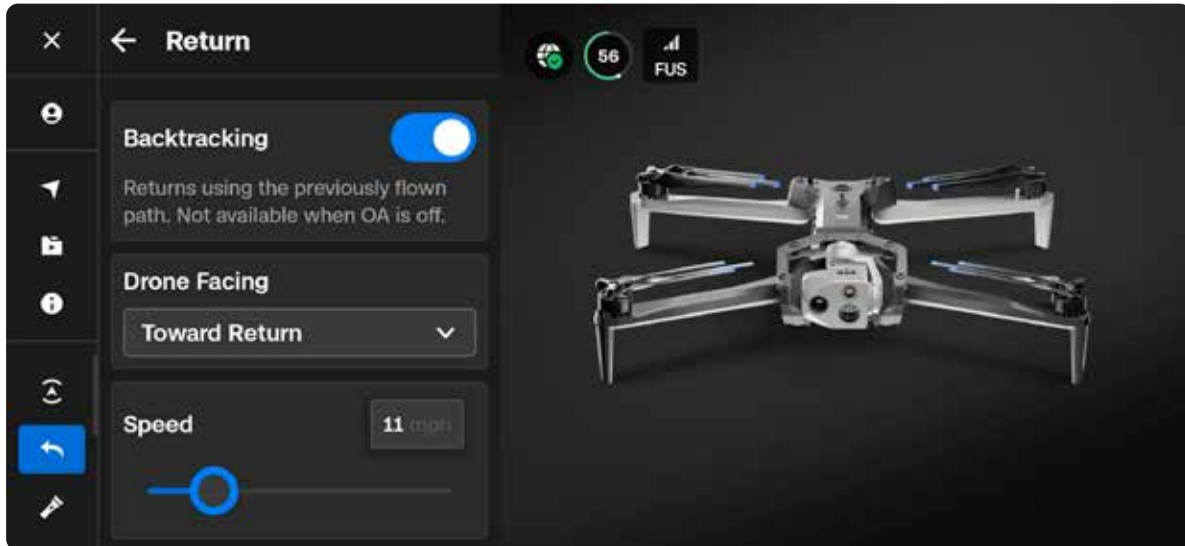

**WARNING:** Before flying, ensure you have set your Lost Connection Return Behaviors. This is a critical step that ensures your drone returns safely and lands in an accessible location.

## Return

### Backtracking

Return using previously flown path. Obstacle Avoidance must be on to use this feature.

### Height Behavior

Customize the altitude behavior of Skydio X10D when returning.

Use Return Height to set the altitude at which the drone will ascend to before returning.

Absolute means your drone will ascend to the specified Return Height above the Launch Point before returning

- For example, if the Return Height is 32 ft and the drone is at 20 ft at the time the return is commanded, Skydio will ascend 12 ft before returning

Relative means your drone will ascend to the specified Return Height above the current position before returning

- For example, if the Return Height is 32 ft and the drone is at 20 ft at the time the return is commanded, Skydio will ascend 32 ft and then return at a height of 52 ft

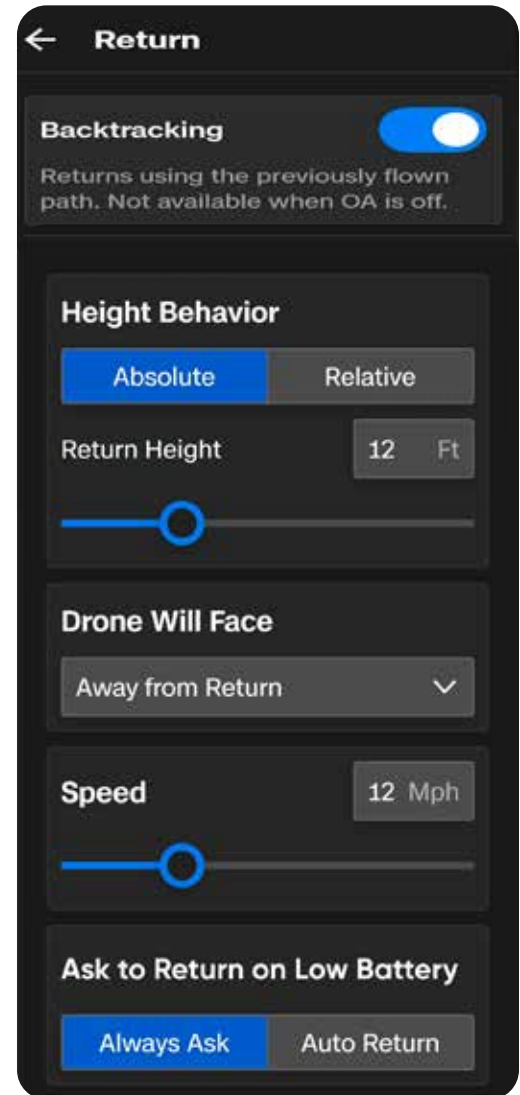

**Drone Will Face:** Set Skydio X10D to either look toward or away from the return destination while flying.

**Speed:** Set the speed at which Skydio X10D returns

- GPS return: 1 - 45 mph (0.5 - 20 m/s)

**Ask to Return on Low Battery:** When the battery is only sufficient to return and land, choose between a prompt or an automatic return.

- Always Ask (default) means you will be asked to select the return location each time the battery level is low.
- Auto Return means the drone will automatically return to either the Launch Point or the Home Point (if set) when the battery is low.

# Automatic Dependent Surveillance - Broadcast (ADS-B)

**Step 1** - Select the Global Setting menu, the Display tab, and Air Traffic

Use the adjustable alerting range to customize the detection sensitivity, where V is the vertical distance from the drone before the alert is triggered, and H is the horizontal distance. The default range is set to Small.

- Small - H: 0.5 NM; V: +/- 500 ft (152 m)
- Medium - H: 1 NM; V: +/- 500 ft (152 m)
- Large - H: 1.5 NM; V: +/- 500 ft (152 m)

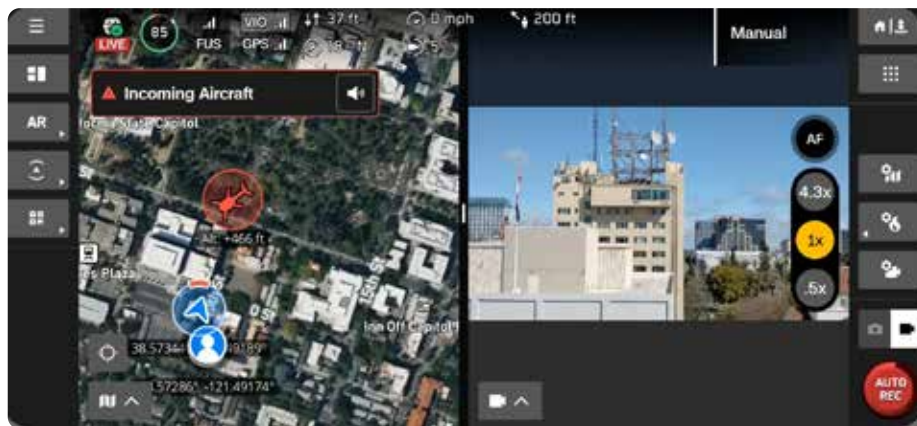

When an aircraft enters your alert range, its icon will turn red and you will hear an audible alert through the controller speakers.

- Aircraft icon – Displays either a fixed-wing aircraft or rotorcraft, with the altitude relative to your drone. Select this icon to view more flight details such as vertical/horizontal speed, and ground distance.
- Visual notification – A message alert appears in the top right of the screen and displays Incoming Aircraft
- Audible alert (off by default) - When an aircraft enters your alert radius, the X10 Controller will play an audible alert. Select the speaker icon in the message box to mute the alert.

# Lost Connection

If connection is lost, Skydio X10D will default to the **Lost Connection** settings. Select between **Return** and **Hover** upon lost connection.

## Return

**Wait Before Return** - set the amount of time you want Skydio X10D to wait before it initiates a return flight, allowing time to reconnect

**Land After Return** - when enabled, your drone will return, hover for a specified amount of time, then land.

**Wait Before Land** - the amount of time between 0 to 300 seconds (default is 240 seconds) that you want your drone to wait above the landing location before landing. This setting is only enabled when Land After Return is toggled on.

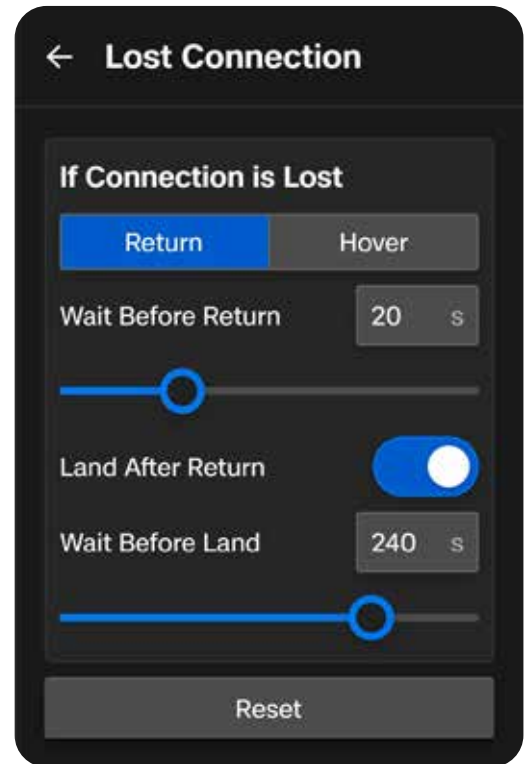

## Hover

**Land After Hover** - when enabled, Skydio X10D will hover for a specified amount of time, then use visual navigation to find a safe area to land.

**Wait Before Land** - the amount of time between 0 to 300 seconds (default is 240 seconds) that you want your drone to wait before landing. This setting is only enabled when Land After Hover is toggled on.



Skydio X10D will continue hovering as it tries to regain connection. If it fails to reconnect and reaches low battery:

- If you have an automatic return set, your drone will return to either the Launch Point or Home Point (if set)
- If you do not have an automatic return set, your drone will use visual navigation to find a safe area to land
- If VIO is degraded (flying in Low Light without NightSense), your drone will be unable to use visual navigation and will descend vertically and land

## Attitude Mode Return

- Set the return altitude AGL taking the terrain into consideration
- Calibrate the magnetometer
- A compass will display on the fly screen the return heading
- Manually adjust the compass to set return heading

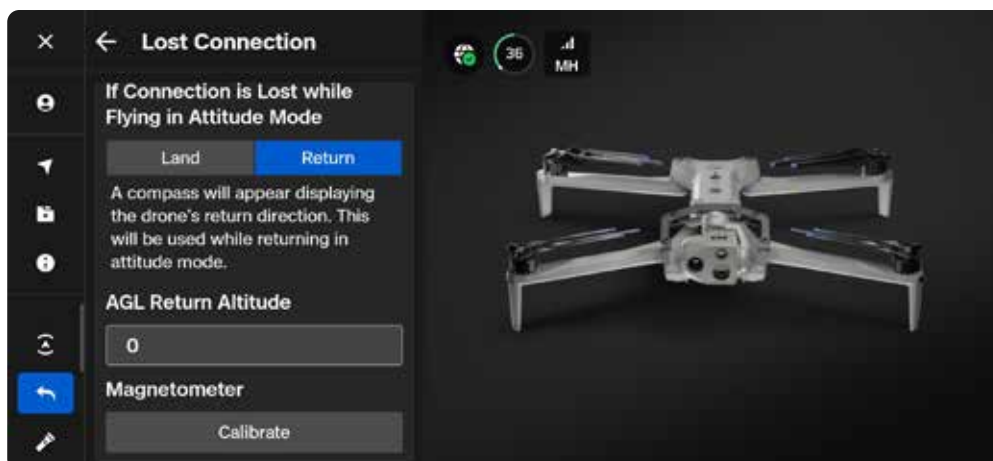

# Lighting

Skydio X10 navigation lights (RGB) are enabled by default. To disable these lights, or enable strobe or infrared lights, navigate to the Lighting menu under Global Settings.

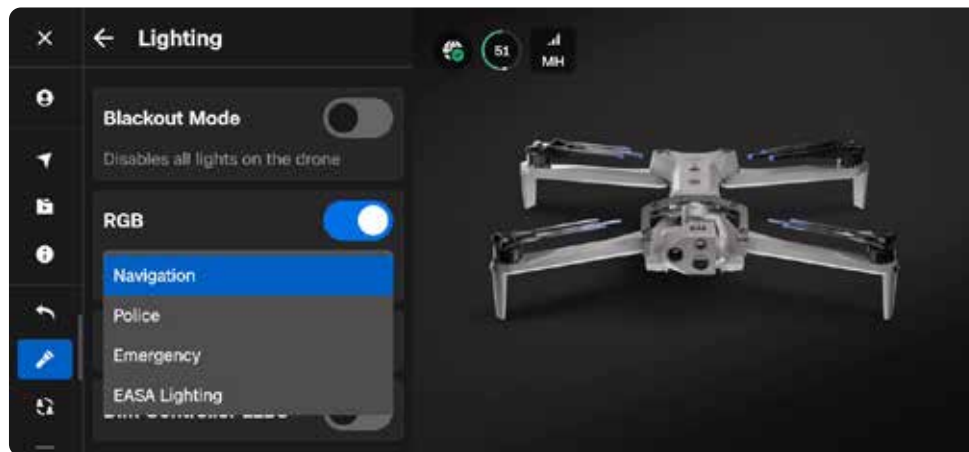

**Blackout Mode** - Enabling Blackout Mode will turn off all visible and IR light sources on the vehicle, disable the light toggles, and dim the controller lights. Setting Blackout Mode will persist across flights and power cycles.

RGB: Three options will appear in the drop-down menu:

- Navigation (default)
- Police
- Emergency

**RGB** - When enabled, the lights on the end of the arms will appear red and green while flying. When the drone is powered on and grounded, the lights will appear blue.

**Police** - When enabled, the front and back RGB lights on the drone will flash red and blue and alternate colors between the right and left arms. Red: Front left, back right/Blue: Front right, back left.

**Emergency** - When enabled, the front and back RGB lights on the drone will flash red and white and alternate colors between the right and left arms. Red: Front left, back right/White: Front right, back left.

**Strobe** - Enable to visually track the drone in low-light conditions. Skydio X10D strobe lights meet the FAA requirement of being visible at a distance of (3 4.8 km) statute miles.

**Infrared** - Cannot be seen by the naked eye. These broadcast an IR light that can only be detected with an infrared lens. Assists with navigation in low-light.

**European Aviation Safety Agency (EASA) Lighting** - display a red front light, a white rear light, and periodically flashing green lights visible from all directions.

## Sharing

The Sharing menu allows you to stream using ATAK or RTSP.

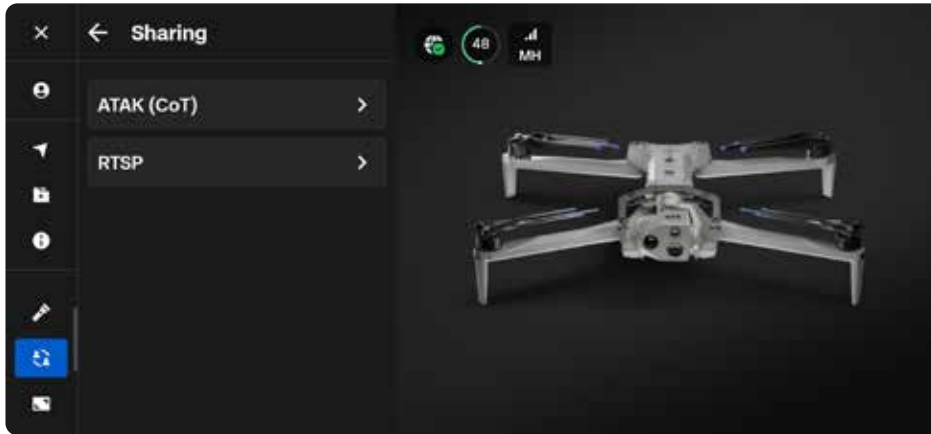

### ATAK

The integration of the Skydio X10D Controller and the Android Team Awareness Kit (ATAK) app allows you to broadcast the controller and vehicle telemetry data, and Real-Time Streaming Protocol (RTSP) video feed of the Skydio X10D to other nodes in the ATAK network.

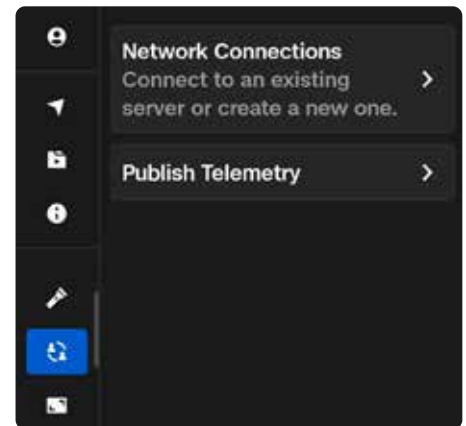

### USB Networking

**USB-C Mode:** Selecting the USB Hub option from the segmented controller will set the USB port to be compatible with third-party hubs.

**Static IP Addressing:** Allows users to manually configure static IP settings for Ethernet connections made through the controller's USB-C port. It introduces a simple workflow to assign an IP address, subnet mask, gateway, and DNS when no DHCP server is available. By supporting static configuration, the controller can integrate with a wider range of tactical radios and networks that disable DHCP for security or policy without engineering assistance.



**INFO:** Skydio X10D does not support the operators visualization of ATAK. However, it can transmit telemetry and RTSP feeds to connected ATAK nodes via the configured server. For more information about setting up ATAK, visit [How to set up ATAK with the Skydio X10D Controller](#).

## Radio

Use this menu to configure your radio settings. Toggle Dynamic Channel Switching on or off and manually select your frequency.

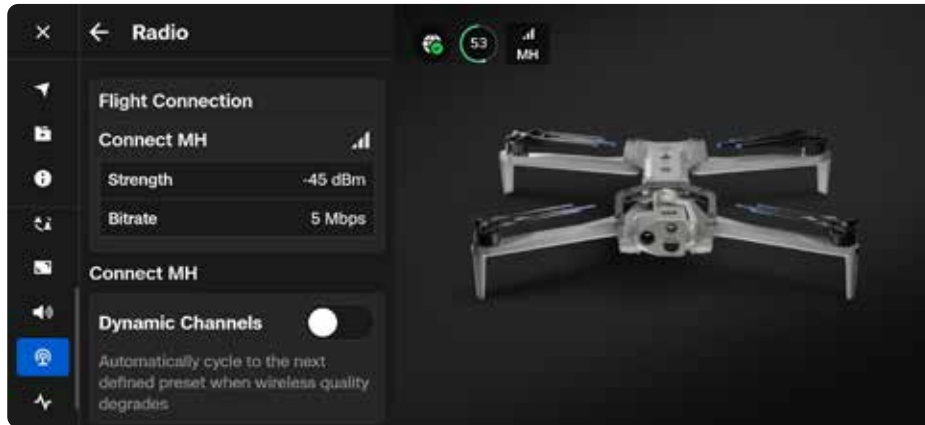

### Dynamic Channel Switching

Cycle through six preset frequencies to automatically find the cleanest channel, ensuring stable and reliable flight.

Step 1 - Select Global Setting, the Information menu, and the Radio tab

- Select the power, channel, and band for each preset
- Select Finish

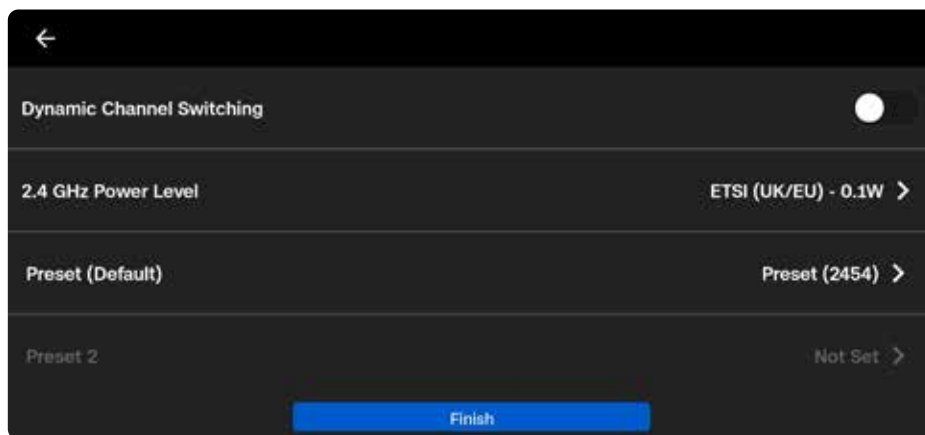

**NOTE:** The frequency selection options are specified as center frequencies for an 8 MHz channel ( $\pm 4$  MHz from center). Select the value that matches the center assigned by your frequency office; if given band edges, choose their midpoint. Power levels are EIRP (not conducted transmitter output).

## Display

Customize your Flight Screen display, including telemetry metrics, display brightness, unit type, depth style, enable screen recording, and gridlines:

- Centerpoint - Displays a crosshair in the center of the screen to align subjects
- Grid - Adds a rule of thirds overlay for balanced framing
- Diagonal - Displays two intersecting diagonal lines from opposite corners, aiding in angular alignment

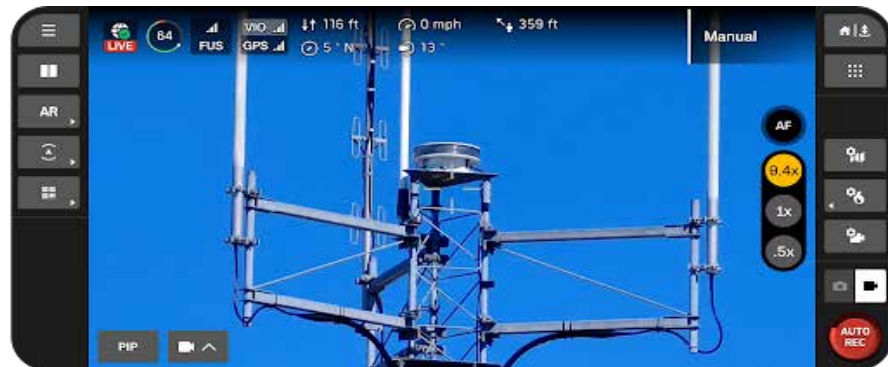
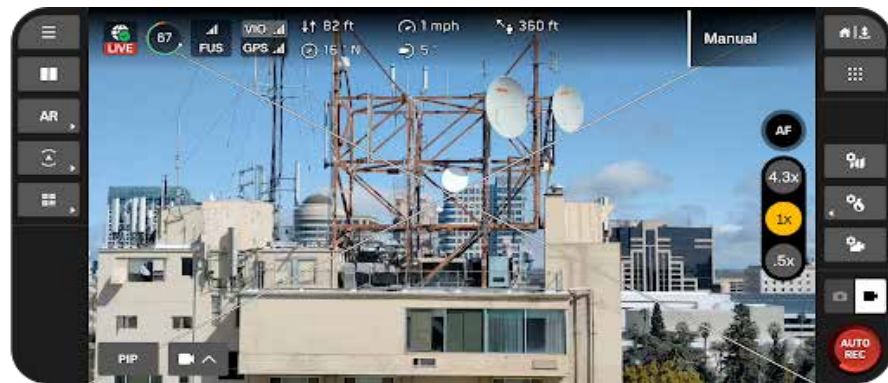
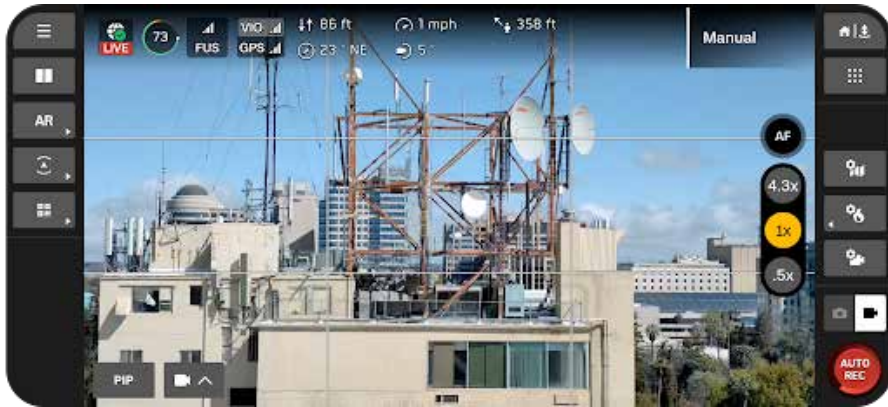

# Skydio Flight Deck

## Telemetry

Customize the telemetry metrics you want to display while flying. Select the blue check mark to enable or disable the corresponding telemetry information. Select up to 6 items to display on your telemetry bar:

- Altitude
- Distance from Launch
- Heading
- Ground Speed
- Gimbal Pitch
- Distance from Controller
- Radio Frequency
- GPS Satellite Count
- Obstacle Avoidance
- Battery Temperature
- Time Elapsed
- Time until Shutdown
- Wind Speed & Direction

## Display Brightness

Adjust the brightness of your X10D Controller screen.

## Units

Choose between Imperial or Metric units.

## Depth Style

Only applies if you have enabled Depth View within the AR Quick Actions (located on the left side of the Flight Screen).

Select **Solid** or **Outline** when displaying visual information about what obstacles the drone sees.

- Solid displays boxes filled with color
- Outline displays framed or unfilled boxes

The AR Quick Actions button on the Flight Screen cycles between the distances from objects at which the visual information will start showing on screen.

- Off
- 6 ft (2 m)
- 13 ft (4 m)

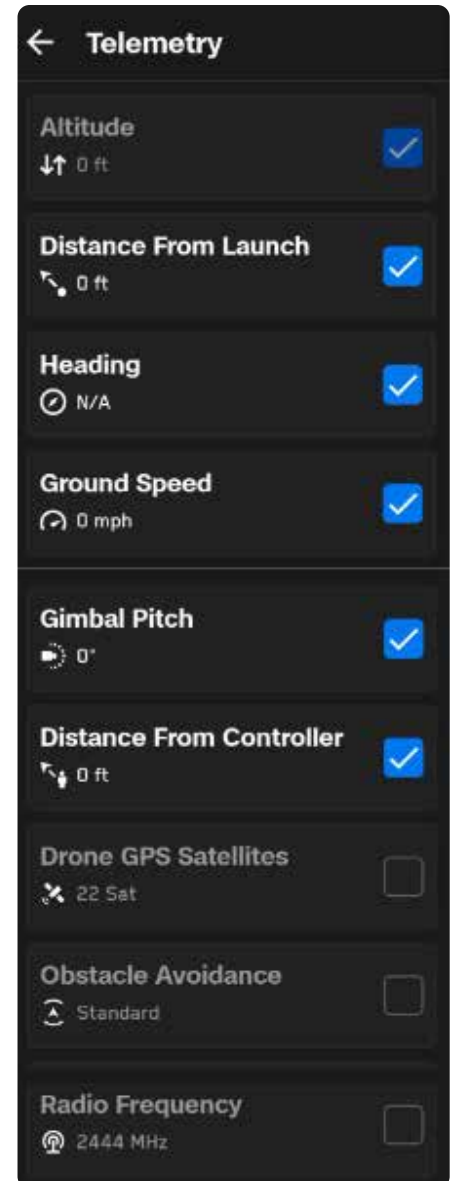

## Display Layouts

While flying, you have the option to use a Single, Split or Grid layout to set the number of streams that appear while flying. Available feeds include:

- Color
- Thermal
- Map

### Single Layout

Displays one stream at a time.

In this layout, you will see a Picture-in-Picture (PiP) in the bottom left of the screen.

- Minimize using the two arrows in the top right
- Use the buttons on the bottom to select whether the Color, Thermal or Map feed displays in the PiP



# Skydio Flight Deck

## Split Layout

Choose two streams to display. Drag the middle handlebar to resize streams.

The primary feed displays on the right.

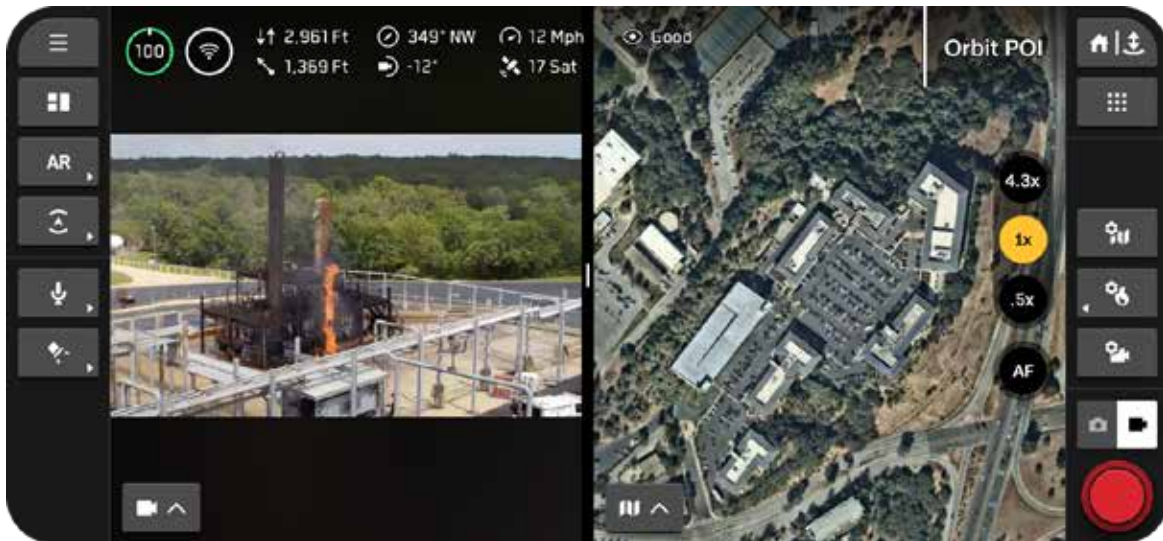

## Grid Layout

Choose three streams to display. Press and drag the middle handlebar to resize streams.

The primary feed displays on the right.



## Customizing Display Layout

### Step 1 - Select the Display Layout icon in the left sidebar

Use this button to cycle through the various layout options. The icon reflects the next layout in the queue rather than the layout you are currently using.

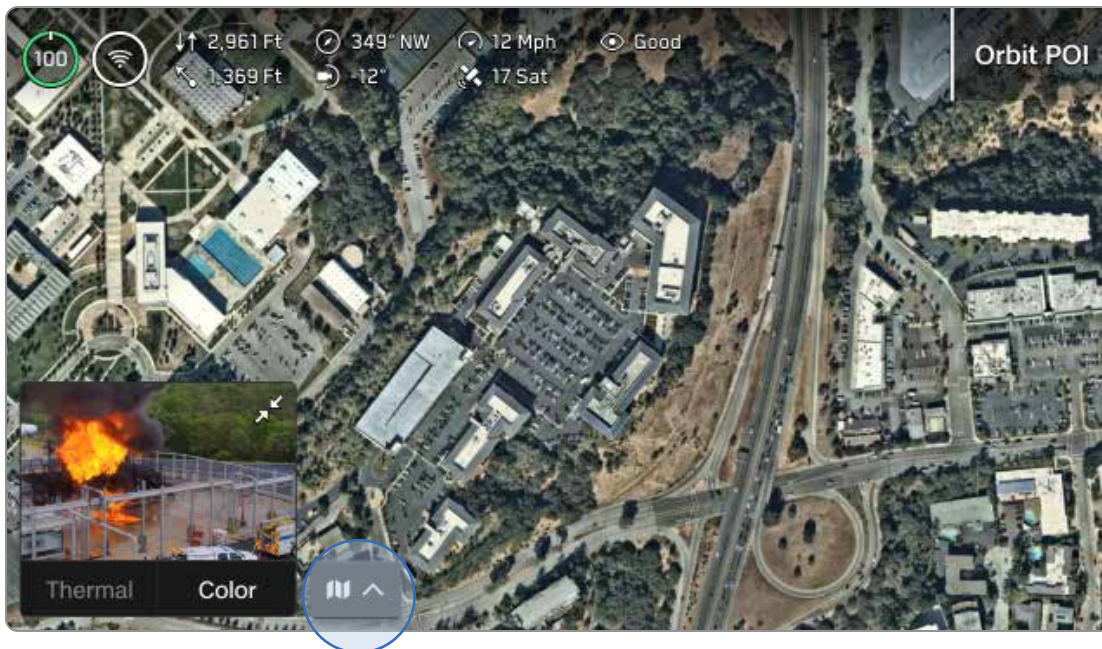
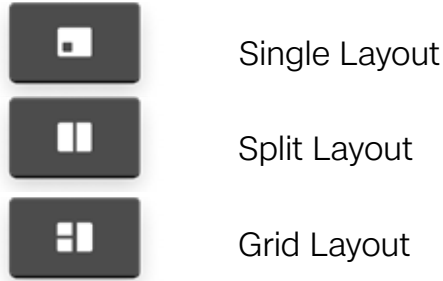

# Skydio Flight Deck

## Step 2 - Use the View Selector to select which feeds display

A menu will appear with the stream options. Drag the middle handlebar to resize streams.

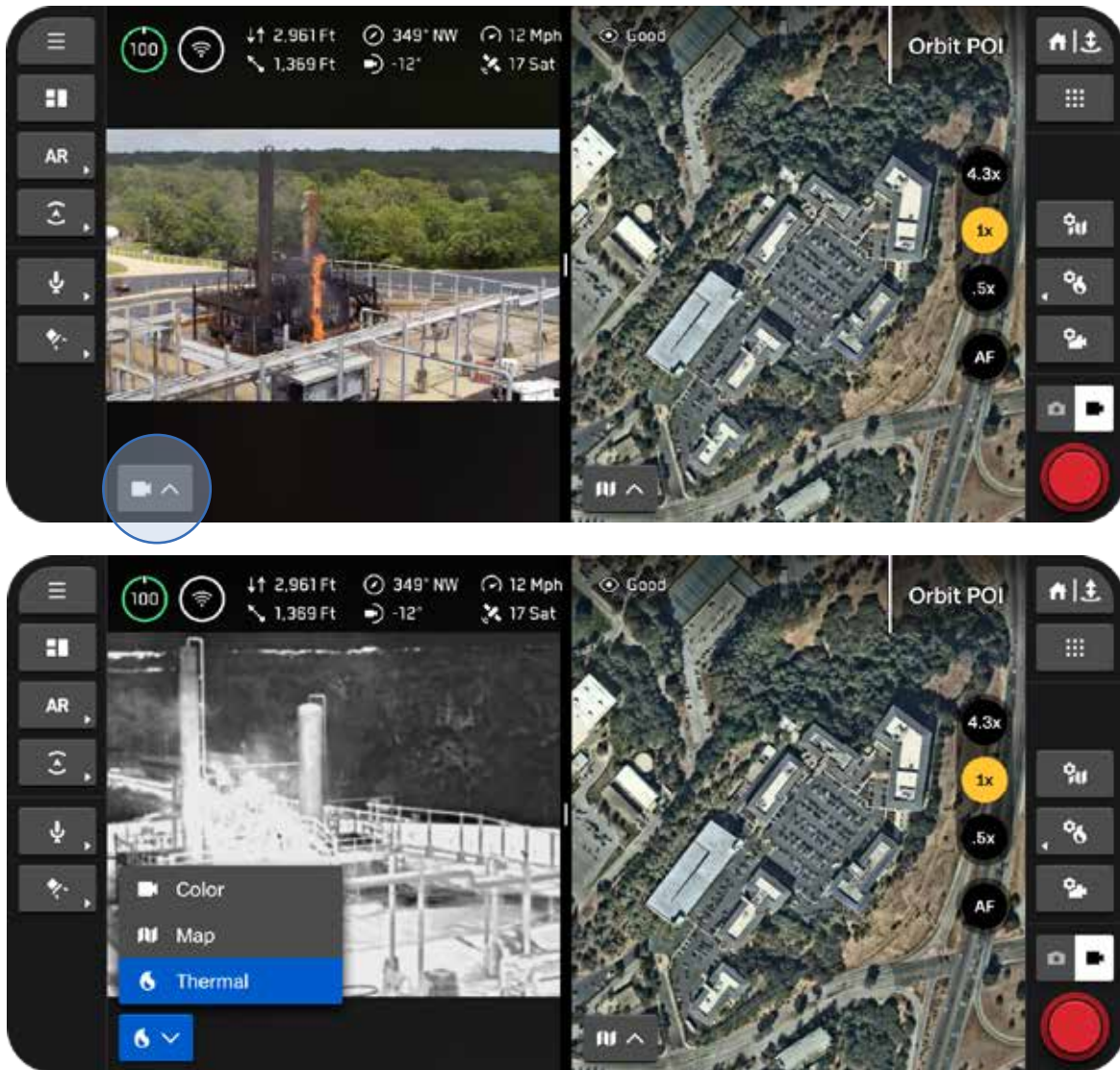

# Sound

Use the new sound menu to set the volume for audible ADS-B, low battery alert, and shutter sound notifications. The default volume for sound is set to 0 (silent). Use the slider to adjust the volume.

- Controller speaker volume
- Drone speaker volume
- Notification volume
- Camera shutter sounds

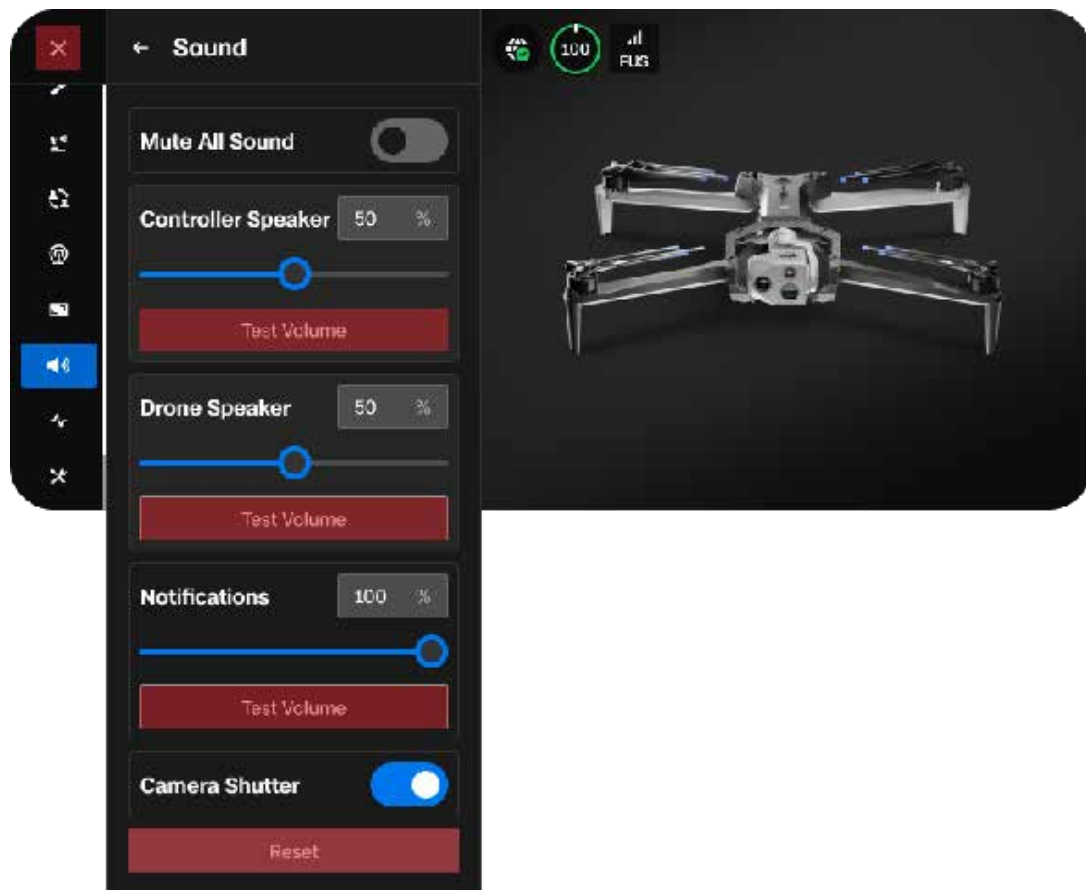

# System Status

Provides a comprehensive overview of the system at a glance.

Displays:

- Vehicle and channel
- Flight connection and radio
- Controller connection
- GPS strength
- ATAK server
- Live Streaming

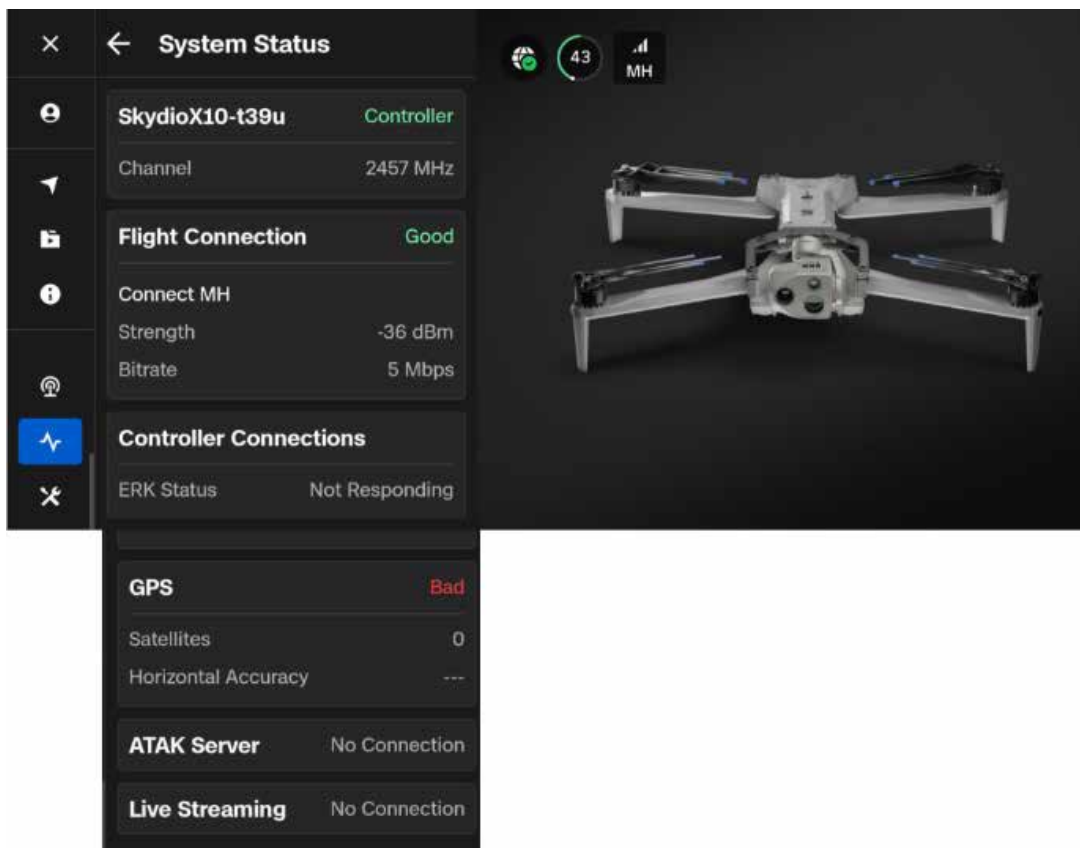

# Quick Actions

The left sidebar of your Flight Screen contains a variety of Quick Action menus. With Quick Actions, you have the ability to quickly **toggle** a setting or **cycle** through setting options.

### Toggle

Full green bar indicates a setting is ON.



### Cycle

A menu will pop out and label the current setting. The green bars indicate the number of available settings.

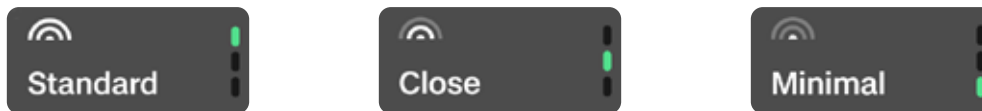

## Augmented Reality (AR) Quick Actions

Enable to visually display where Skydio X10D detects obstacles in the environment. Appears as either solid or outlined augmented reality (AR) boxes, depending on your selection within the **Display** menu.

Use the **AR Quick Action** button to cycle between the distances from which obstacles are rendered on the screen. Objects that are closer appear red.

- Off
- 0 - 6 ft (0 - 2 m)
- 0 - 13 ft (0 - 4 m)

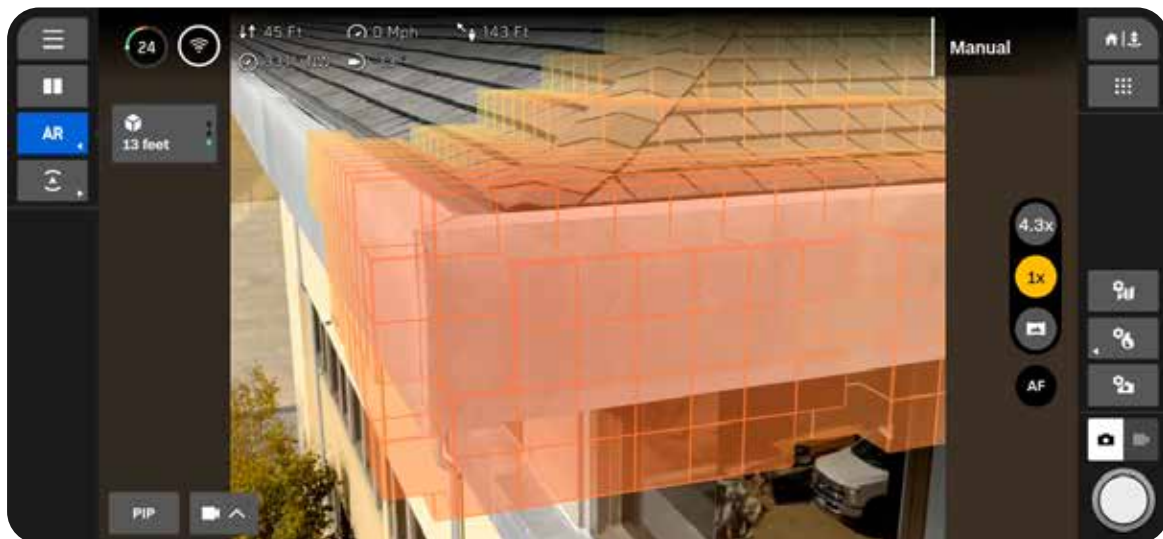
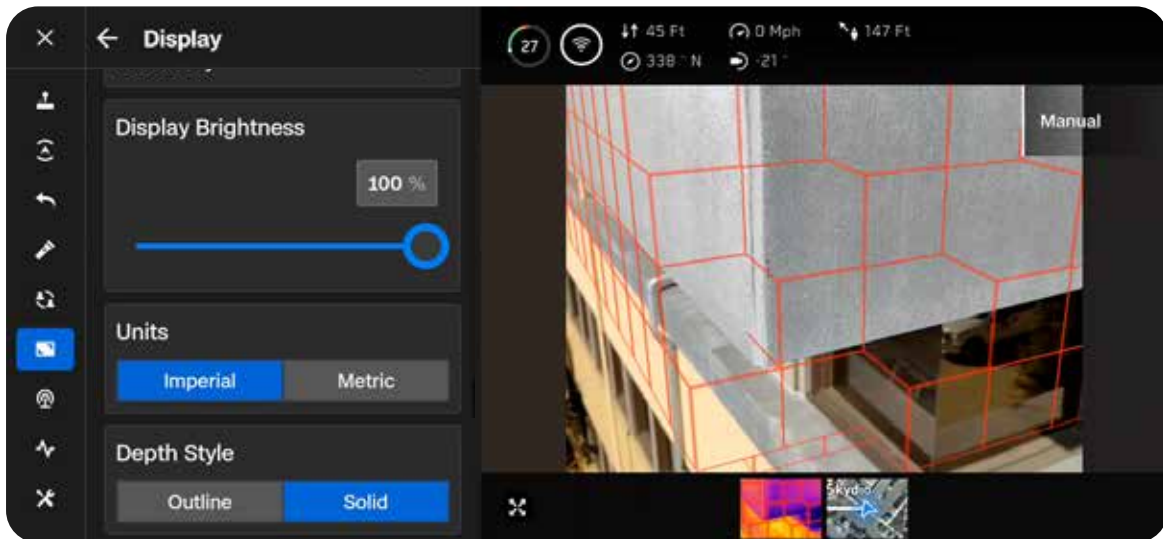

## Obstacle Avoidance Quick Actions

Quickly cycle through the three obstacle avoidance settings, available in the **Sensing** menu.

A yellow border appears when in Close or Minimal obstacle avoidance mode.



# Inflight Map

View your current location, search, set a Home Point, and configure map settings.

- The location of Skydio X10D, the controller, Launch Point, and Home Point (if set) are indicated on the map
- Press and hold on a location to set a **Home Point**



Skydio X10D



Controller



Launch Point



Home Point

Adjust your map settings during flight using the **Map Settings** icon.

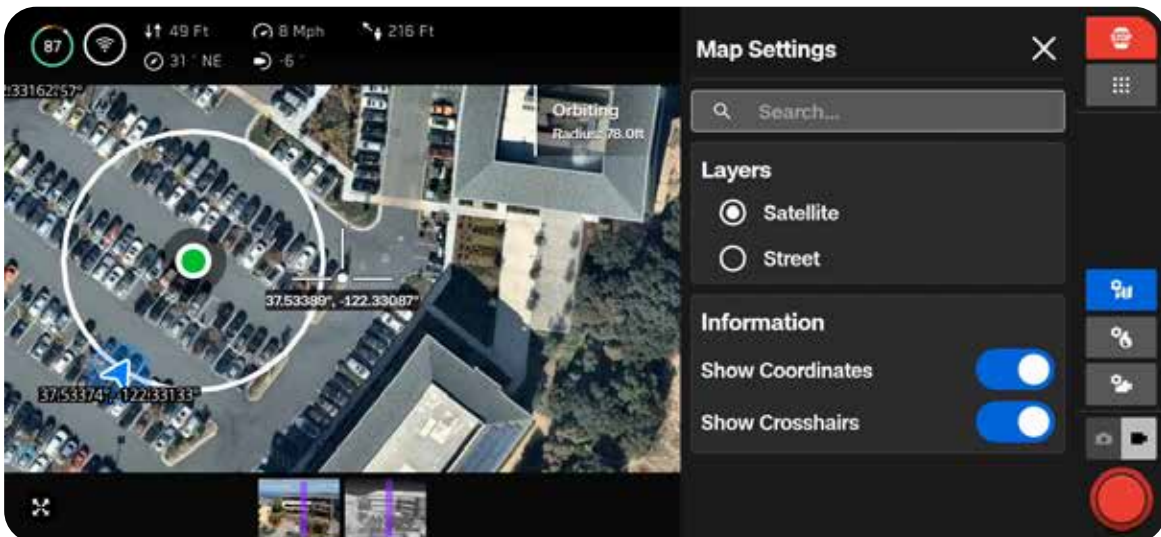
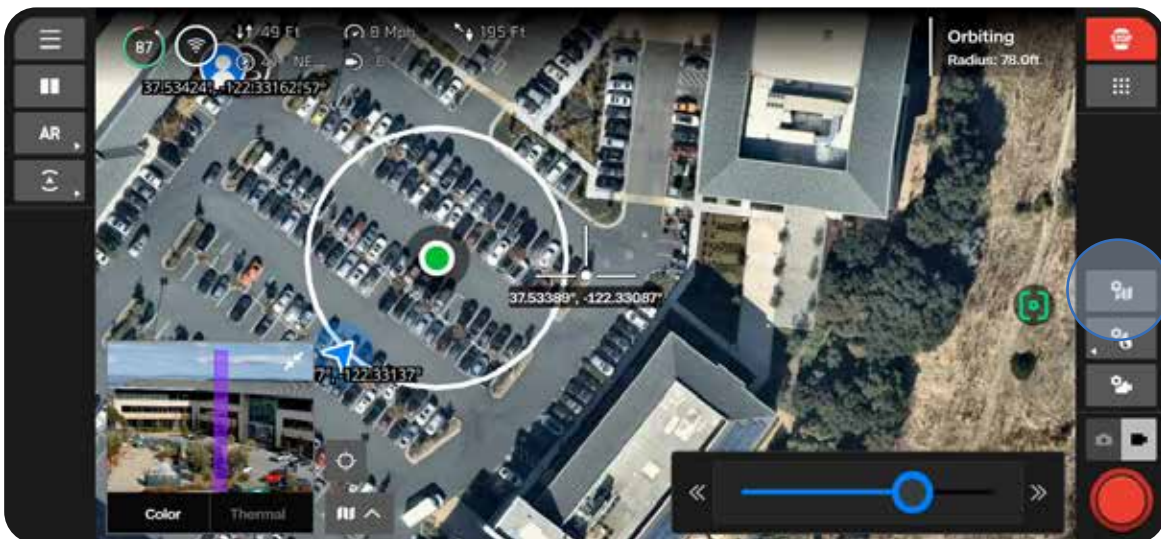



# Camera Settings

Learn how to adjust camera and video settings such as zoom, exposure, ISO, and resolution.

## **This section covers**

---

Overview

---

Capture Settings (Photo and Video)

---

Focus and Exposure

---

Zoom Settings (Photo and Video)

---

Shutter Indicators

---

Photo Settings

---

Video Settings

---

VT300-L Flashlight

---

# Overview

When your drone captures a photo or video, it will save one image file with the color camera. Two files will save if you have JPG and DNG enabled. If you would like Skydio X10D to also capture an image file with the thermal camera, enable **Thermal Capture** within the **Thermal Settings**.

Use **Camera Mode** on the right sidebar to switch between photo or video. Skydio X10D can capture photos or videos but not both at the same time. Your color and thermal cameras will always be in the same Camera Mode.

Access your photos and videos using the **Media** menu located in **Global Settings**.



Photo enabled



Video enabled

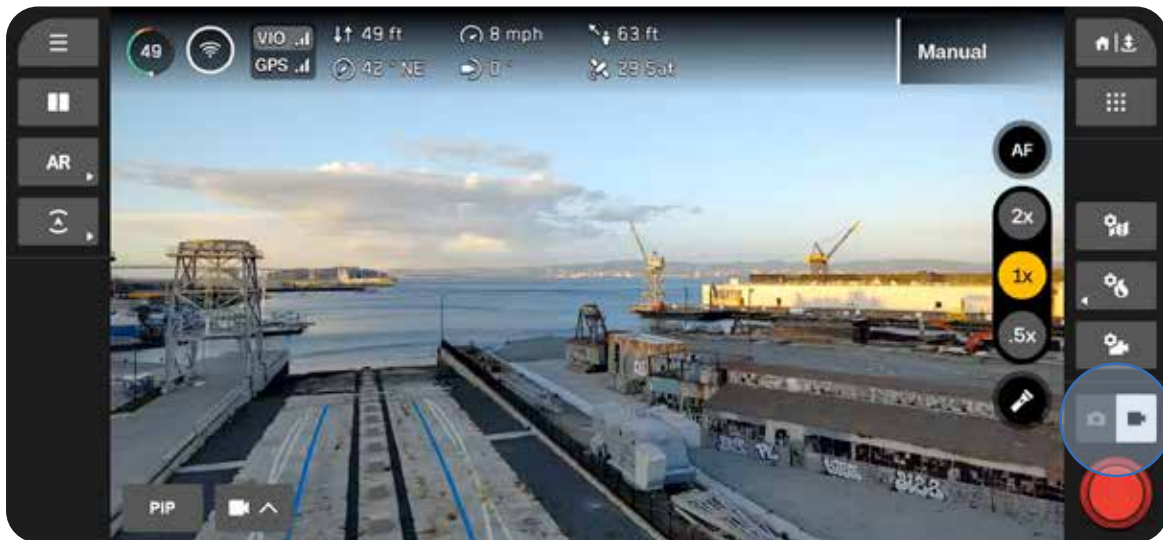

**NOTE:** Photo and Video mode settings are independent of each other and persist through mode changes, but not power cycles.

### Capture Settings (Photo and Video)

#### Brightness Exposure Value (EV)

Refers to the amount of light the camera allows in.

Negative numbers result in darker images (less exposure) while positive numbers result in brighter images (more exposure).

- Brightness is set to Auto by default

#### White Balance

Balances the color temperature in your photo. If the whites in your picture are too orange, for example, adding the opposite color (blue) will balance them out.

Lower values result in a cooler (blues) image while higher values result in a warmer (yellows) image.

- Auto (default) means Skydio X10D will automatically adjust the White Balance for its environment

#### ISO

Brightens or darkens your photo. When in low-light conditions, raising the ISO value will brighten the image, however you may see some graininess.

- Auto means Skydio X10D will automatically adjust the ISO for its environment

#### Shutter

Refers to the length of time a photo is exposed.

Slower shutter speed means greater exposure, while faster shutter speed means less exposure.

- Auto means Skydio X10D will automatically adjust the Shutter speed based on the available light

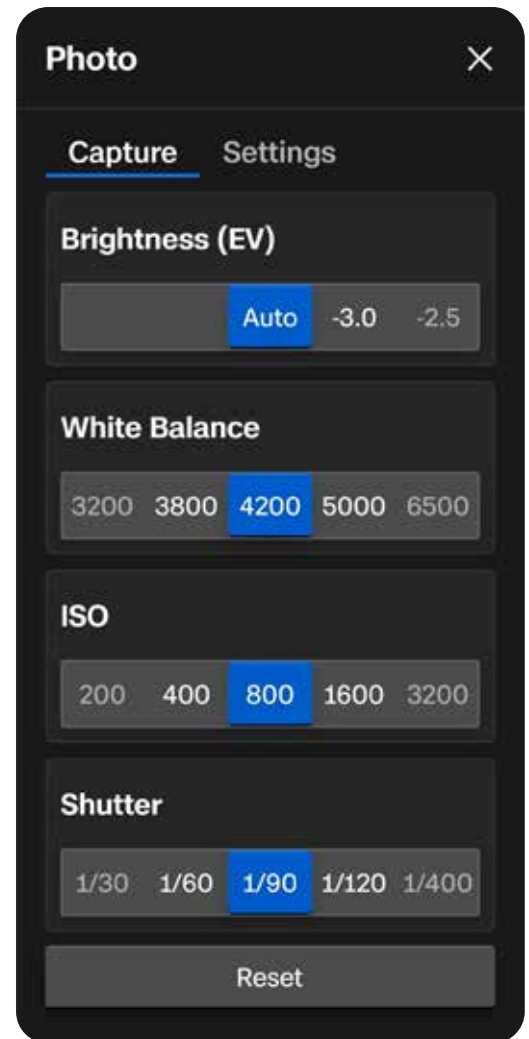

## Focus and Exposure

To view the various focus options, select the Focus Control button on the right side of the Flight Screen.

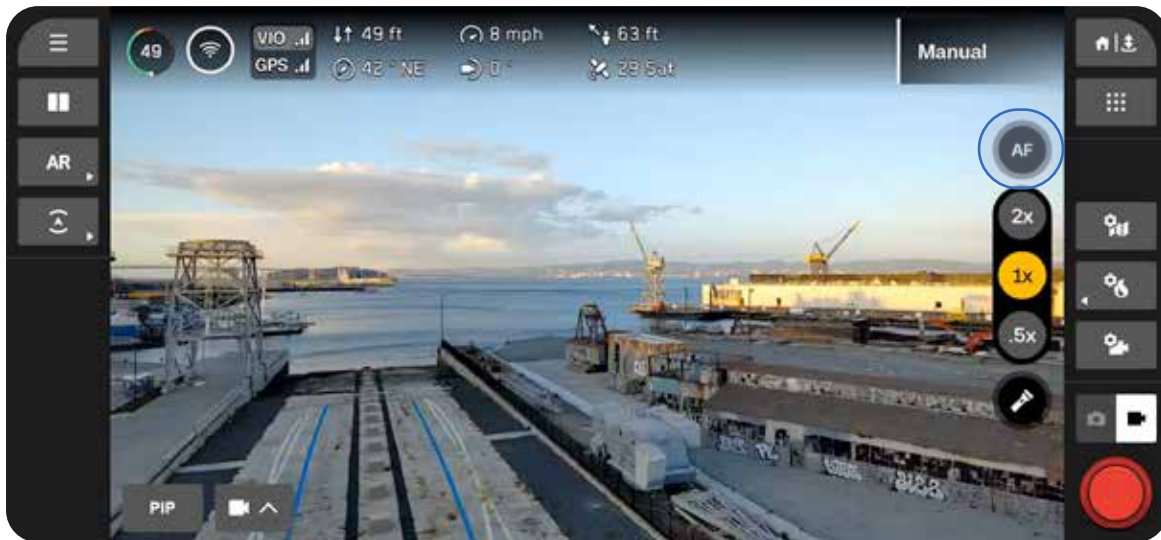

### AutoFocus (AF)

By default, your camera will be set to automatically adjust focus and exposure. In this focus mode, focus will generally prioritize objects in the center of the screen.



### Manual Focus (MF)

After selecting the Manual Focus icon, two more button options will appear.



- Use the image of the mountain to focus on objects further away
- Use the image of the flower to focus on objects that are closer

### Tap to Focus

Touch anywhere on the screen to focus on an area of interest, or select the icon to center. The Focus Indicator will turn green once the image is sharp and clear. a padlock icon will appear which can be selected to lock focal point and exposure. When focal point and exposure lock is used, the icon will remain on the screen until another location is selected, or the padlock de-selected.



### Zoom Settings (Photo and Video)

To zoom in digitally, place your finger on the right controller wheel and push it to the left. Customize this using Input Mapping (Flight Controls > Controls).

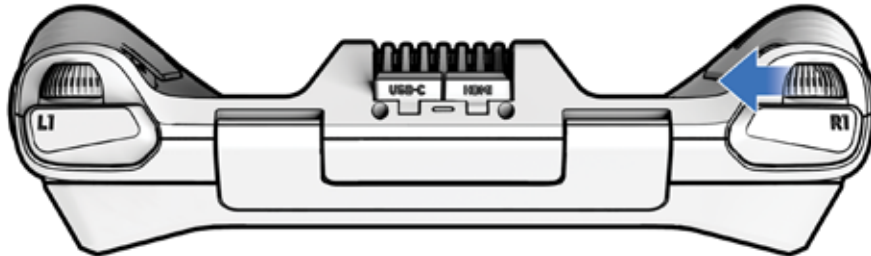

Quickly snap to a zoom level using the Zoom buttons on the right side of the screen.

#### VT300-Z Sensor

- 4.3x - transitions between narrow and telephoto lens, 128x max system zoom
- 1x - default zoom level of narrow lens
- .5x - Surround Vision

#### VT300-L Sensor

- 2x - transitions between wide and narrow lens, 64x max system zoom
- 1x - default zoom level of wide lens
- .5x - Surround Vision



**NOTE:** Images and videos taken while zoomed in will be saved at that zoom level.

# Camera Settings

## Surround Vision

Surround Vision uses Skydio X10D navigation cameras to generate an ultra-wide view of your environment for situational awareness.



**NOTE:** Photos and videos captured when in Surround Vision will be saved at 1x zoom.



## Thermal Zoom

The thermal camera will zoom up to 16x, but you may continue to zoom using the color camera. If any Tools are enabled, such as Region of Interest, they will dynamically adjust to fit the screen as you zoom.

## Shutter Indicators

The Shutter is located in the bottom right of the Flight Screen and indicates the current state of Photo or Video mode.

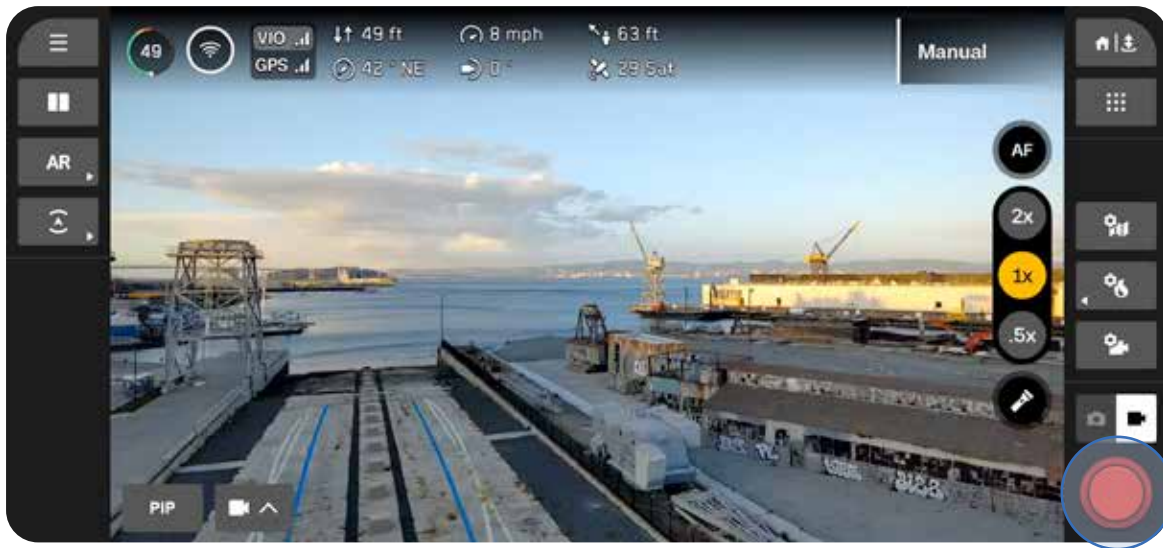

### Photo

Ready for Capture



Pressed



Disabled



Interval



### Video

Manual Record



Manual Record (Pressed)



Recording



Recording (Pressed)



Auto Recording



Auto Recording (Paused)



## Photo Settings

### File Type

Choose whether you want Skydio to capture JPG images only, or both JPG and DNG files.

- **JPG** - Digital image format containing compressed image data.
- **DNG** - RAW image format file, meaning it is not compressed and retains all original photo data. A DNG file is larger than a JPG file since it stores image data.

### Resolution

Refers to the resolution of captured image. Measured in megapixels.

- **Full** - Images are captured at the highest quality, providing more detail and clarity.
- **1/4** - Images are captured at one-fourth of the full resolution, resulting in smaller file sizes. Best for conserving storage space or transmitting images faster.

### Camera Mode

- **Standard** - Designed for typical, everyday lighting conditions. Provides a balanced, standard level of exposure, image processing, and contrast.
- **Low Light** - Designed for environments with dim lighting, such as indoors or evening. Settings are adjusted to capture more light, reduce noise, and improve visibility. Only available with 1/4 Resolution.
- **HDR (High Dynamic Range)** - Combines multiple exposures into one image to capture greater detail in both bright and dark areas of a scene. Only available with 1/4 Resolution.

### Interval

When enabled, Skydio X10D will continuously capture photos at the specified time interval until the setting is disabled or the flight ends.

### Camera Shutter Capture Sound

- Toggle on or off

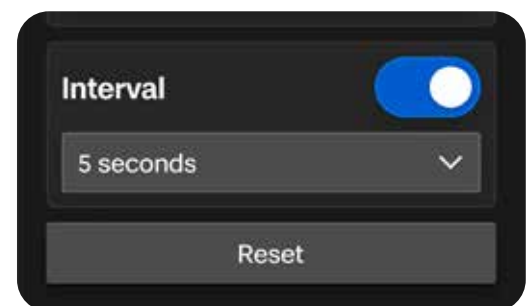

### Video Settings

#### Auto Start Recording

When enabled, Skydio X10D will record video automatically.

When disabled, tap the on-screen Shutter button or on the controller (R1 button) to start/stop video recording.

#### File Type

Select between H.264 and H.265 compression formats, depending on your preferences for video quality, file size, and playback compatibility.

- **H.264** - Provides manageable file sizes without sacrificing video quality. Recommended for standard video recording, and compatible with most devices and video editing software.
- **H.265** - Ideal for high-quality video capture and maintains efficient compression.

#### Resolution

Select between 4K and Full HD, which refers to the amount of detail in your video. Measured in pixels.

- More pixels result in a high-resolution video
- Fewer pixels result in a lower resolution video



# Camera Settings

---

## Camera Mode

- **Standard** - Designed for typical, everyday lighting conditions. Provides a balanced, standard level of exposure, image processing, and contrast.
- **Low Light** - Designed for environments with dim lighting, such as indoors or evening. Settings are adjusted to capture more light, reduce noise, and improve visibility.
- **HDR** - Designed to capture environments with a wide range of brightness levels.

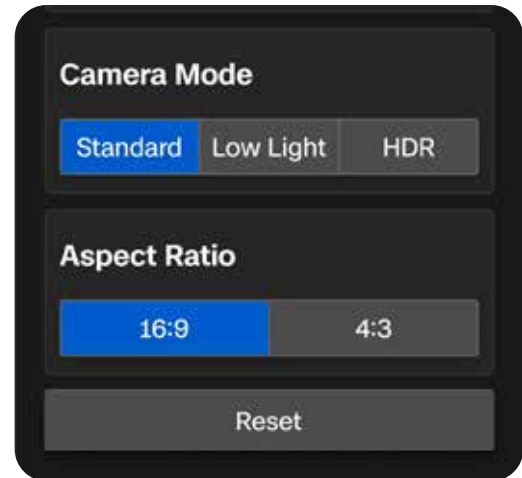

## Aspect Ratio

Sets the shape and framing of your video.

- **16:9** - Provides a wider, broader field of view.
- **4:3** - Provides greater FOV in the vertical axis, resulting in more square-shaped framing. Images are taller, as opposed to wider.

### VT300-L Sensor Package Flashlight

The VT300-L sensor package comes quipped with a flashlight, providing effective illumination up to 10 ft (3 m) and enabling inspections in low-light environments.

Select the on-screen flashlight icon to turn the flashlight on or off in flight.



**NOTE:** The flashlight can only be controlled during flight and will not be operational on the ground nor during launch and landing.



**WARNING:** When using the flashlight on the VT300-L sensor package, do not stare directly into the light at any range for any extended period of time.



**WARNING:** After prolonged use of the flashlight, your sensor package may be hot to the touch and could present a serious burn risk. After landing, wait for your sensor package to cool down before handling.



# Thermal Camera

The thermal camera with Skydio X10D includes a powerful suite of tools, such as radiometric capabilities, to assist you in a variety of use cases.

## **This section covers**

---

Accessing Thermal Options

---

Flat Field Correction (FFC)

---

Thermal Tools

---

Thermal Settings

---

Thermal Parameters

---

# Accessing Thermal Options

Quickly access your Thermal Tools and Settings using the quick action button located on the right side of the Flight Screen.

## Step 1 - Select Thermal Settings

Easily enable some settings using the quick actions that appear, or access the full menu.

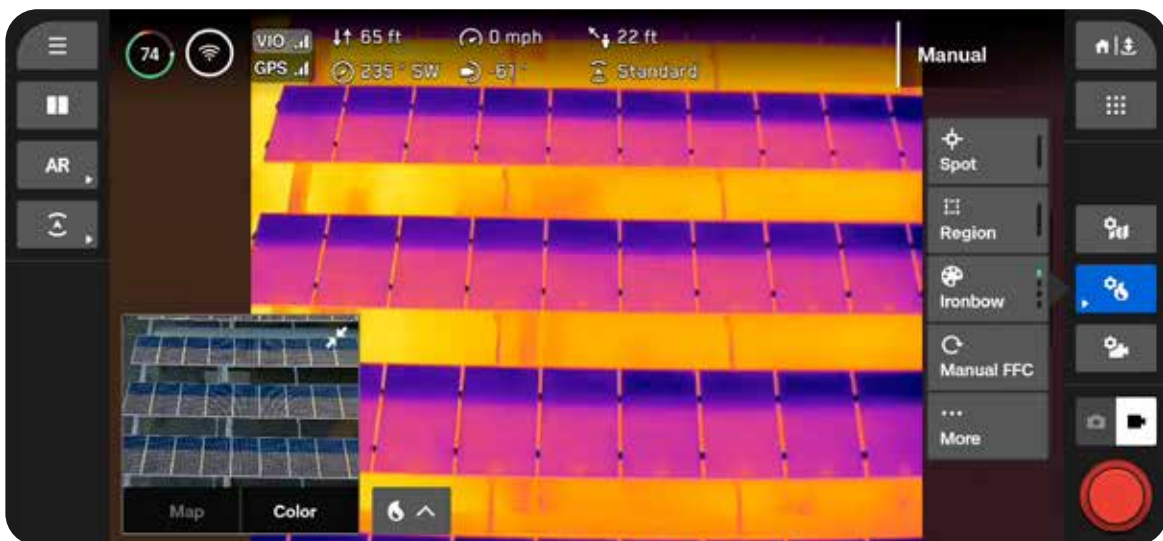
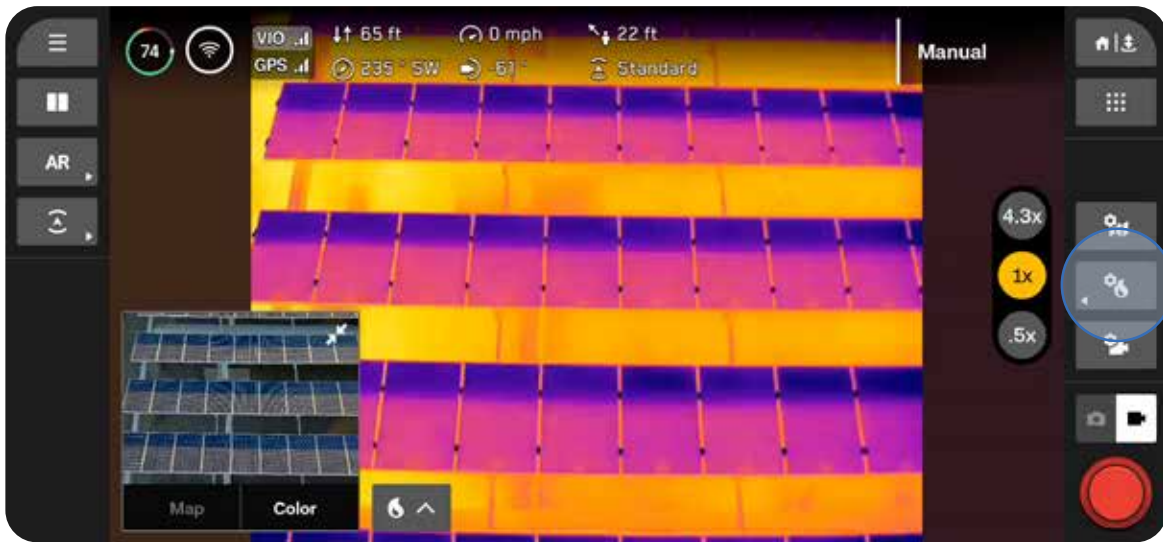

# Thermal Camera

## Step 2 - Select More

Use the tabs at the top to customize your Tools, Settings, and Parameters.

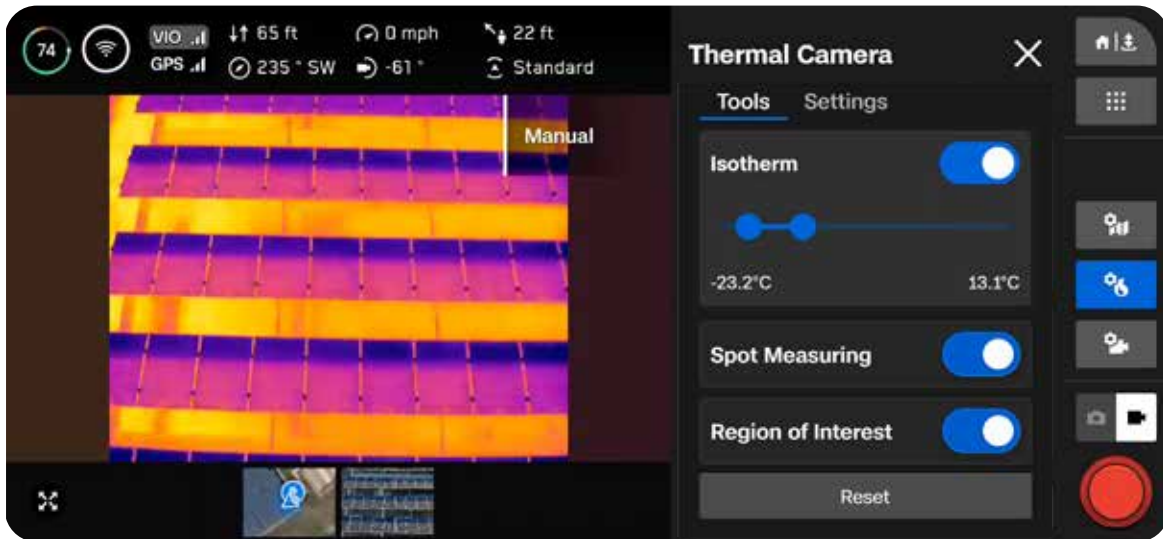
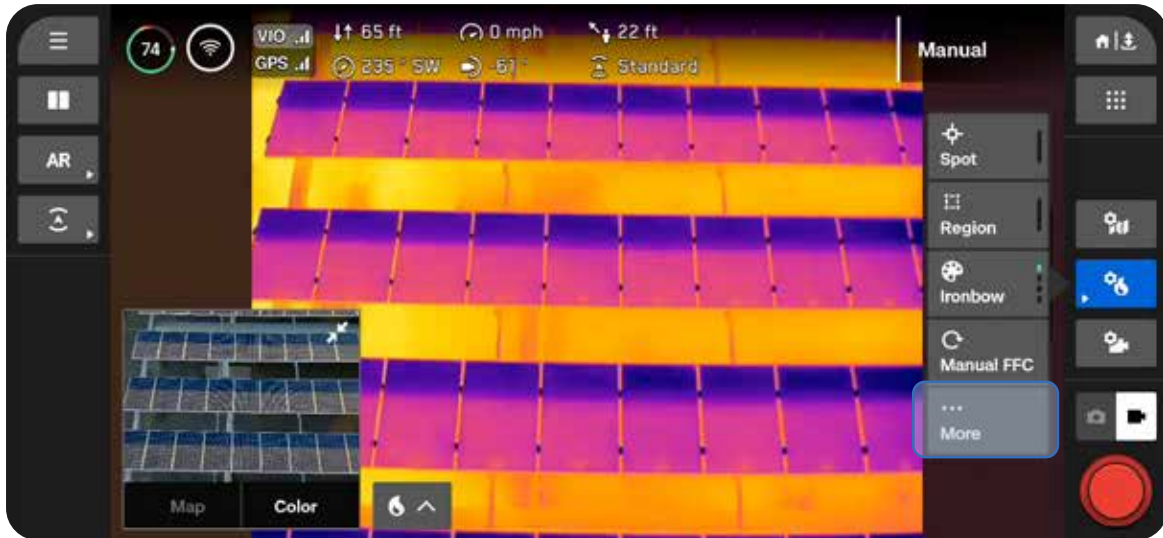

## Flat Field Correction (FFC)

Flat Field Correction (FFC) mitigates and compensates for errors that build up over time during the thermal camera operation. This is performed in the background automatically at lower zoom levels, however, you can use the Thermal Settings to manually perform FFC at any time.



**NOTE:** If you manually perform FFC, the actuation of the shutter may be noticeable on the image at higher zoom levels.

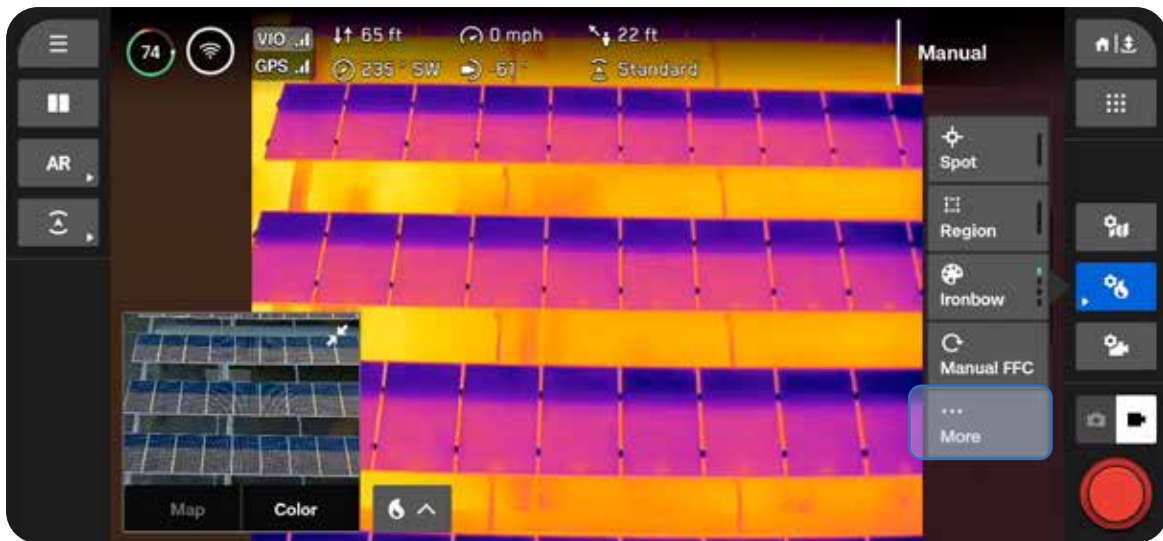

# Thermal Tools

### Isotherm

Allows you to set a range of temperatures to detect. Use this setting to omit unwanted data outside of the specified range.

The defined range will appear as the currently selected palette.

- Temperatures outside of the defined range will appear as the default White Hot or Black Hot palette
- If White Hot or Black Hot are currently selected, the temperatures in the Isotherm range will default to Rainbow

### Spot Measuring

Enable to display the specific temperature value of an object on-screen as you drag your finger on-screen.

- Tap or drag your finger across the screen to view temperatures

### Region of Interest

Enable to display an on-screen box that detects the minimum, maximum, and average temperatures within the outlined area

- **H** represents the highest temperature detected
- **L** represents the lowest temperature detected
- **A** indicates the average temperature detected
- Select the edges of the box to resize, or use the arrows to drag the box to a different location

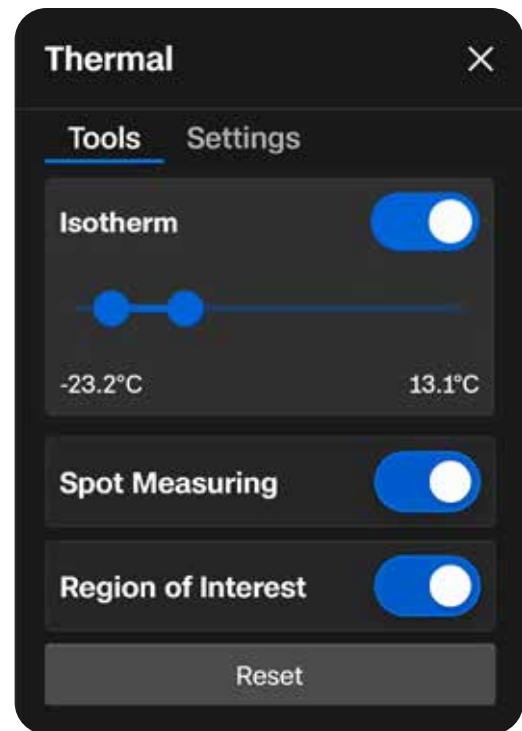

# Thermal Camera

## Spot Measuring



## Region of Interest

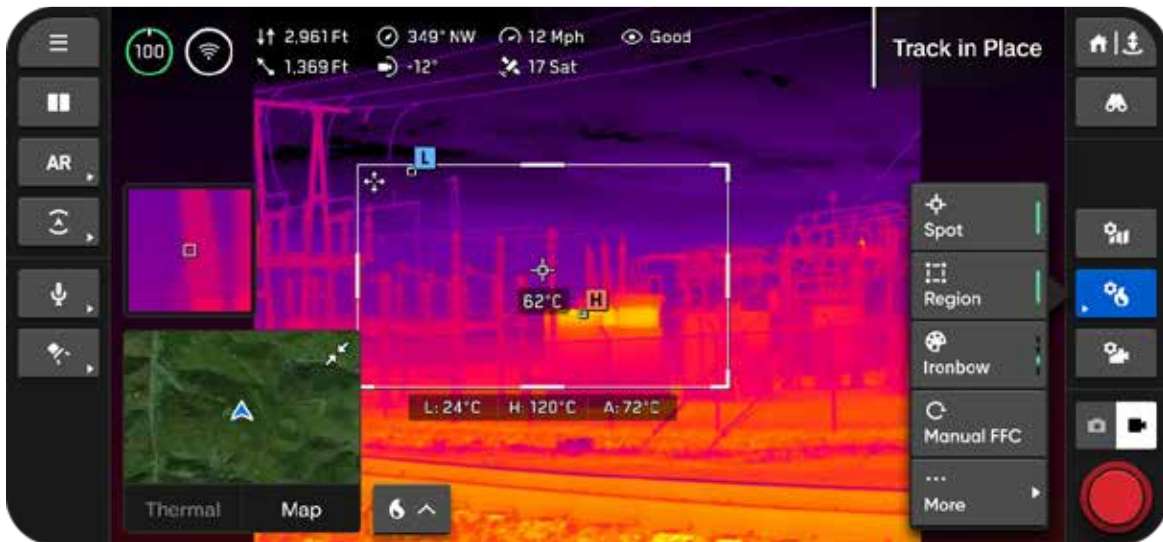

# Thermal Settings

### Color Palette

Visual representations of temperature variations captured by a thermal camera

**Ironbow** - Quickly identify varying temperatures and spot thermal anomalies. Displays a specific range of colors, from blues to reds, which indicate different temperature levels.

- Warmer objects are presented in lighter colors and colder objects in darker colors

**Rainbow** - Uses the colors of a traditional rainbow to distinguish between subtle variations in temperature levels.

- Covers a broader range of colors without emphasizing specific temperature ranges

**White Hot** - Provides a clear visualization of temperature variations without a variety of colors.

- Brighter, whiter colors indicate warmer temperatures
- Darker colors represent cooler temperatures

**Black Hot** - Displays the inverse of a White Hot palette.

- Brighter, white colors indicate cooler temperatures
- Darker, black colors represent warmer temperatures

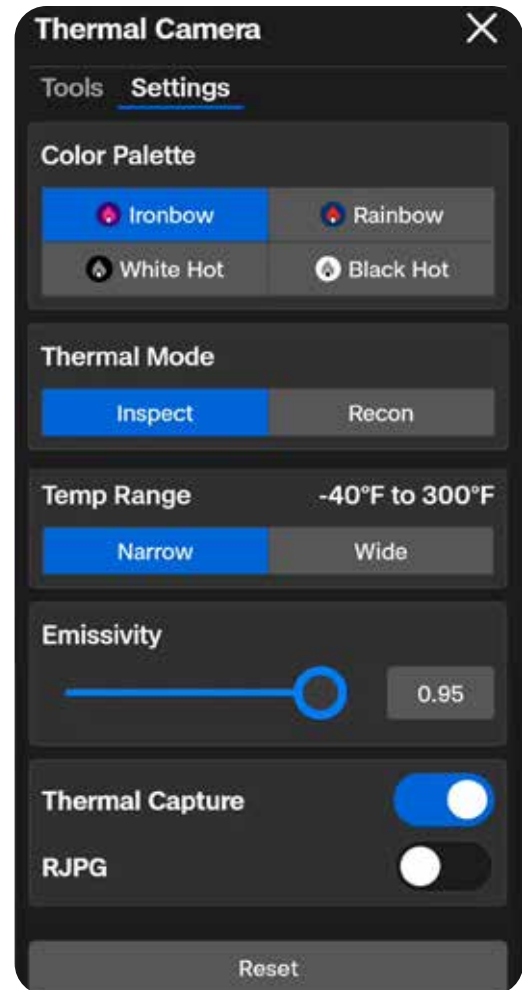

# Thermal Camera

---

## Thermal Mode

Adjust the signal amplification from the camera sensor to enhance temperature differences in an image.

**Recon** - Tuned to increase the contrast between the overall scene and targets. Best for search and rescue or situational awareness use cases. Recon helps differentiate the scene from things like people, vehicles, or animals.

**Inspect** - Tuned to decrease the overall contrast so that temperature anomalies are easier to identify in inspection use cases. This makes it easier to not only see the anomaly, but help track the source from the heat signature.

**Custom** - Allows you to fine-tune your Gain, High Tail, and Low Tail settings. Select Inspect or Recon as your Base Mode, then adjust your Gain, High Tail, and Low Tail settings from there. These settings will persist across flights and will be applied each time you select Custom as your Thermal Mode.

- Gain - Artificially increases contrast of areas with similar temperatures
- High Tail - Adjust saturation of the hotter items in the scene
- Low Tail - Adjust saturation of colder items in the scene

## Temp Range

Select the range of temperatures Skydio X10D will detect.

**Narrow** - Detects temperatures ranging from -40°F to 302°F (-40°C to 150°C)

**Wide** - Detects temperatures ranging from -40°F to 662°F (-40°C to 350°C)

## Thermal Capture

Enable to capture thermal images as JPG files.

**RJPG** - When enabled, your drone will capture a Radiometric JPG in addition to a standard JPG. A Radiometric JPG includes the radiometric data within the photo file.

# Thermal Parameters

### Emissivity

The measure of how efficiently an object emits thermal radiation. Adjust to match the camera readings to the true temperature of the object.

- Higher values means the camera is more sensitive to temperature variations
- Lower values means the camera is less sensitive to temperature variations

Surfaces that are better emitters (higher emissivity) provide more reliable temperature readings. For example, black electrical tape, rusted or oxidized surfaces, bodies of water, or human skin all absorb and emit energy. Set your emissivity high for these types of surfaces.

Reflective surfaces are not good emitters (low emissivity) and therefore not as reliable to measure. Stainless steel, shiny surfaces, or reflective windows tend to have a low emissivity. Set your emissivity low for these types of surfaces, but we recommend gathering your reading from a higher emissivity surface whenever possible.

### Humidity

Set your humidity to accurately reflect the environment you are flying in. This should be the humidity between the sensor and the target.

Humidity is an important parameter to set because your thermal sensor will detect atmospheric conditions like humidity (and distance) which can affect the accuracy of your reading.

### Distance

Set your distance to accurately reflect the range from your thermal sensor to the target.

The further away the target, the more atmosphere your thermal camera will pick up along the way to the target which can affect the accuracy of your reading.

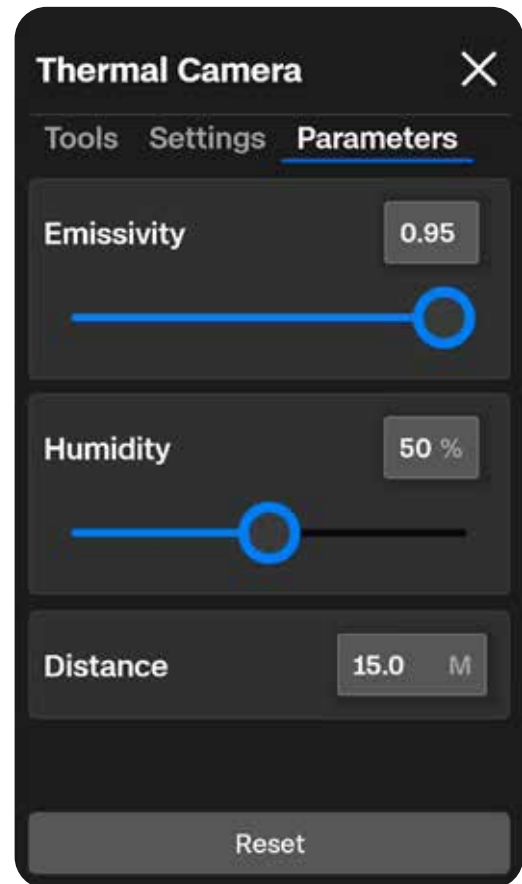



# Flight

Review safe flight practices and important information you need to know while in flight.

## **This section covers**

---

Preflight Inspection

---

Flight Screen

---

Changing Flight Modes

---

Launching

---

Battery Indicator

---

Flight Skills

---

Flying at Night and Flying in Precipitation

---

Returning and Landing

---

# Preflight Inspection



**WARNING:** Carefully inspect your drone and environment before launching to ensure a safe flight.

- **Inspect the chassis** to ensure it is free of damage.
- **Inspect drone arms** and verify they are fully extended and free of damage.
- **Inspect the battery** and confirm it is securely seated prior to launching. Skydio X10D uses magnets to seat the battery which may attract metallic debris. Ensure the connector pins are free of debris or damage.
- **Clean the camera lenses and time of flight sensor** with a clean microfiber cloth. Cameras should be dust and smudge-free before flight.
- **Fan out the propellers and inspect** to verify they are firmly attached and properly seated in the motors and spin freely. Propellers should be free of cracks or damage. Do NOT fly with damaged propellers.
- **Inspect the sensor package** before powering on and ensure it moves freely and is not damaged, and **remove the Sensor Package Lock** before flying.
- **Ensure all USB-C and microSD card seals are secured** over the ports.
- **Check your surroundings** before launching to ensure a safe environment for flight.
- **Point the controller cover/antennas toward the drone** for maximum wireless performance.
- **Verify batteries are fully charged** before flying.
- **Check for drone and controller updates** before flying.

## Maximum Wireless Performance

For maximum wireless performance when flying over a direct link, always maintain a direct line of sight between the controller and Skydio X10D. Point the controller cover toward the drone, especially when flying at close range high altitude.

Signal strength and maximum control range may be affected when flying in areas with electromagnetic interference.

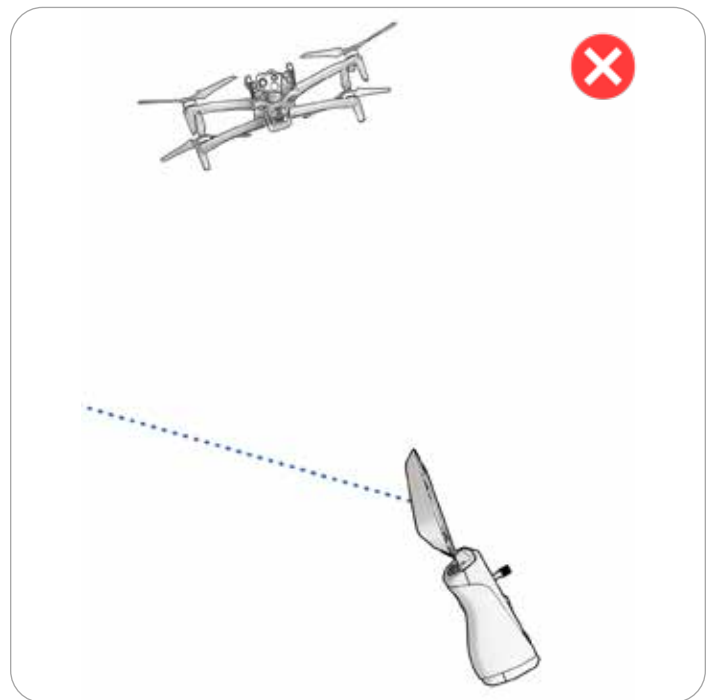
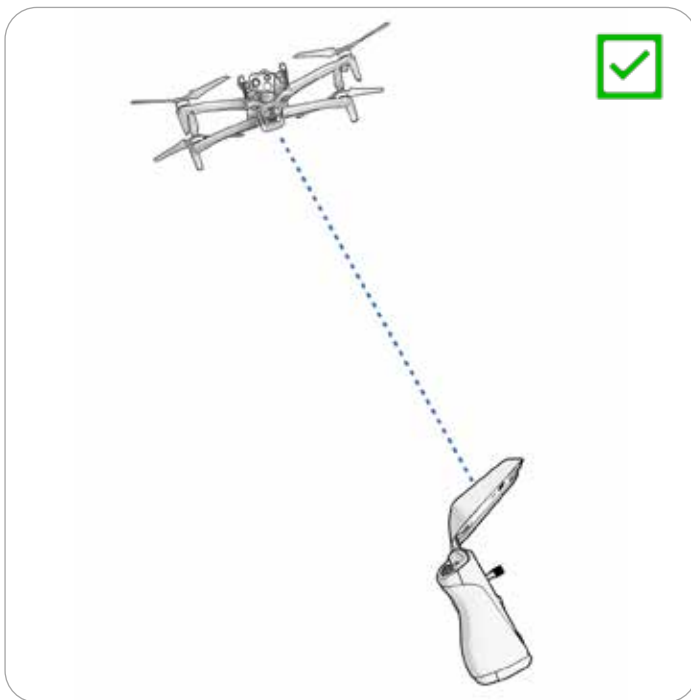

# Pairing Devices

Step 1 - Power on Skydio X10D vehicle and the X10D controller

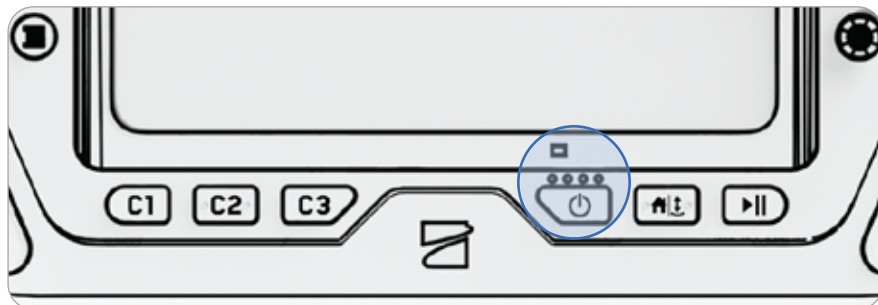
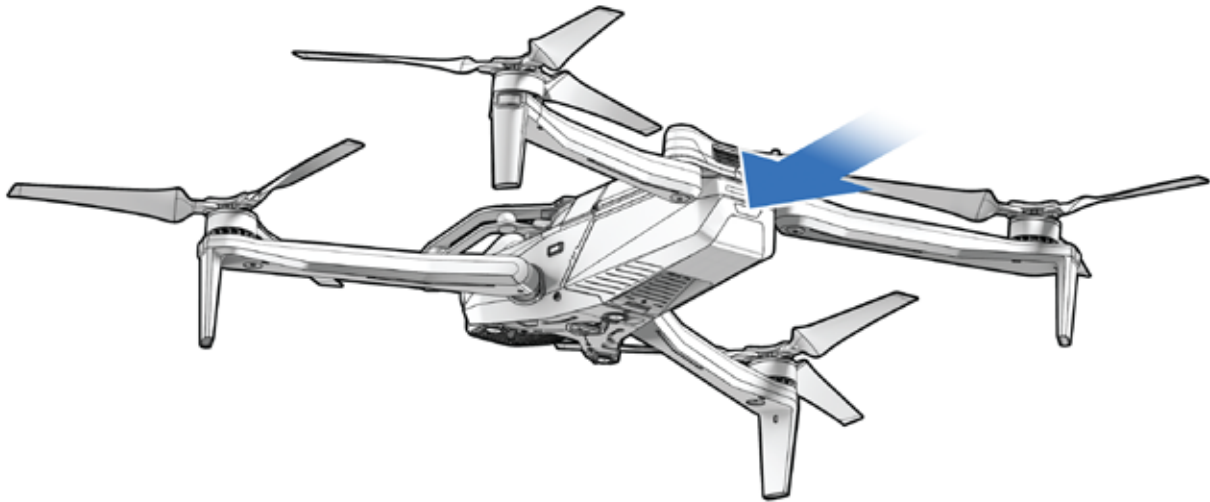

## Step 2 - Wait for devices to connect

A drone and controller that were previously paired will automatically connect.



# Launching

### Step 1 - Find a clear, safe area to launch

Find a clear, safe area to launch and place your drone on a stable surface. X10D is capable of launching with 6.7 ft (~2 m) of clearance however 10 ft (3 m) of clearance in all directions will allow for a safer launch. Operating in tighter spaces may increase the risk of collision, injury or damage during launch.

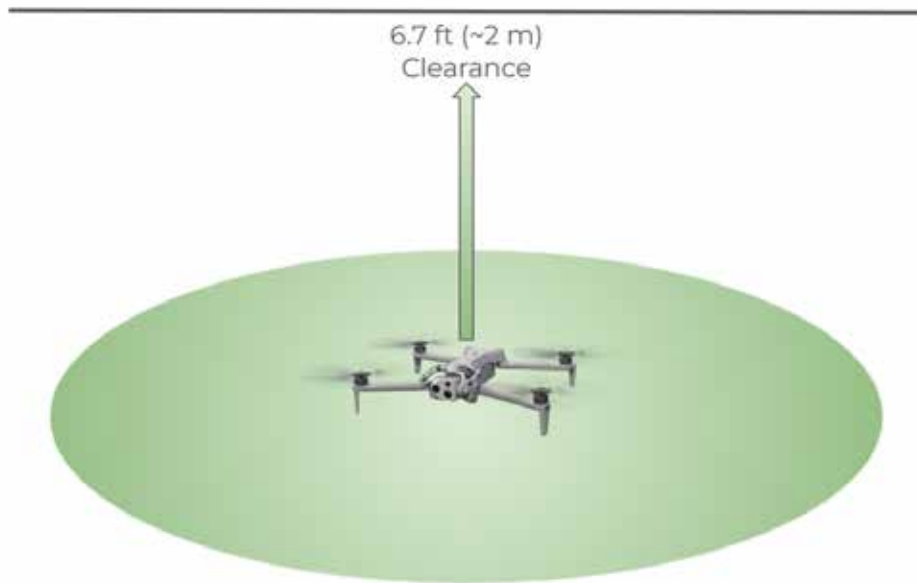

**NOTE:** Before your first flight, make sure to set your Return and Lost Connection Behaviors (Global Settings > Return). Scan the QR Code for more information about Return and Lost Connection Behaviors.



Low Launch limits the launch height to 3 ft (1 m) ensuring the pilot has quicker flight control and allowing tactical users to maintain a lower profile.

- Toggle On/Off
- The setting persists across flights and power cycles
- Requires 6.7 ft (2 m) of vertical clearance
- If Obstacle Avoidance is disabled, Low Launch will not be available
- If Attitude Mode is enabled, Low Launch will not be available

# Flight

---

## Step 2 - Launch

Your drone will rotate 360° during launch to calibrate its Inertial Measurement Unit (IMU) and navigation system, climb to 10 ft (3 m), and hover.

### Option 1 - Drag the on-screen slider

The drone will initiate launching when you lift your finger away from the screen.

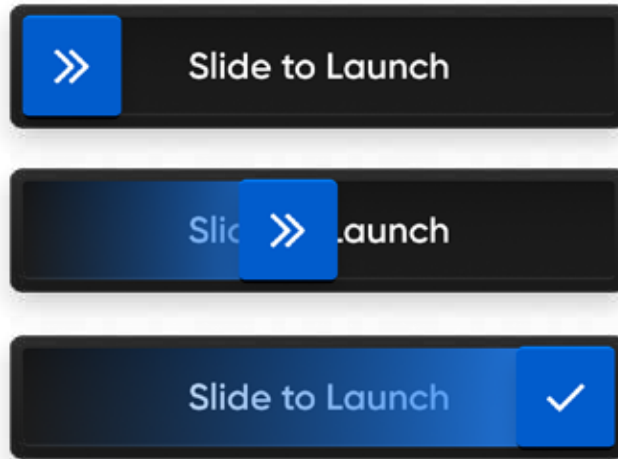

### Option 2 - Press and hold the Launch/Land button on the controller

The drone will initiate launching when you see the on-screen check mark.

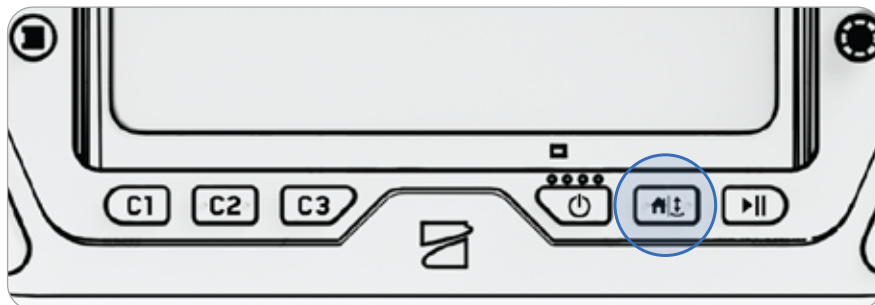

# Flight

## Step 3 - Acquire GPS Lock

The GPS indicator in the telemetry bar will spin until the drone has acquired GPS Lock and established heading.

When the **Weak GPS Alt Limit** toggle is enabled, your drone will not be able to ascend above 164 ft (50 m) when GPS is weak.

Fly laterally to acquire a GPS lock and ascend.



# Hand Launching

Launching and landing Skydio X10D from your hand is a quick and convenient way to start or end your flight, particularly if you are not in a clear, level area. For your safety, always use caution when hand launching. This maneuver is dangerous and should not be attempted in unstable environments, such as during high winds or while standing on a moving vehicle or boat.



**WARNING:** Obstacle avoidance is disabled when the drone is below 10 ft (3 m) during landing. Exercise extreme care to avoid injury or damage. Do not touch spinning propellers.

### Step 1 - Ensure you have clearance above and in front of you

### Step 2 - Hold the drone away from you (sensor package facing away from your body)

- Lightly grip the battery
- Keep the drone level, still, and at arm's length from your body
- Your fingers should be below the Skydio X10D chassis and away from the propellers at all times
- Ensure your hand is steady

### Step 3 - Launch

Press and hold the Launch Button on the X10D Controller. Slowly relax your grip as Skydio X10D launches.

- Do not push or throw the drone up in the air
- Keep your hand still - the drone will slide off your palm and take flight on its own



**TIP:** Quick Launch allows you to use the battery power button to hand launch your Skydio X10D so that you do not have to balance the controller in one hand and your drone in the other. Press the battery button four times to initiate the launch. Press the battery power one additional time to abort the launch.

# Flight Screen

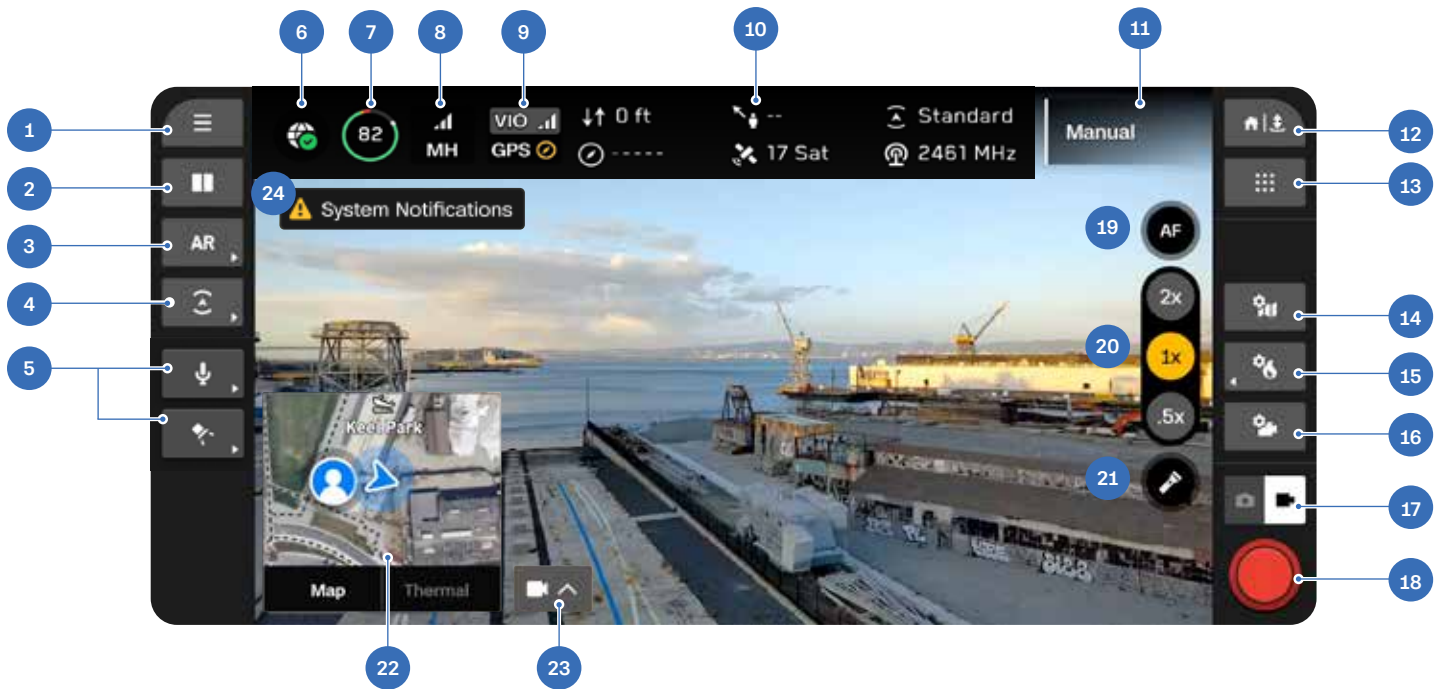

- |  |   |
|--|---|
| <b>1.</b> Global Settings                  | <b>13.</b> Flight Skills                    |
| <b>2.</b> Display Layout                   | <b>14.</b> Map Settings                     |
| <b>3.</b> AR Quick Actions                 | <b>15.</b> Thermal Settings                 |
| <b>4.</b> Obstacle Avoidance Quick Actions | <b>16.</b> Camera Settings                  |
| <b>5.</b> Attachments Quick Actions*       | <b>17.</b> Camera Mode                      |
| <b>6.</b> WiFi Enabled Indicator           | <b>18.</b> Shutter                          |
| <b>7.</b> Drone Battery Level              | <b>19.</b> Focus Control                    |
| <b>8.</b> Radio Signal Strength            | <b>20.</b> Zoom                             |
| <b>9.</b> Navigation Mode/Health Indicator | <b>21.</b> Flashlight On/Off (VT300-L Only) |
| <b>10.</b> Telemetry (customizable)        | <b>22.</b> Picture-in-Picture (PiP)         |
| <b>11.</b> Active Flight Skill             | <b>23.</b> View Selector                    |
| <b>12.</b> Return/Land                     | <b>24.</b> Notifications                    |

\*Appears when you are currently using an attachment.

## Battery Indicator

The vehicle battery level percentage **dynamically changes** during your flight based on altitude and distance from the return location and attachments in use. Monitor the Battery Indicator while flying to understand how much battery is:

- Available for flight
- Available for return
- Required to land

The battery on Skydio X10D has the ability to warm itself in cold environments. For more information, read the Maintenance section.

**Green** indicates the battery capacity for nominal flight before the time limit required to safely return and land.

- Decreases as battery capacity diminishes
- Adapts based on your altitude and distance from the return location



**Yellow** indicates how much battery is required to safely return.

- Adapts based on your altitude and distance from the return location



**Red** indicates how much battery is required to land.

- Adapts based on your altitude and distance from the return location



**Lightning bolt** indicates the battery is connected and charging.

**Three dashes** indicate the battery is disconnected.

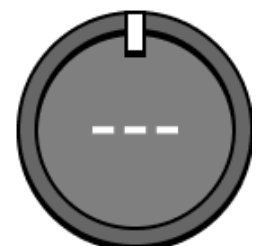

# Navigation Indicator

Indicates the health of the drone navigation systems, and which navigation mode is actively in use (highlighted).

- **VIO** - Visual Inertial Odometry. This is the visual navigation system of the drone.
- **GPS** - Global Positioning System
- Attitude Mode

## VIO and GPS states: Healthy, Degraded, Failed, or Disabled:

- Gray background highlights the primary navigation mode
- White status bars indicates VIO/GPS stability
  - One white bar indicates a degraded state that may be close to failure
  - Zero white bars indicates that the navigation source has failed
- GPS Off will display if GPS has been toggled off
- The yellow compass indicates GPS is awaiting heading
- If the GPS heading has not set, you will receive a notification prompting you to move the drone laterally to establish heading.
- Yellow highlight indicates that your active navigation source is weak and your backup source is unavailable.
- If the highlighted source fails, the drone will enter Attitude Mode

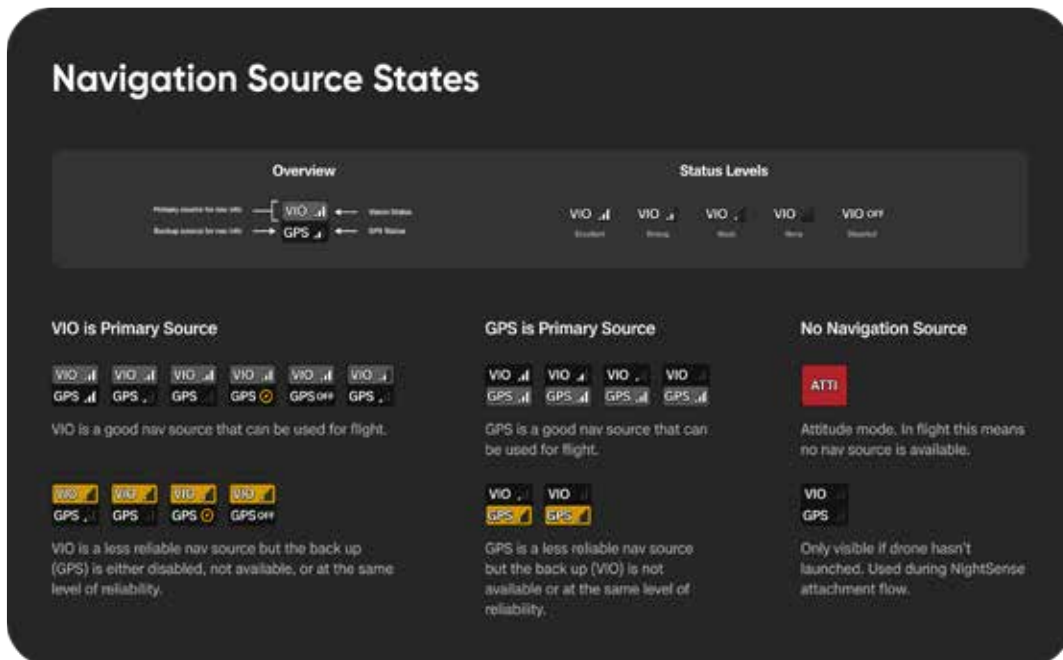

# Flight Skills

Skydio offers a range of manual and autonomous controls called **Flight Skills**. Select your desired skill and Skydio X10D will intelligently fly itself to assist with the task at hand.

By default, you will start in the Manual Flight Skill, which provides a traditional flying experience.

## Skydio Flight Skills

**Manual:** Traditional flying experience. Obstacle avoidance settings will persist when flying manually, allowing Skydio X10D to route itself around obstacles, modifying any commands that could potentially cause a collision. Fly using Control Mode 1, Mode 2 (default), or Mode 3.

**Orbit Point:** Rotate around a user-selected point-of-interest in either a clockwise or counter-clockwise direction, keeping the point in the center of the frame. Set a GPS position on a map.

**Scout:** Follow and track a GPS position at long range, with the ability to adjust and reposition your drone. Skydio Scout supports GPS tracking of the Skydio X10D Controller

**Track in Place:** Initiate tracking a person or vehicle and Skydio X10D will hover in a fixed position, as if affixed to a virtual tripod. The drone will automatically yaw and adjust the sensor package pitch to maintain tracking. Tracking in both Color and Thermal is available.

**Waypoints:** Create and executive multi-waypoint GPS missions, preflight or postflight.



**INFO:** [Visit our website](#) for more information on additional Flight Skills available for purchase.

# Changing Flight Skills

## Step 1 - Select the Flight Skills icon

- Manual
- Orbit Point
- Scout
- Track in Place
- Waypoints

## Step 2 - Select your Flight Skill

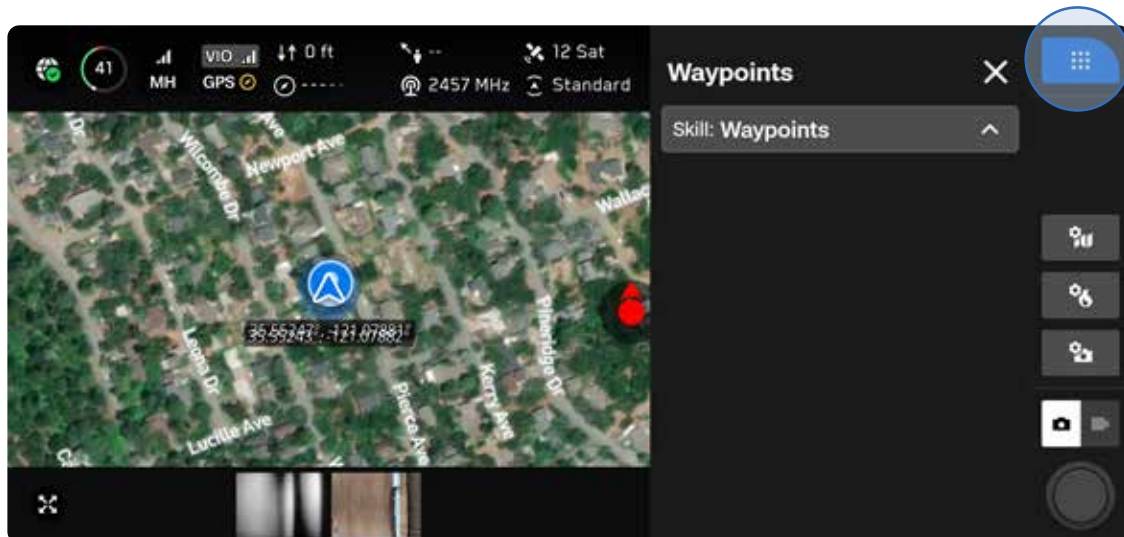

# Flight

## Step 3 - Adjust settings (optional)

Each skill may have its own adjustable settings which only affect the selected skill. If the selected skill has adjustable settings, they will appear below the skill name within the Flight Skills menu.

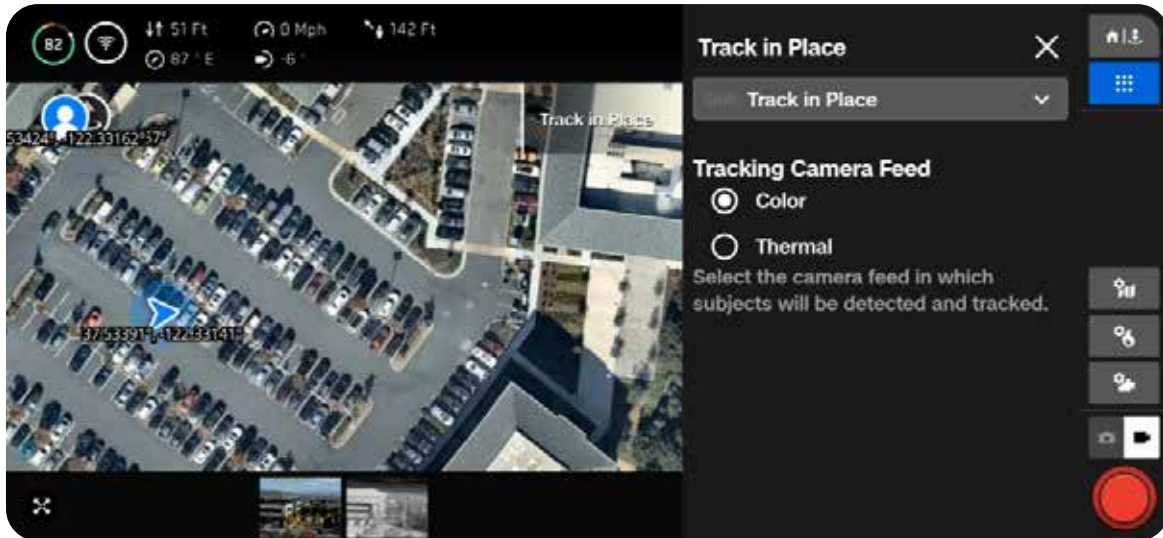

# Flying at Night

## Flying at Night without NightSense

When flying at night or in low light conditions without NightSense, Skydio X10D will primarily use GPS to navigate and obstacle avoidance will be disabled.

### Step 1 - Enable Low Light mode

You will see an on-screen notification to enable Low Light mode if there is insufficient light. You may also select the Global Settings icon, select Sensing, then select Low Light.

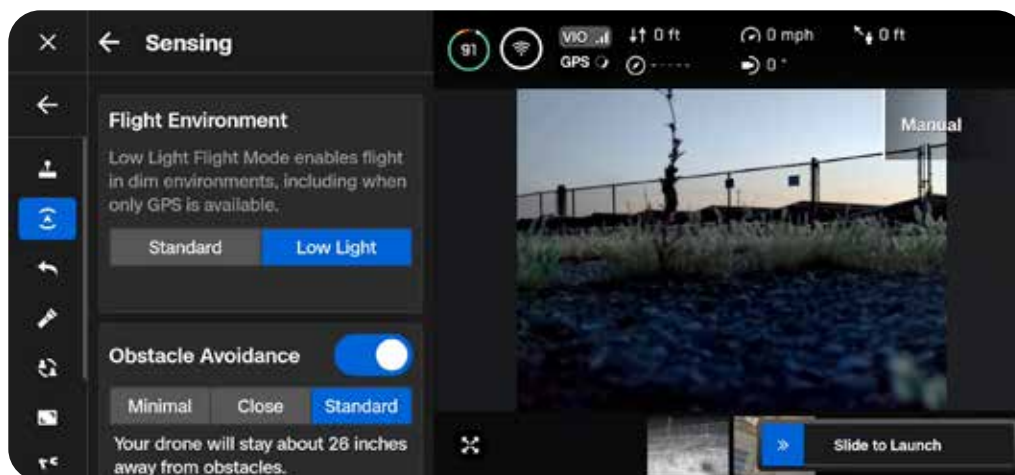
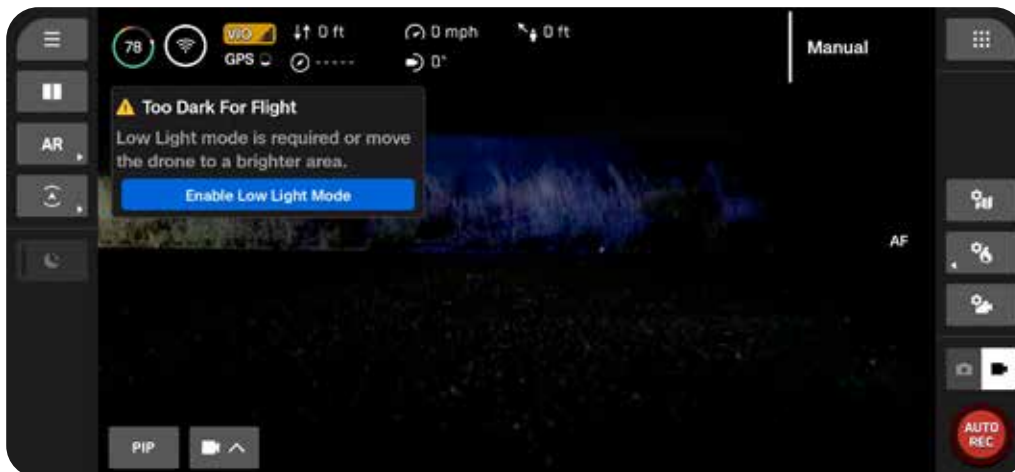

## Step 2 - Configure your lighting settings

Improve visibility by enabling infrared or visible strobe lights. Select Lighting then toggle on RGB (default navigation lights), Infrared, or Strobe lights. Infrared and Strobe lights cannot be on at the same time.

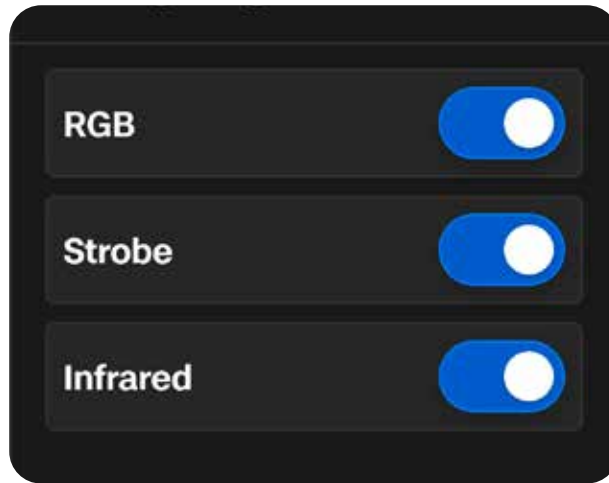

# Flight

## Step 3 - Calibrate your drone

Exit the Global Settings menu, then select Fly Now. Hold your drone from the bottom with the camera facing away from your body and wave from side to side to calibrate. You will see an on-screen message when calibration is complete.

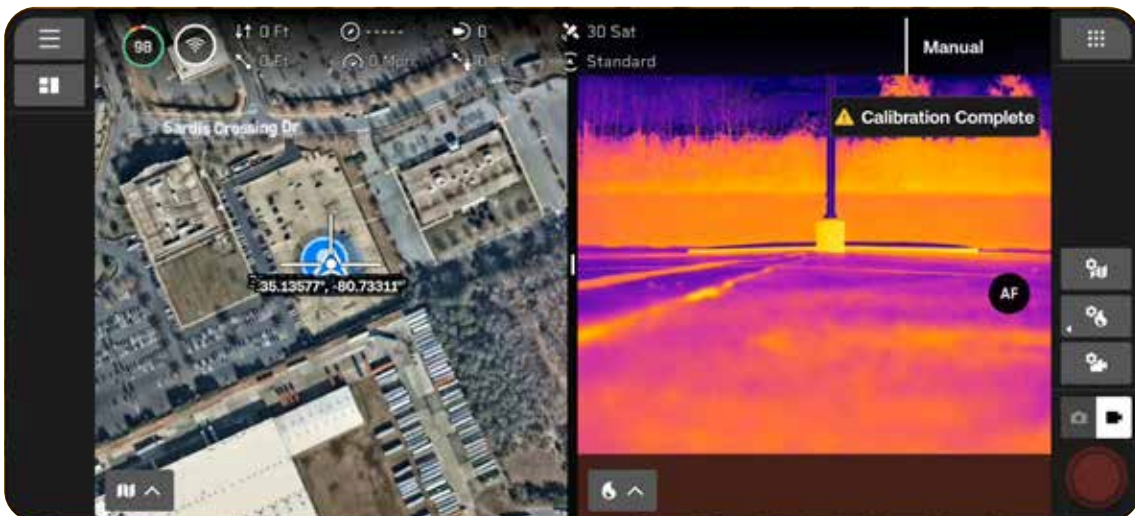
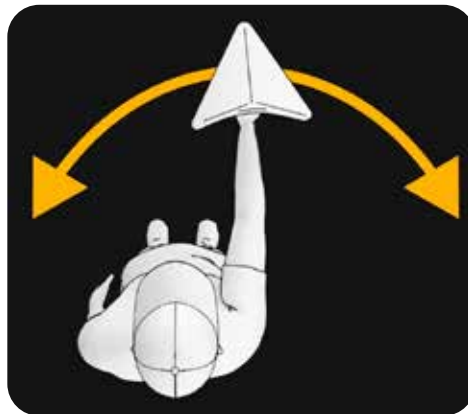
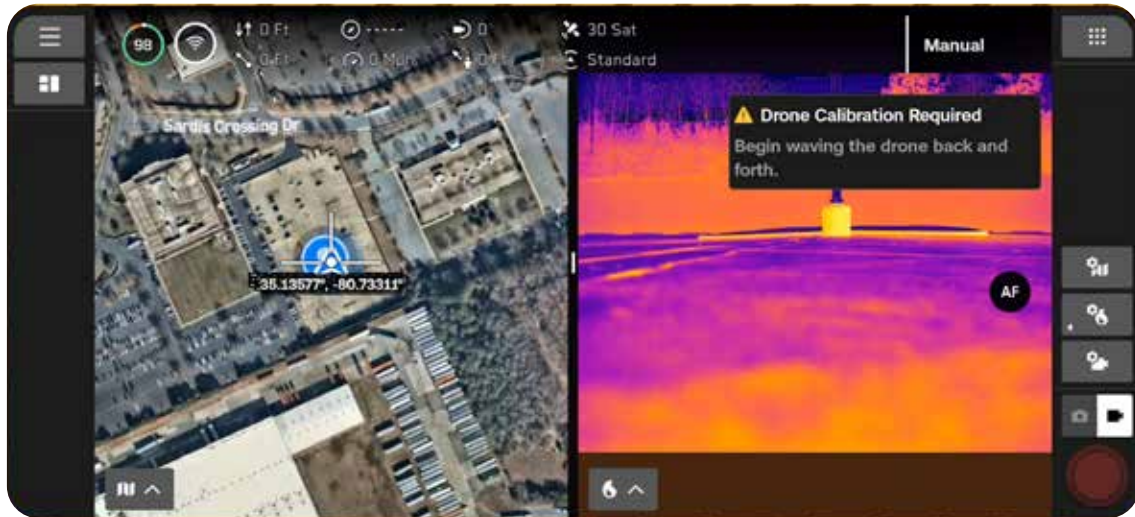

## Flight

---

### Step 4 - Launch Skydio X10D

Your drone will rotate 360° during launch to calibrate its Inertial Measurement Unit (IMU) climb to 16.5 ft (5 m), and hover. Obstacle avoidance will be disabled.

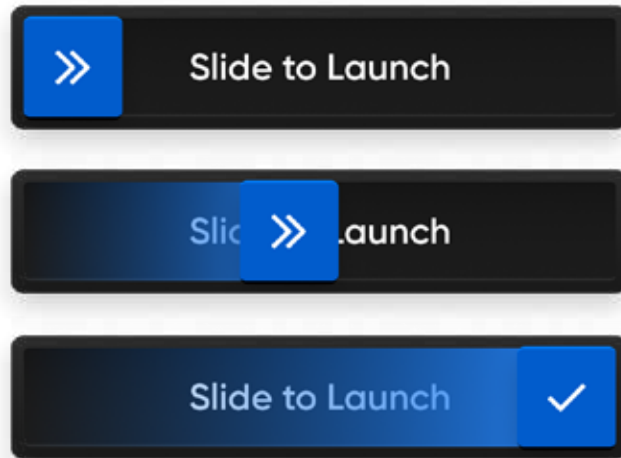

**WARNING:** Obstacle avoidance is disabled in Low Light mode without NightSense. Fly with extreme caution!

## Flying at Night with NightSense

The Skydio NightSense attachments and add-on software allow you to leverage Skydio X10D visual navigation and obstacle avoidance capabilities even when flying at night.

The set of two NightSense attachments cast a light above and below your drone. This light illuminates the area, unlocking Skydio visual navigation and obstacle avoidance when flying at night and in low-light conditions.



### **WARNINGS:**

- *After prolonged use of the NightSense attachments, they may be hot to the touch and could burn your hand. After landing, wait for your attachments to cool down before handling.*
- *Do not stare directly into your NightSense modules at close range. NightSense attachments, both Visible and Infrared, may cause eye damage if held closer than an arm's reach for 30 seconds or more.*
- *Due to potential burn risk and eye damage, Skydio does not recommend Hand Landing your drone while using NightSense.*

### **Step 1 - Install your attachments**

Visit [Getting Started with NightSense for Skydio X10D](#) for step-by-step installation instructions.

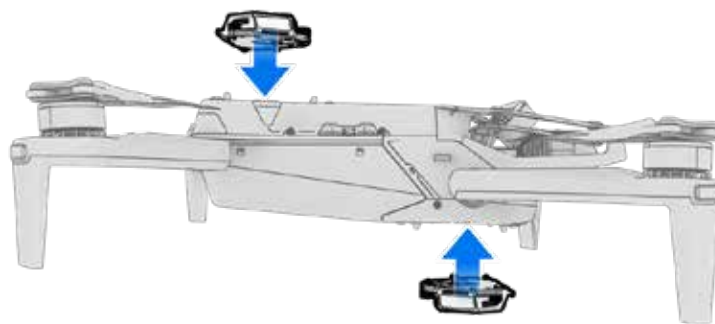

# Flight

## Step 2 - Enable Low Light mode

You will see an on-screen notification to enable Low Light mode if there is insufficient light. You may also select the Global Settings icon, select Sensing, then select Low Light.

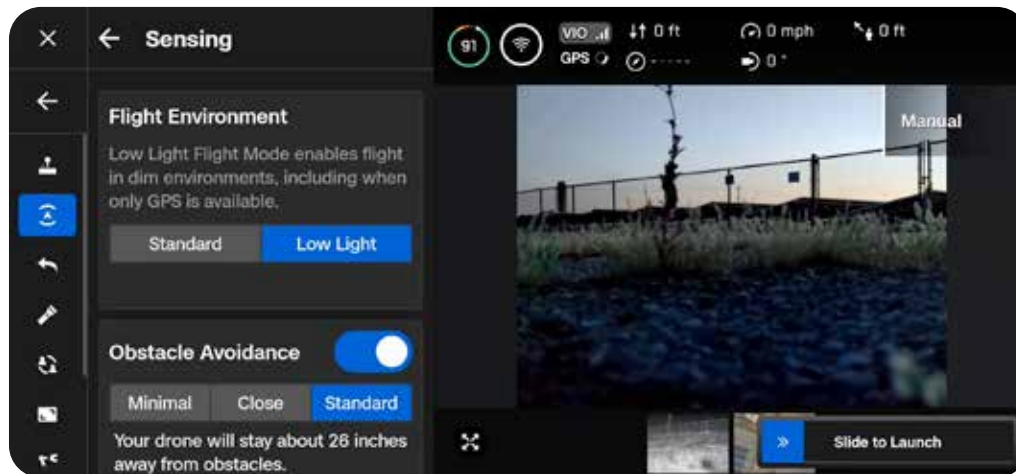
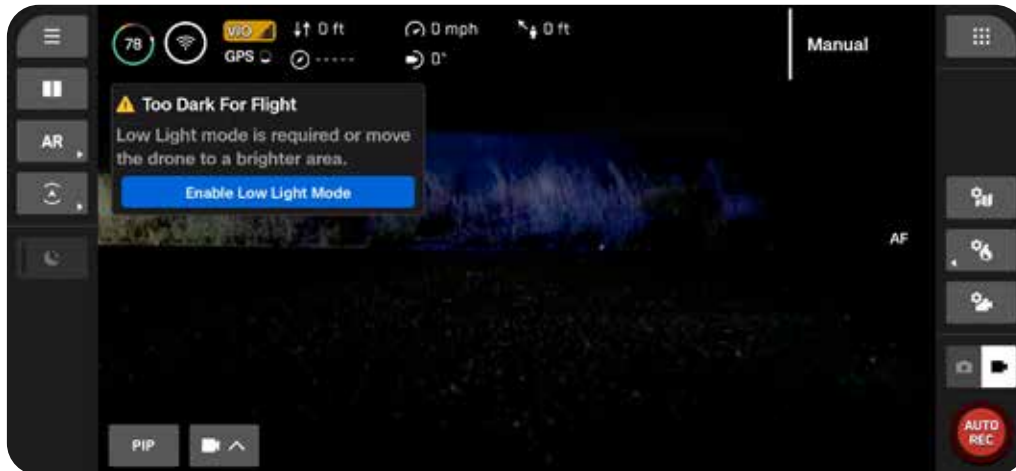

# Flight

## Step 2 - Configure your lighting settings

Improve visibility by enabling infrared or visible strobe lights. Select Lighting then toggle on RGB (default navigation lights), Infrared, or Strobe lights. Infrared and Strobe lights cannot be on at the same time.

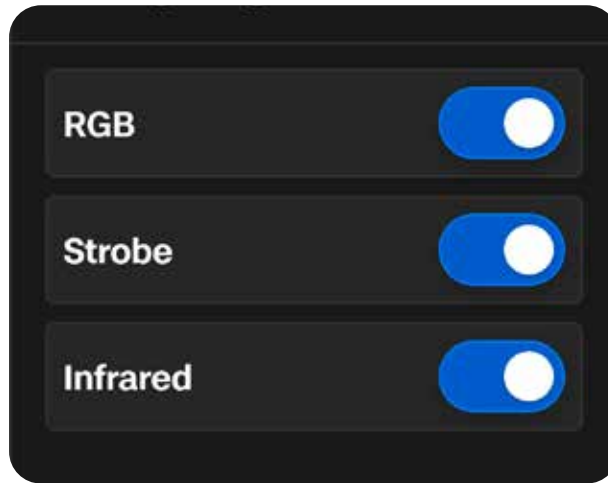

## Step 3 - Enable NightSense

By default, NightSense will automatically turn on when entering Low Light mode. Use the left sidebar quick action to subsequently turn NightSense on or off. The visible or infrared lights from the NightSense attachments will illuminate the area around the drone.



# Flight

---

## Step 4 - Launch Skydio X10D

Your drone will rotate 360° during launch to calibrate its Inertial Measurement Unit (IMU) climb to 10 ft (3 m), and hover.

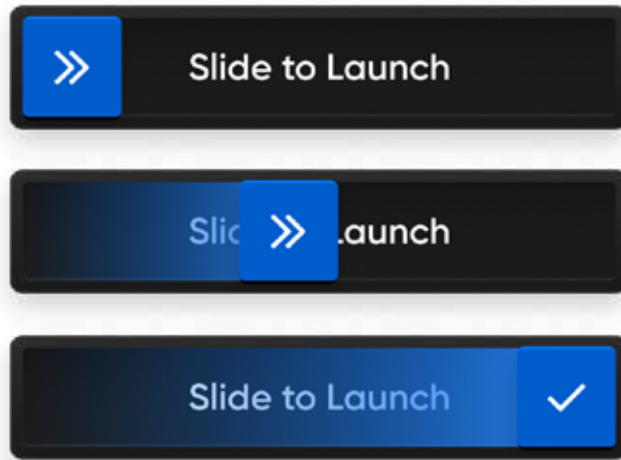

**NOTE:** Skydio X10D is limited to a max speed of 18 mph (8 m/s) with NightSense on.



**INFO:** For more information about flying with NightSense, including configuring settings visit: [Getting Started with NightSense for Skydio X10D](#).

## Inflight Safety Considerations

### Obstacle Avoidance

- **NightSense ON:** Obstacle avoidance is active when NightSense is on. Enable the AR Depth View to visually display where Skydio X10D detects obstacles in the environment, especially when using Infrared NightSense attachments, to assist with situational awareness.
- **NightSense OFF:** When in Low Light mode, obstacle avoidance is disabled. Take extra caution when piloting the drone to avoid obstacles and stay clear of people.

### GPS Signal

- **NightSense ON:** When NightSense is on, visual navigation (VIO) is the primary navigation method, however if flying at high altitudes the drone will rely on GPS. Monitor your VIO and GPS health status inflight; if both VIO and GPS degrade the drone will enter Attitude Mode.
- **NightSense OFF:** Maintaining a strong GPS signal is paramount when operating X10D at night. If Skydio X10D loses GPS while in Low Light mode, and there is not enough ambient light for VIO, it will enter Attitude Mode.

### Visibility

Improve visibility by enabling infrared or visible strobe lights. Skydio X10D strobe lights meet the FAA requirement of being visible at a distance of 3 statute miles.

### Return Behavior

Review the return behavior height setting in the Global Settings menu.

**NightSense OFF:** Skydio X10D does not avoid obstacles when in Low Light mode and NightSense off, so you may want to set the drone's return height such that it will be above any potential obstacles.

### Landing

When landing, use the controller joystick to descend down to 15 feet (4.6 meters), when you are ready to land, press and hold the LAND button on the screen or the controller. Do not hand launch or hand land at night.



**WARNING:** Due to potential burn risk and eye damage, Skydio does not recommend Hand Landing your drone while using NightSense.

# Flying in Precipitation

Skydio X10D is IP55 rated and able to fly in light to moderate precipitation when **obstacle avoidance** is disabled. Skydio will primarily use GPS to navigate, so it is critical to have a strong GPS signal when flying in precipitation.



**CAUTION:** *Flight in icy conditions is not supported and may result in the loss of your drone.*

## Quick Reference

### Flying in precipitation during the day

- Select Standard as your Flight Environment
- Disable obstacle avoidance via the quick action or the settings menu
- Only fly with a strong GPS signal

---

### Flying in precipitation at night

- Select Low Light as your Flight Environment
  - Disable obstacle avoidance, disable NightSense (if you have NightSense attachments installed)
  - Only fly with a strong GPS signal
-

## Preflight

**Step 1 - Ensure all rubber seals on the drone are securely closed**

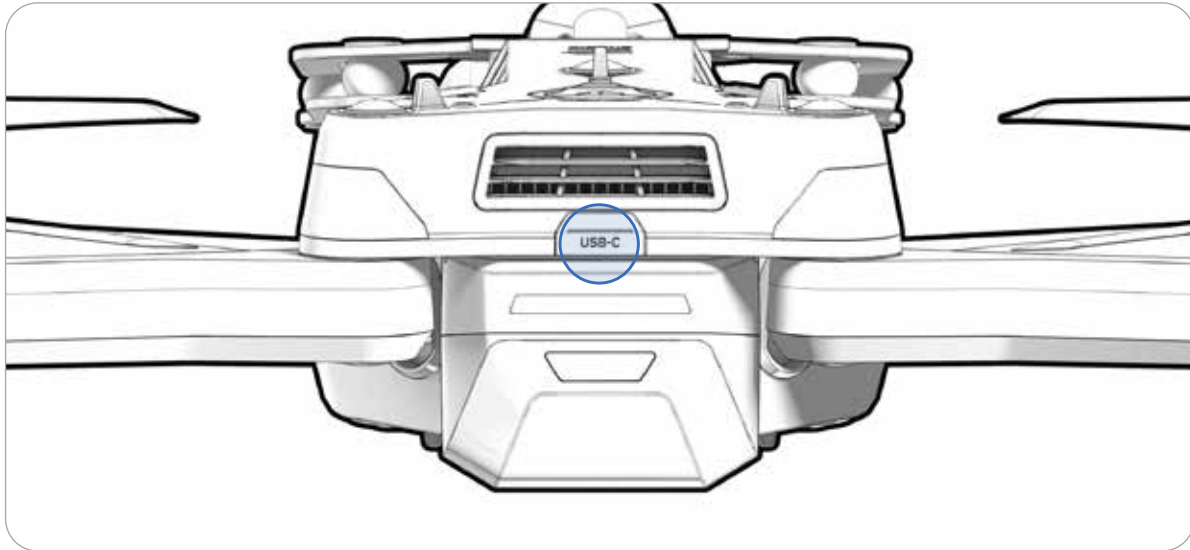

**Step 2 - Select your Flight Environment**

Select the Global Settings icon, select Sensing, then select Standard (flying in precipitation during the day) or Low Light (flying in precipitation at night).

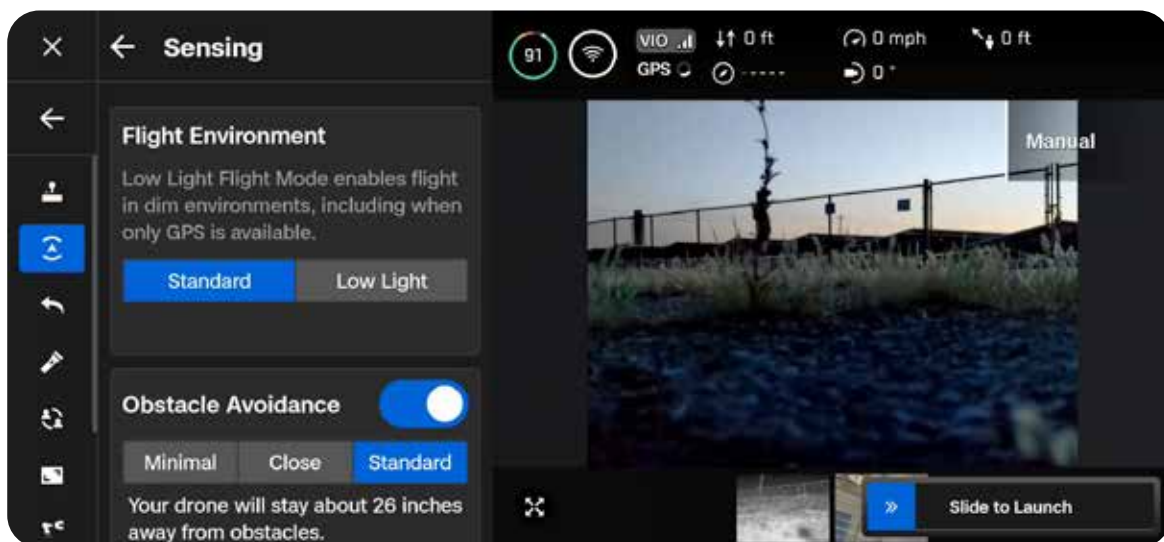

# Flight

## Step 3 - Calibrate your drone (if in Low Light mode)

Exit the Global Settings menu, then select Fly Now. Turn off NightSense (if on). Hold your drone from the bottom with the camera facing away from your body and wave from side to side in a straight line to calibrate. You will see an on-screen message when calibration is complete.

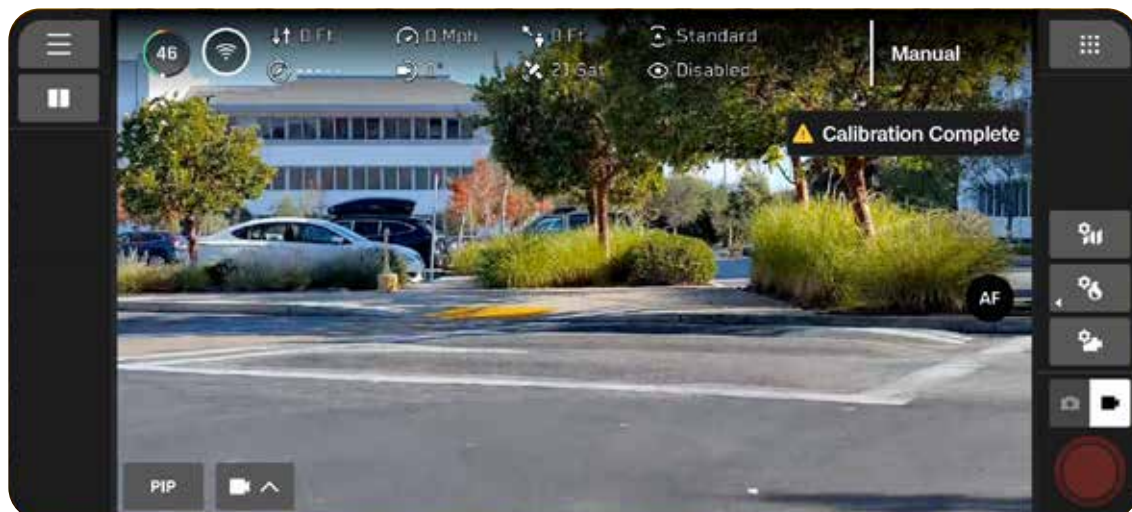
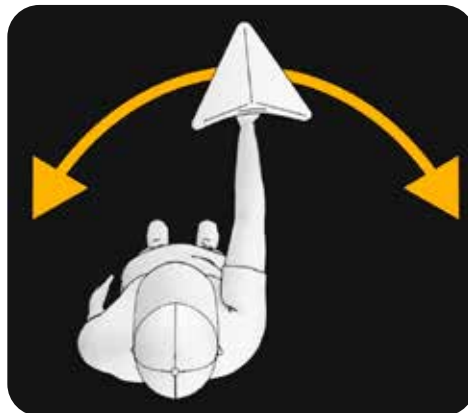
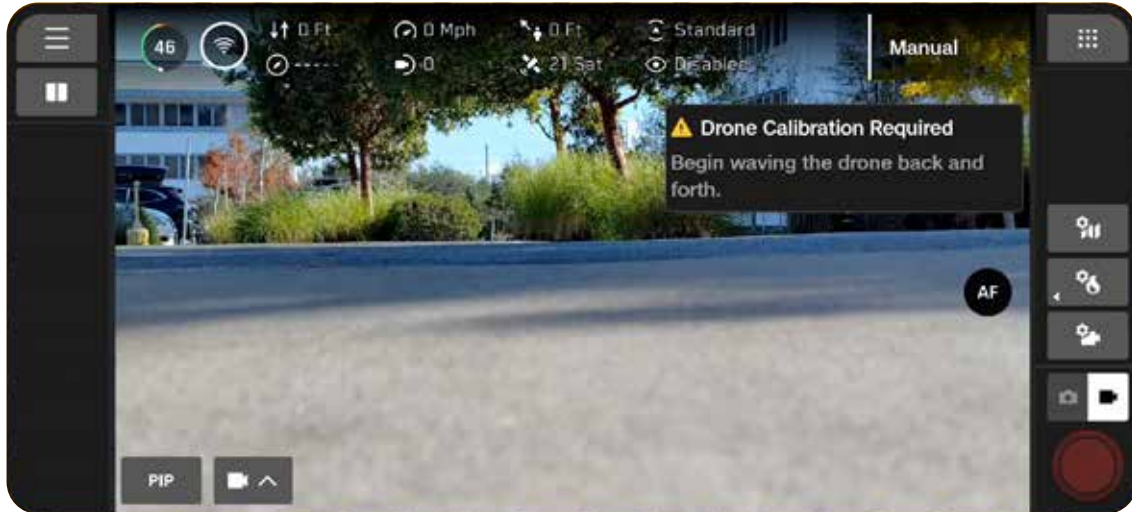

# Flight

## Step 4 - Disable obstacle avoidance

Disable obstacle avoidance from the quick action menu on the Flight Screen. Turn off NightSense if on.



**NOTE:** If it begins to precipitate during a flight, disable obstacle avoidance inflight.

## Step 5 - Launch Skydio X10D

Your drone will rotate 360° during launch to calibrate its Inertial Measurement Unit (IMU) climb to 16.5 ft (5 m), and hover. Obstacle avoidance will be disabled.

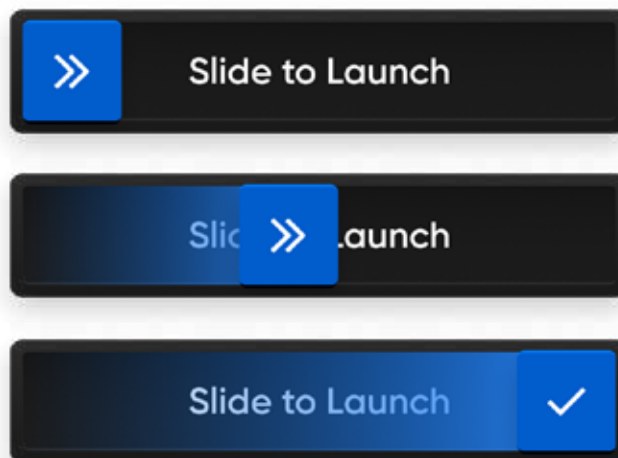

## Step 6 - Lock controller touchscreen (optional)

To prevent touchscreen interference from precipitation, you have the ability to lock all touchscreen inputs. While holding the back button, press the D-pad down to lock or unlock the screen.



**NOTE:** You will not be able to make on-screen selections while touchscreen inputs are locked. Controller buttons are still functional and can be customized to perform specific actions (Controls > Input Mapping).

# Inflight Safety Considerations

### Obstacle Avoidance

When flying in precipitation, obstacle avoidance must be disabled. Take extra caution when piloting the drone to avoid obstacles and stay clear of people.

### GPS Signal

Maintaining a strong GPS signal is paramount when flying in precipitation, since Skydio X10D is navigating primarily using GPS. If Skydio X10D loses GPS, it will enter Attitude Mode.

### Visibility

Improve visibility by enabling infrared or visible strobe lights. Skydio X10D visible strobe lights meet the FAA requirement of being visible at a distance of 3 statute miles.

### Wireless Range

Moisture in the air may significantly reduce wireless range.

### Return Behavior

Review the return behavior height setting in the Global Settings menu. Obstacle avoidance must be disabled when flying in precipitation, so you may want to set the drone's return height such that it will be above any potential obstacles.

### Landing

When landing, use the controller joystick to descend down to 15 feet (4.6 meters), when you are ready to land, press and hold the LAND button on the screen or the controller. Do not hand launch or hand land in precipitation.

## Postflight

After flight operations in precipitation, follow all postflight steps before stowing your drone to ensure it is properly maintained and does not sustain any water damage.



**CAUTION:** Do not stow Skydio X10D while wet.

### Step 1 - Power off Skydio X10D

### Step 2 - Allow water to drain

Install the sensor package lock to hold the sensor package in place. Rotate the drone to allow water to drip out of all egress areas.

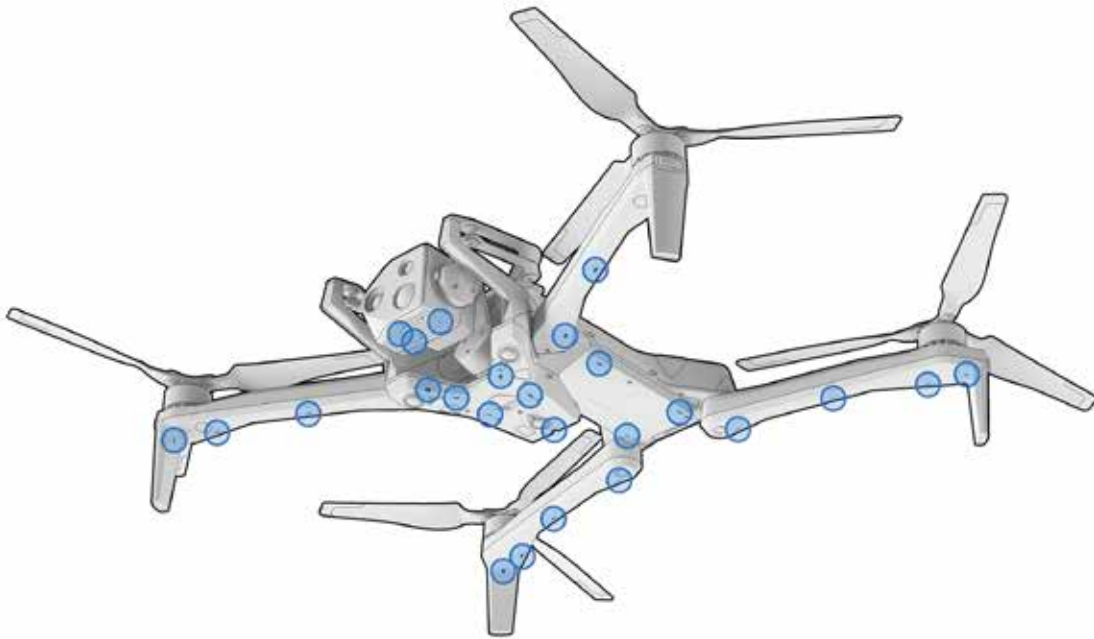

**NOTE:** Skydio is IP55 rated and able to fly in light to moderate precipitation. It is expected for water to enter different areas of the drone and draining postflight is normal. Sensitive components are protected.

## Step 3 - Remove the battery



## Step 4 - Wipe camera lenses clean

Use a microfiber cleaning cloth to wipe the lenses clean and prevent dried water spots from forming.

## Step 5 - Air dry for a minimum of 12 hours

Leave the drone to air dry in a ventilated, temp-controlled environment with the arms deployed in an upright position. Do not open any seals, including the USB-C charge port, until after the drone is dry. Do not remove the sensor package or any attachments while the drone is wet.

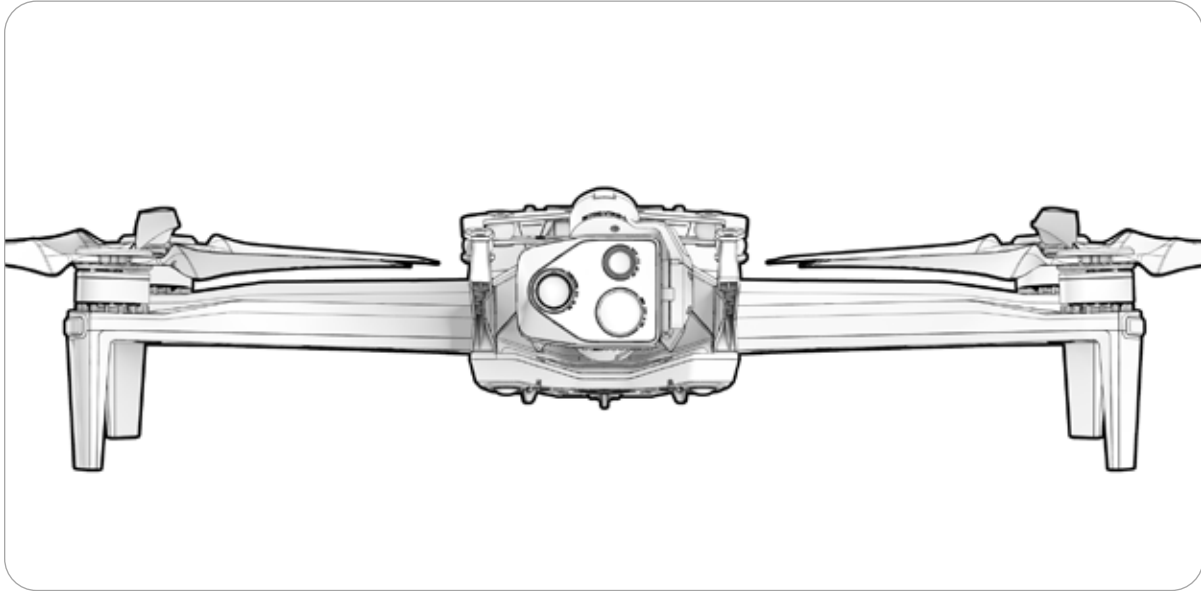

# Returning and Landing



Scan for more information about Return and Lost Connection Behaviors.

**Step 1 - Select the Return/Land button in the top right of your screen or on the controller**

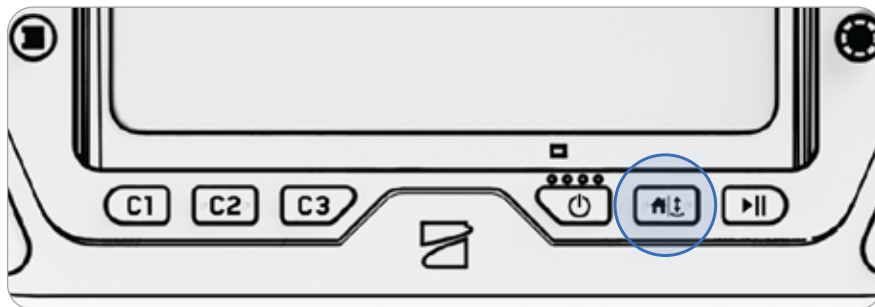

# Flight

## Step 2 - Choose your return location or land in place



### Home

Returns to a Home Point previously set on the map (GPS required)



### Launch

Returns to the Launch Point



### Pilot

Returns to the location of the Skydio X10D Controller

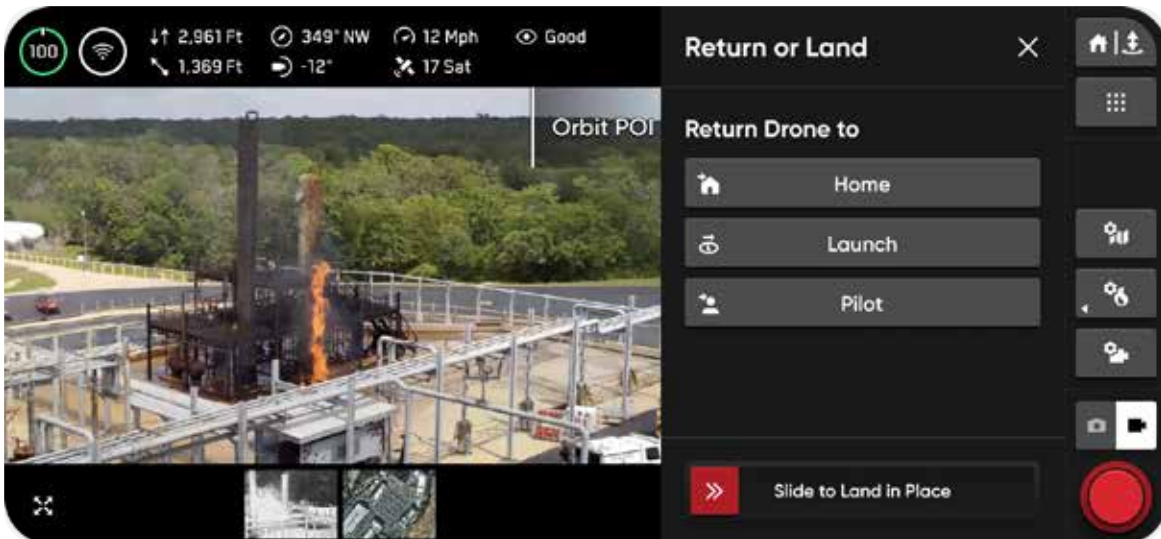

# Flight

---

You have three options when landing in place:

## Option 1 - Select and drag the on-screen slider

Landing begins when you lift your finger away from the screen.



## Option 2 - Press and hold the Return/Land button on the controller

Landing begins when you see the on-screen check mark.

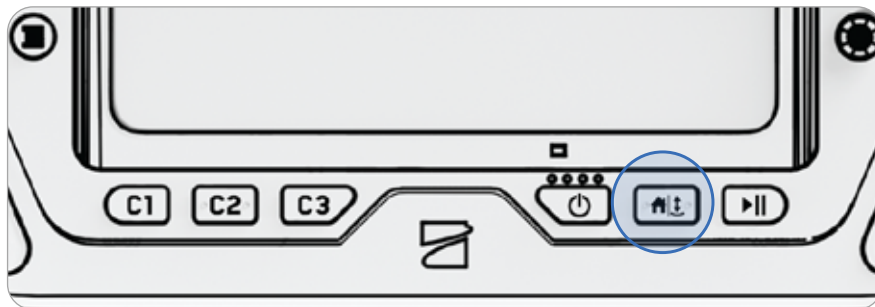

## Option 3 - Press and hold the Return/Land button on-screen

Landing begins when you see the on-screen check mark.



**WARNING:** Obstacle avoidance is disabled when the drone is below 10 ft (3 m) during landing. Exercise extreme care to avoid injury or damage. Do not touch spinning propellers.

# Hand Landing

Landing Skydio X10D in your hand is a quick and convenient way to start or end your flight, particularly if you are not in a clear, level area. For your safety, always use caution when hand launching or landing.



**WARNING:** Do not hand launch or hand land during windy days, when flying at night, or extreme environmental conditions as serious injury and/or damage may occur.

### Step 1 - Position Skydio X10D above a clear area so that you can move underneath it

Ensure the drone is facing away from you and extend your arm away from your body.

- The sensor package should face away from your body
- The back of the chassis and the battery are closest to you

### Step 2 - Initiate landing

Skydio X10D will descend vertically with full obstacle avoidance until it is 10 ft (3 m) above the ground.

Once your drone is below 10 ft (3 m), the lights on the drone turn yellow to indicate obstacle avoidance is disabled for the remainder of the landing.



**WARNING:** Do not attempt to grab or catch Skydio X10D without initiating a landing, the motors will continue to spin at full speed and may cause severe injury. Do not attempt to hand land until the lights turn yellow. Attempting to hand land while obstacle avoidance is active will cause it to attempt to avoid your hand and may result in Skydio impacting yourself or another nearby object.

### **Step 3 - Lightly grab the drone by the battery from underneath as it touches down on your open palm**

Once the battery has made contact with your palm, keep your hand steady until the propellers completely stop spinning.

#### **Do not attempt a hand landing if:**

- There are high winds present.
- Skydio X10D is not stable in flight for any reason.
- Skydio X10D is performing an emergency landing after an accident or crash.
- You are in an area where you do not have stable footing.
- You are on a moving vehicle or boat.
- Skydio X10D is in Low Light mode, with or without NightSense.

# Hot Sensor Package



**WARNING:** After prolonged use of the flashlight, your sensor package may be hot to the touch and could present a serious burn risk. After landing, wait for your sensor package to cool down before handling.

If you have the VT300-L sensor package and use the flashlight for an extended period of time, the sensor package may be hot to the touch after flight and could present a serious burn risk. If the flashlight is used for the duration of a flight in ambient temperatures of 100°F (38°C), the sensor package can reach temperatures up to 142°C (61°C).

Monitor your controller for any safety notifications and be careful when handling the sensor package after flight.





# Postflight

Learn how to access media and properly store your drone.

**This section covers**

---

Offloading Media

---

Stowing Skydio X10D

---

# Offloading Media

Select the **Media** menu within **Global Settings** to view photos, videos and scans from your recent flights.

- Select an image or video to view
- Press and hold on a thumbnail to select multiple or delete

If you captured photos using **Interval**, all photos captured will appear as a single stack. Selecting the stack will allow you to scroll through individual images one by one.

Only standard color and thermal JPGs will display in the Media menu. To access your DNG or RJPG files, you must transfer the files from your drone.



**NOTE:** *Media is not accessible inflight.*

Screen recordings and Screen captures are stored and managed in the Recording and Screenshot tab

- Screen captures can be exported to a USB-C drive from the controller
- Select the screenshot or recording to export
- Select Export > Done to move the file to an external USB-C drive
- Wait at least 30 seconds before ejecting the memory drive to ensure the media exported.

### Transferring Media

**Step 1 - Power on Skydio X10D**

**Step 2 - Connect X10D to your computer**

Insert the provided USB-C cable into the USB-C charging port on the back of your drone.

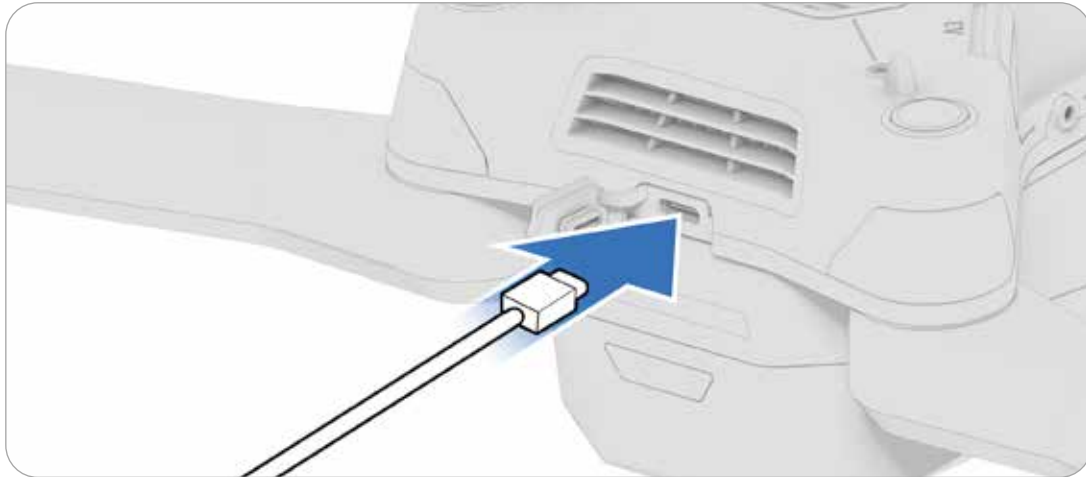

**Step 3 - Import your media**

If you are using an Apple product, use the Photos app or the Image Capture app to transfer your files.

# Stowing Skydio X10D

## Step 1 - Wait for postflight tasks to complete

If the battery is low while performing a longer postflight task, such as Onboard Modeling with Map Capture, ensure the drone is plugged into a power source.

- Powering off or removing the battery during postflight tasks will result in loss of data

## Step 2 - Power off Skydio X10D and the X10D controller

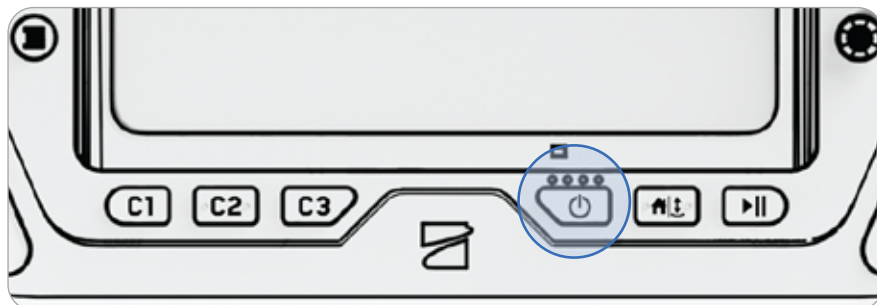
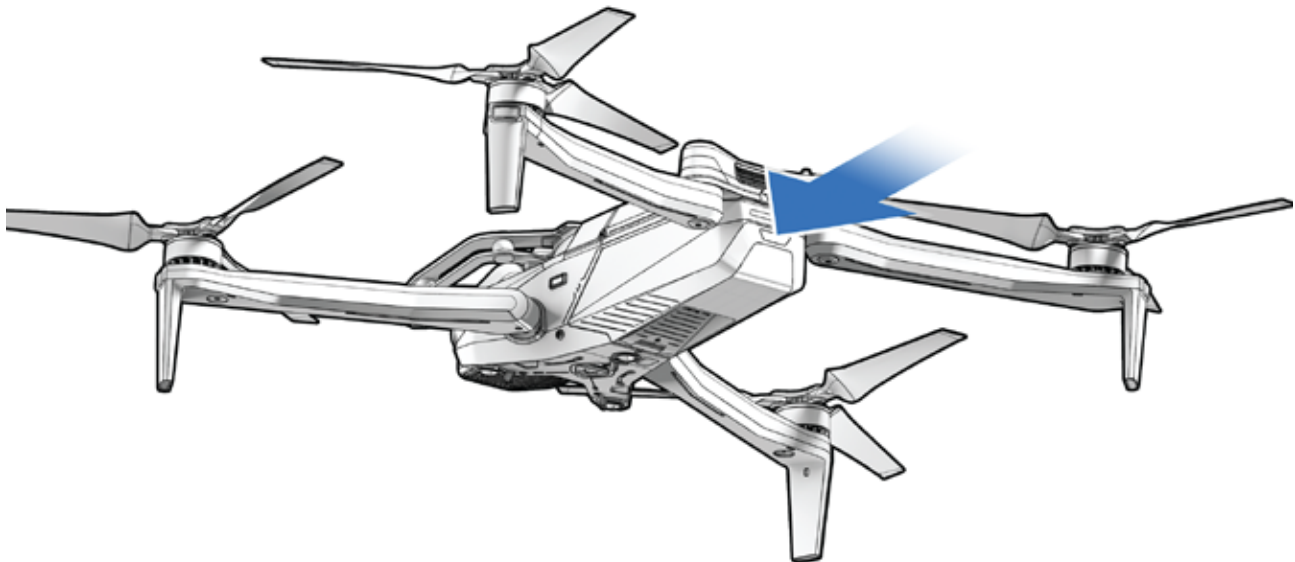

## Postflight

---

### Step 2 - Fold in the front arms

Hold the drone with the sensor package facing away from you. Gently pull the arm toward the back of the drone and rotate until it is tucked into place.

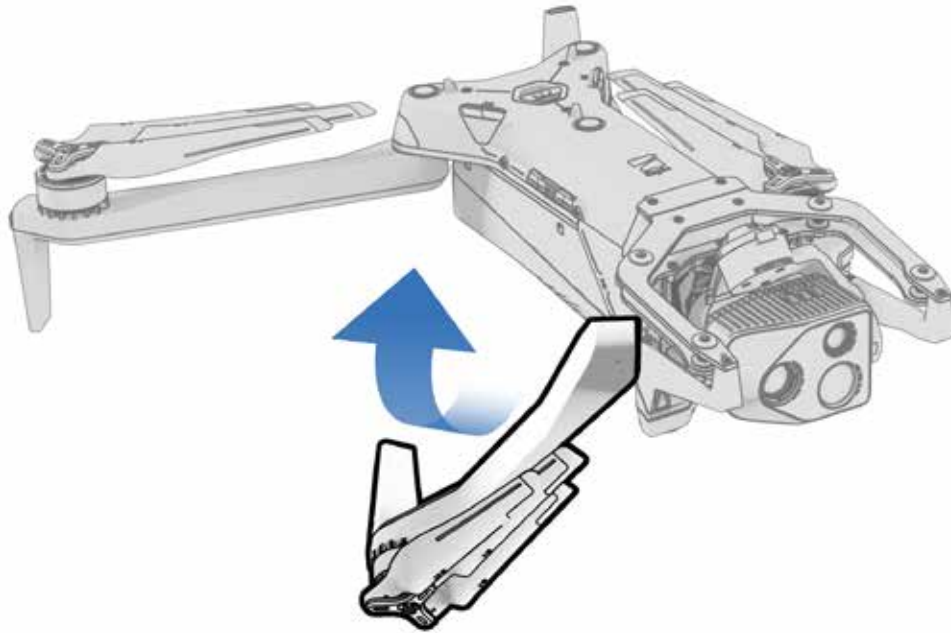

### Step 3 - Fold in the rear arms

Push laterally toward the chassis. Gently continue until you meet resistance.

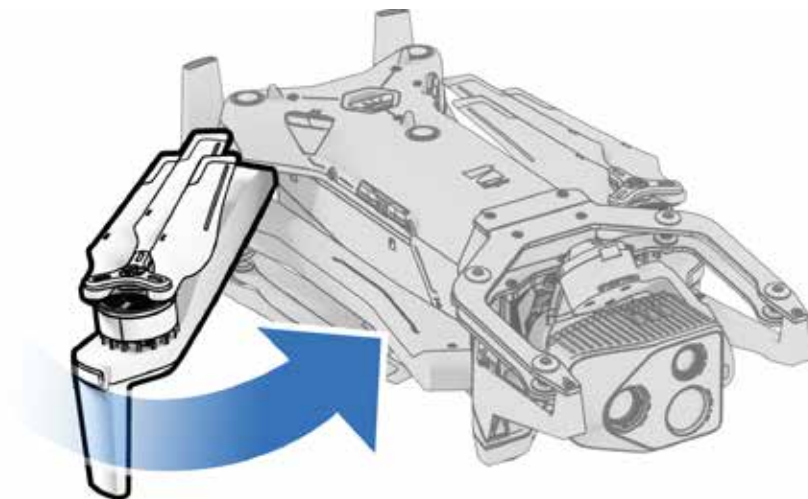

## Postflight

---

### Step 4 - Attach the sensor package lock

Hold the sensor package and gently reattach the lock to the top of your drone.

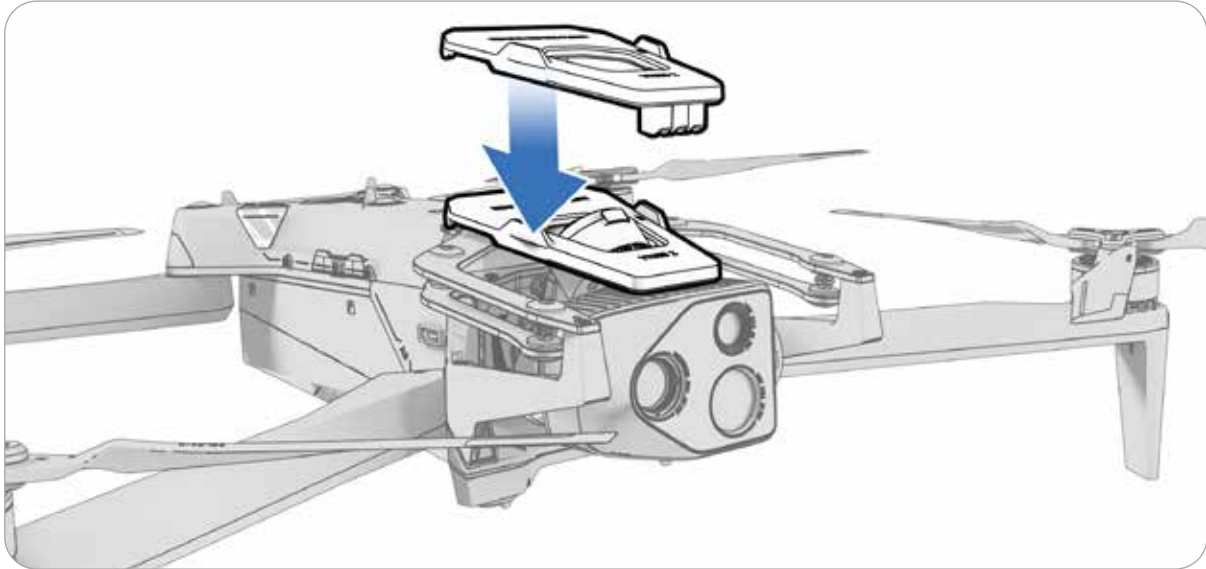

**NOTE:** Refer to the *Flying in Precipitation* section above for steps on how to properly store your drone after flight in precipitation.

### Step 5 - Stow system in the hardshell case for transportation

As demonstrated on page 10.



# Contingency Behaviors

Learn about the behaviors during events such as lost connection or low battery. Always monitor Skydio Flight Deck for alerts.

## This section covers

---

Low Battery

---

Lost Connection

---

Lost GPS and Attitude Mode

---

Flight Termination

---

Controller Overheating

---

# Low Battery



**WARNING:** While flying, always monitor Skydio Flight Deck for in-app alerts relating to battery levels, signal quality and other inflight notifications. You may only choose to cancel an automated landing at your own sole risk—you are responsible for the potential loss of the drone and/or serious bodily harm and property damage.

The Battery Indicator dynamically updates during flight based on weather, altitude, payload attachment weight, and distance from the return location. Monitor the indicator while flying to understand how much battery is:

- Available for flight
- Required for return
- Required to land

Skydio X10D will assess the altitude and distance from the Launch or Home Point and alert you when it is time to return and land.

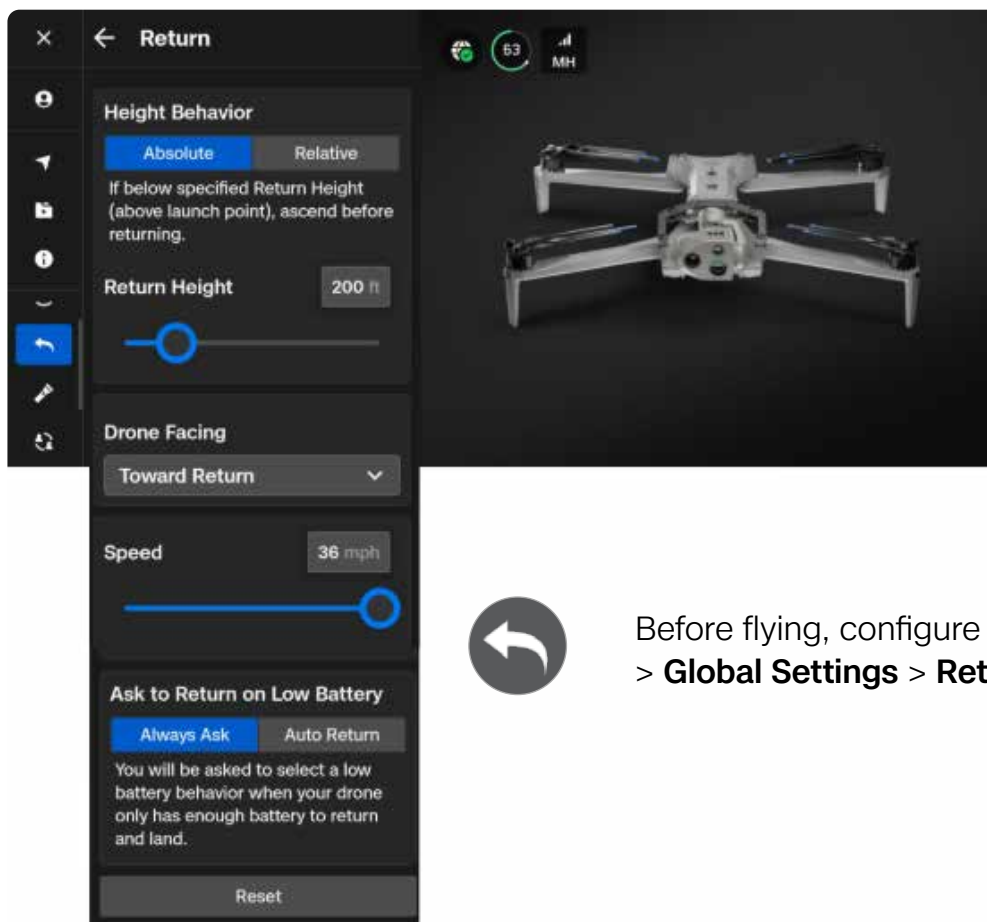

Before flying, configure return settings  
> **Global Settings** > **Return**

# Low Battery

A series of alert notifications will display depending on the charge level remaining.

**Return Battery Capacity Reached:** The drone only has enough battery to return and land. This is based on conditions such as weather or attachment usage. If you delay your return, you may not have sufficient battery power to reach the return point.

- An audible tone will play over the X10 Controller
- If the drone is within 32 ft (10 m) of the return location, it will begin returning without displaying this notification
- If you selected **Ask to Return** (default) in your Return settings, you will be prompted to choose **Return** or **Keep Flying**
- If you selected **Auto Return on Low Battery** in your Return settings, the drone will begin returning automatically. Select OK in the notification to dismiss the notification but not cancel the return
- If no Home Point is set, the drone will return to the Launch Point



*Ask to Return (default)*

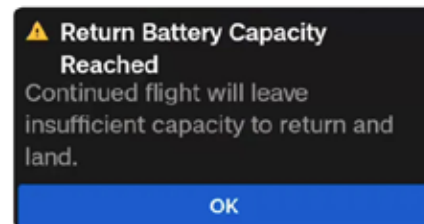

*Auto Return on Low Battery*

**Land Soon:** The drone will continue flying and a notification will display one minute before the drone will begin to land in place. Autonomous actions, such as Waypoints, 3D Scan, or Subject Tracking, are disabled. You may choose to continue flying, however, it is strongly recommended that you fly to a safe location and land soon.

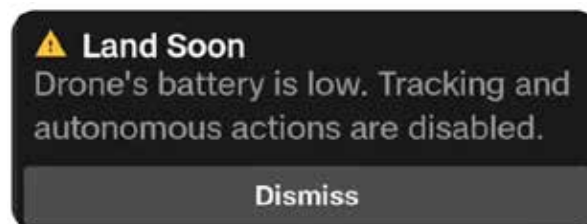

# Low Battery

**Drone Battery Low:** The battery level is too low to continue flying and the drone will begin looking for a clear and flat landing surface. The drone will land in place and may make minor adjustments to land in the flattest spot. You have the ability to make small, nudging adjustments. It will not return to any designated return location.

- An audible tone will play over the X10 Controller
- Select the sound icon within the notification to mute, or adjust all notifications using the Sound menu (Global Settings > Sound)

**Land Immediately:** The battery level is critically low and the drone may power off mid-flight without warning. The warning displays if the earlier Drone Battery Low automatic landing and continue flying is ignored. If the drone is descending toward an unsafe area (e.g., water, traffic), you may cancel the landing, move to a safer location, and then resume the landing process.

- A series of audible tones will play over the X10 Controller



**WARNING:** Continuing to fly greatly increases the risk of a crash, loss of the drone, or serious bodily harm or injury.

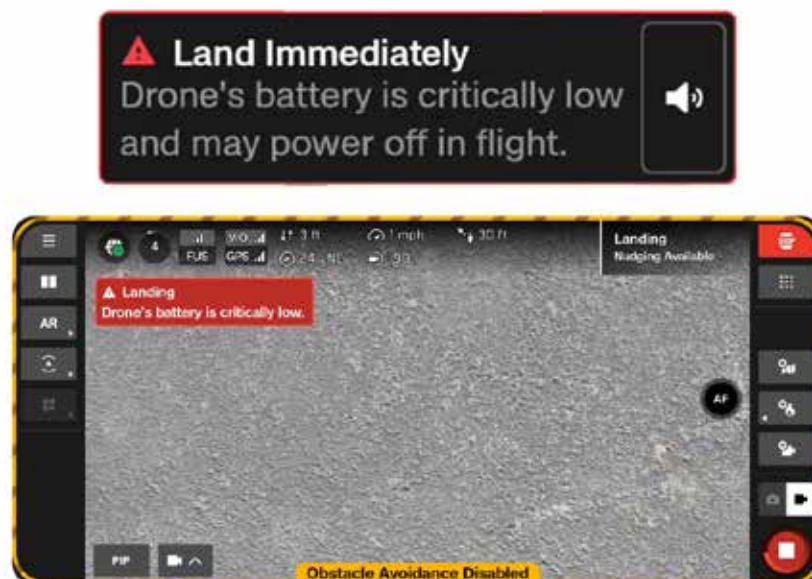

# Battery Capability Limitation

At times of reduced battery performance, extreme cold, extremely low battery level, overheating, and cell imbalance, the drone will reduce its top speed and acceleration in order to enhance safety:

- Max ascent speed: 2 m/s
- Max ground speed: 12 m/s

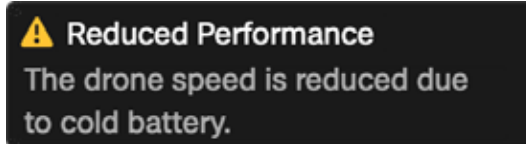

# Low Controller Battery

To ensure a safe and uninterrupted flight, monitor the controller battery levels. If the battery drops below 20%, an alert will display.

**Controller Battery Low:** Controller battery reaches 10%

**Controller Battery Critical:** Controller battery reaches 5%

- If the controller powers off, the drone will honor the configured Lost Connection behaviors
- An audible tone will play over the X10 Controller

# Lost Connection



**WARNING:** Before flying, ensure you have set your Lost Connection Return Behaviors. This is a critical step that ensures your drone returns safely and lands in an accessible location.

If connection is lost, Skydio X10D will default to the **Lost Connection** settings. Select between **Return** (default) and **Hover** upon lost connection.

## Return (default)

**Wait Before Return** - set the amount of time you want Skydio X10D to wait before it initiates a return flight, allowing time to reconnect

**Land After Return** - when enabled, your drone will return, hover for a specified amount of time, then land.

**Wait Before Land** - the amount of time between 0 to 300 seconds (default is 240 seconds) that you want your drone to wait above the landing location before landing. This setting is only enabled when Land After Return is toggled on.

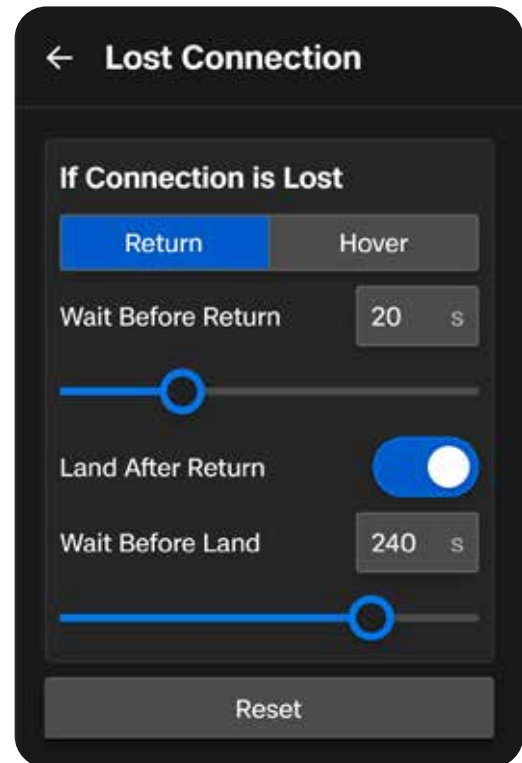

Scan for more information about Contingency Behaviors.

### Hover

**Land After Hover** - when enabled, Skydio X10D will hover for a specified amount of time, then use visual navigation to find a safe area to land.

**Wait Before Land** - the amount of time between 0 to 300 seconds (default is 240 seconds) that you want your drone to wait before landing. This setting is only enabled when Land After Hover is toggled on.

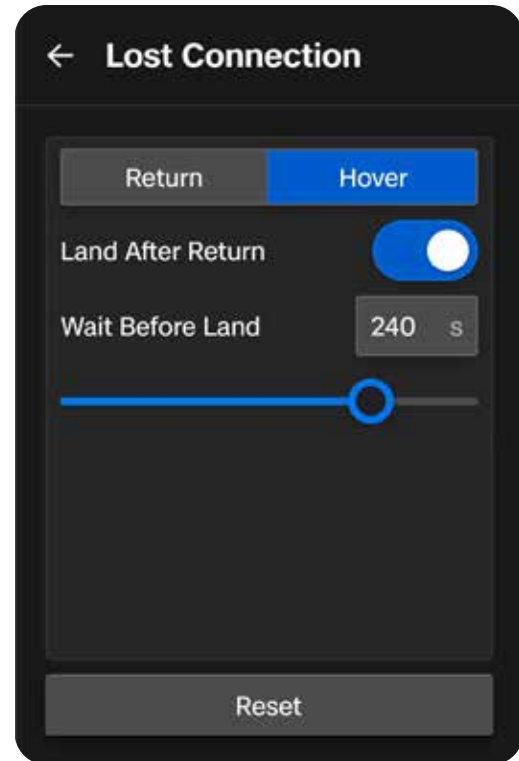

Skydio X10D will continue hovering as it tries to regain connection. If it fails to reconnect and reaches low battery:

- If you have an automatic return set, your drone will return to either the Launch Point or Home Point (if set)
- If you do not have an automatic return set, your drone will use visual navigation to find a safe area to land
- If you do not have strong VIO (e.g. you are flying in Low Light mode without NightSense), your drone will be unable to use visual navigation and will descend vertically and land

# Lost GPS and Attitude Mode

If Skydio X10D loses GPS signal, the drone will continue flying using the vision system. Actions that require GPS will be disabled.

If visual navigation (VIO) is also unavailable, the drone will enter Attitude Mode, a mode of flying that relies on the drone barometer to maintain altitude. By default, if there are no joystick inputs for 5 seconds, the drone will begin emergency landing.



**NOTE:** Monitor your GPS and VIO health in the telemetry bar. If VIO and GPS both drop below 2 bars of health, your drone will enter Attitude Mode.

In this mode, the drone will use internal barometer readings to maintain altitude when the throttle joystick is centered.

The drone will drift, in which case you will need to adjust roll and pitch movements to maintain the drone's position. The drone will not automatically hold position or automatically brake when the joysticks are centered.



**CAUTION:** Obstacle Avoidance is not available in attitude mode.

## Contingency Behaviors

If the drone regains GPS and/or VIO while in Attitude Mode, it will switch out of Attitude Mode and use whichever navigation system is strongest.

- To have the best chance of recovering VIO, descend below approximately 60 feet above the ground and fly within sight of visual features.
- When GPS becomes available again, a prompt will be displayed. Fly the drone horizontally (either left and right, or back and forth) to regain GPS heading and resume GPS navigation.

Navigate to **Global Settings** > **Flight Controls** > **Landing** to configure landing behavior while in attitude mode.

### Land in Attitude Mode

**Toggled On (default)** - After 5 seconds of inactivity in Attitude Mode (i.e. the joysticks are centered and not touched), Skydio X10D will automatically initiate an emergency landing.

**Toggled Off** - The drone will remain in attitude mode indefinitely under user control while no navigation sources are healthy.

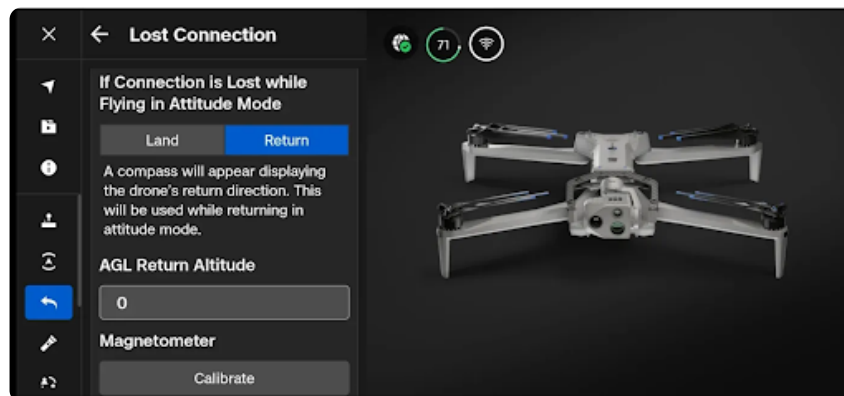

After 5 seconds of inactivity in Attitude Mode (i.e. the joysticks are centered and not touched in a neutral position and not engaged), Skydio X10D will automatically initiate an emergency landing and descend autonomously. An alert notification will display that Skydio X10D is initiating an emergency landing. If you input any joystick command while the drone is emergency landing, it will stop descending landing and you can continue to fly in Attitude Mode.

### Return in Attitude Mode

Your X10D returns using a compass to assign a heading by autonomously flying in an operator-defined direction when navigation and communication are lost.

- Set the return altitude AGL taking the terrain into consideration
- Calibrate the magnetometer
- A compass will display on the fly screen the return heading. Manually adjust the compass to set return heading.

### **Low Battery in Attitude Mode**

The drone will not return or land automatically at low battery while flying in Attitude Mode. It is your responsibility to monitor battery level and manually fly the drone to a safe landing location and land the drone when the battery is low. When the battery is low and the throttle stick is centered, the drone will descend to remind you that it is time to land.

### **Lost Connection in Attitude Mode**

If you lose connection with the drone while flying in attitude mode, the drone will descend and emergency land in place.

### **Landing in Attitude Mode**

To land the drone in attitude mode, you can press or hold the Land button to autonomously descend and touch down, or you can manually descend and touch down. The drone will automatically disarm and spin down the propellers after a few seconds when it detects that the drone is safely on the ground and the throttle joystick is held in a full down position.

# Flight Termination



**WARNING:** Terminating a flight will cause your drone to crash. Damage resulting from Flight Termination is not covered under warranty and may result in injury or damage. Use only in extreme situations.

In the event of an extreme emergency, you have the option to immediately terminate your flight. **Simultaneously press and hold the C3 button and Launch/Return/Land button for three seconds** while in flight to immediately stop the motors.

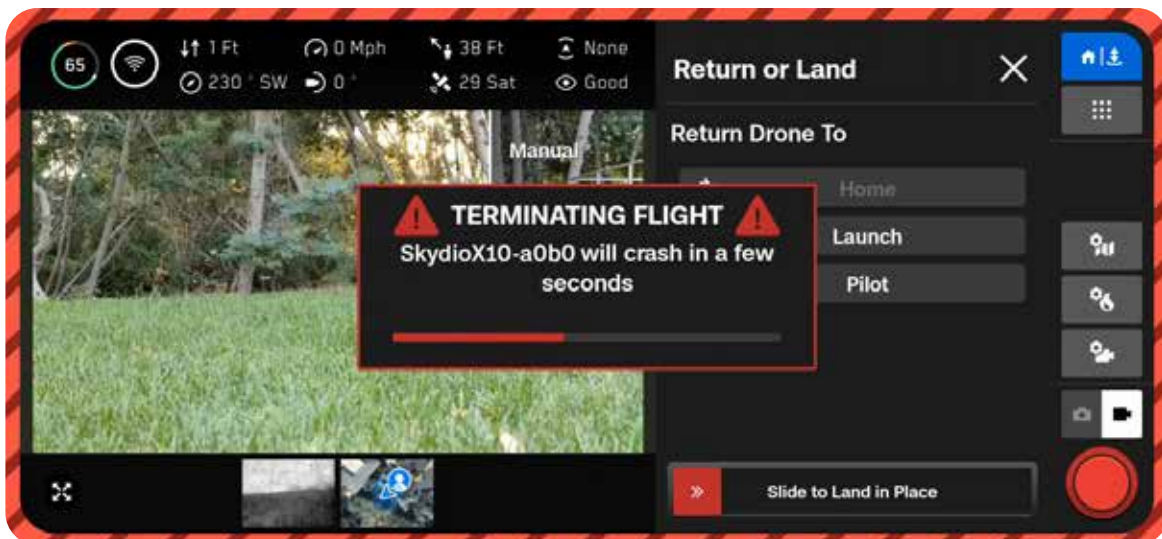

# Controller Overheating

If the Skydio X10D Controller reaches critical temperatures and overheats in flight, it will shut down and lose connection to the drone, triggering the X10D Lost Connection behavior.



To mitigate overheating and reduce the risk of lost connection during flight, the controller will issue two alerts and provide guidance to the operator.

Alert	Operator Action
<b>Controller is Heating Up</b>	Take mitigation actions: <ul style="list-style-type: none"><li>• Move the controller screen out of direct sunlight</li><li>• Move to a shaded or cooler area if possible</li><li>• Continue flight - this alert is cancellable</li></ul>
<b>Controller Too Hot to Operate</b>	Take immediate action to land: <ul style="list-style-type: none"><li>• Launch will be prevented</li><li>• If the drone is in flight the signal between the controller and the X10D will be lost and your drone will default to the operator-defined lost connection settings</li><li>• This alert is non-cancellable</li></ul>



# Maintenance

Learn how to replace your propellers and best practices for battery and equipment storage.

## This section covers

---

Replacing Propellers

---

Cleaning Your System

---

System Lifespan

---

Battery Care

---

Maintenance Schedule

---

# Replacing Propellers

For optimal performance, Skydio recommends replacing your propellers **after 250 hours of flight time** or whenever you notice any damage.



**WARNING:** Propellers with hairline cracks or large breaks, chops, or bends should be replaced immediately. Do **NOT** fly Skydio X10D with propellers that are not in good condition as serious bodily harm or injury may occur.

## Step 1 - Remove old or damaged propeller set

Hold onto the motor with one hand and take the propeller hub in the other. Press down on the propeller hub and twist to release.

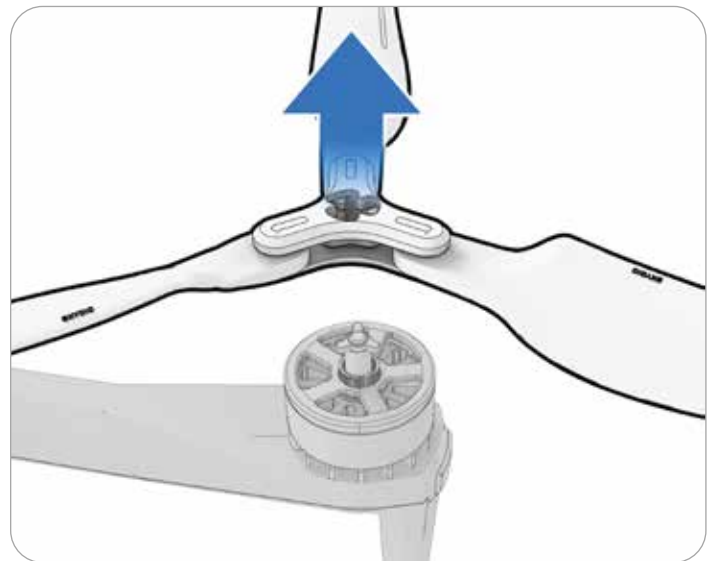

**NOTE:** You will need to twist either clockwise or counterclockwise depending on the motor.

## Maintenance

---

### Step 2 - Identify the propeller set that matches the motor

- Match the replacement set of propellers to the color on the motor.

### Step 3 - Inspect for any debris

Inspect the motor to ensure there is no dirt or debris.

### Step 4 - Install new propeller set

Hold onto the motor with one hand and take the propeller hub in the other. Flip the propeller hub so the opening on the hub aligns with the the motor. Press down and twist to lock in place.

Be gentle and do not force the fitment. If the propeller set does not fit on the motor it might be the incorrect set or side.

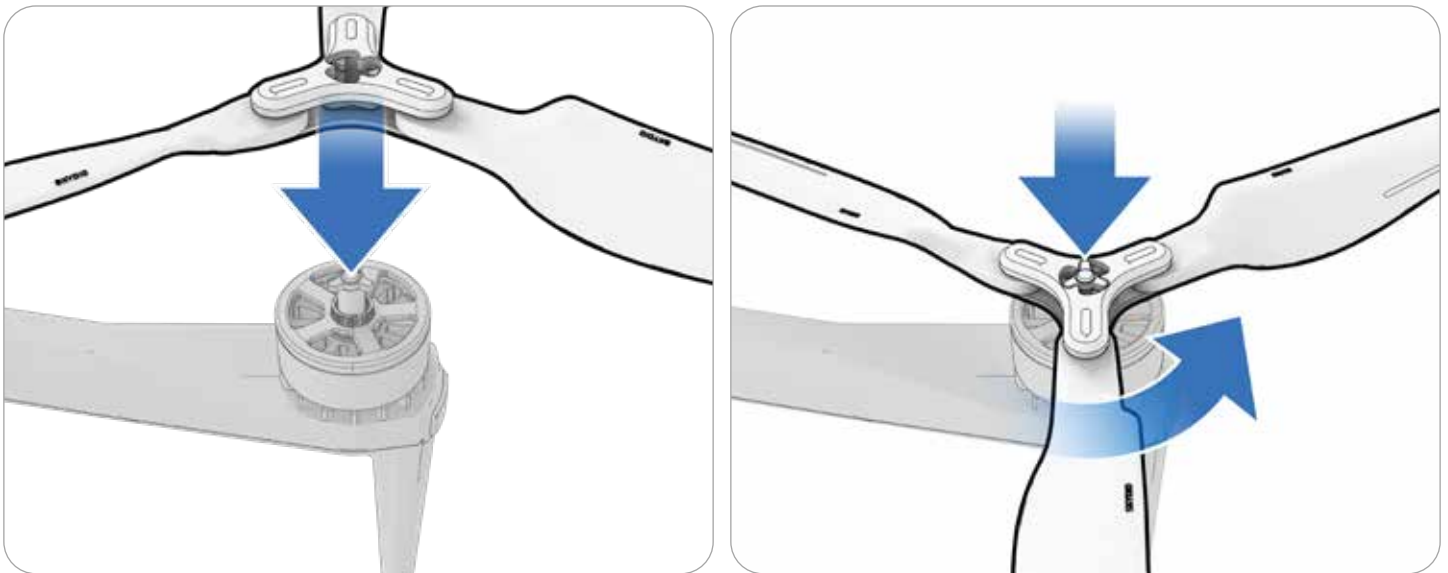

**NOTE:** You will need to twist either clockwise or counterclockwise depending on the motor.

# Cleaning Your System

It is recommended to wipe down your drone after flights in environments with significant dust or debris.



**WARNING:** Do not submerge your drone or batteries or place them under running water. Water volumes from flight in precipitation are much lower than those from a faucet or hose. Water may get into areas where the drone is not designed to withstand and you may compromise the sensors.

- Wipe down your drone with a dry or water-damp microfiber cleaning cloth.
- Only use lens cleaner on cameras.
- Do not submerge your drone or batteries.
- Do not place your drone or batteries under running water.
- Use a compressed air canister to remove any debris in hard to reach areas.
- If needed, mild soap and water may be used to remove heavier dirt or debris. Avoid getting any soap near ingress areas on the drone.
- Keep all the drain holes on the drone and battery clear. If any debris is blocking a drain hole (e.g., mud), use compressed air or gently scrape with a toothpick to remove.

# Storage

- Do not store Skydio X10D while wet. After flying in precipitation, allow the drone to air dry in a dry, temperature-controlled environment before stowing. Visit the **Flying in Precipitation** section of this manual for more information.
- Store batteries at room temperature 71°F - 82°F (22°C - 28°C) for optimal performance and longevity.
- Store batteries in a cool, dry area with less than 75% relative humidity. Do not store your batteries in extreme environmental conditions.
- Batteries in an idle state (14 days of idle time with no flights) will start to self-discharge in an effort to retain capacity. This may take several days to complete and it is normal for the battery to be slightly warm during this discharge process.

# Export Logs

To retrieve full system logs from offline devices using a USB-C drive, for troubleshooting and issue resolution.

- Insert a USB-C memory drive into the rear port on the X10D vehicle
- Ensure a USB-C memory drive is formatted to EXFAT
- Navigate to Global Settings > Vehicle > Export Vehicle Logs to USB-C
- The drone lights will breathe yellow to indicate an active log transfer
- Vehicle Log Export message will display the percentage of export
- When export is complete, the message Copying vehicle logs to USB complete will display
- Remove the drive from the drone and insert into a device to access the log files

# Maintenance Schedule

To optimize the performance of your Skydio X10D it's important to keep your drone updated, inspect your equipment, store your equipment properly, and occasionally replace your propellers and batteries.

Action	Interval
Update system	When an update is available (per your organization's guidelines).
Clean drone navigation cameras	Before each operational session, and after sessions in dust or precipitation. If flying in areas with high amounts of dust or debris, you may be prompted to clean your camera lenses before each flight.
Replace propellers	Per 250 hours of flight time
Replace battery	After 300 battery cycles <ul style="list-style-type: none"><li>• A battery cycle is the depletion of at least 80% of the charge.</li><li>• An undamaged and properly stored battery can be safely used beyond 300 cycles.</li></ul>

***Scan the QR code for the complete Skydio X10D Maintenance Manual***





# Specifications

**This section covers**

---

Skydio X10D

---

Skydio X10D Controller

---

Sensor Packages

---

Navigation Camera System

---

Flight Battery

---

System Security

---

Skydio X10D Dual Charger and Power Supplies

---

## X10D Drone

<b>Dimensions fully deployed</b>	31.1 x 25.6 x 5.7 in / 79 x 65 x 14.5 cm
<b>Dimensions (folded, no battery)</b>	13.75 x 6.5 x 4.7 in / 35 x 16.5 x 11.9 cm
<b>Weight (incl. batteries)</b>	4.72 lb / 2.14 kg
<b>Max Launch Weight</b>	5.49 lb / 2.49 kg
<b>Operation Frequency</b>	MicroHard 1790-1850 MHz 2040-2110 MHz 2200-2300 MHz 2300-2390 MHz 2400-2500 MHz
<b>Transmitter Power (EIRP)</b>	38 dBm
<b>Hovering Accuracy (windless or breezy)</b>	VIO: +/- 10 cm GNSS: +/- 1 m
<b>Max Angular Velocity</b>	Yaw: 100° /s Roll and Pitch: 225° /s
<b>Max Tilt Angle</b>	40°
<b>Max Ascent Speed</b>	13.4 mph / 22 km/h
<b>Max Descent Speed</b>	9 mph / 14.5 km/h
<b>Max Non-Vertical Descent Speed</b>	13.4 mph / 21.5 km/h
<b>Max Horizontal Speed (at sea level)</b>	45 mph / 72 km/h
<b>Max Horizontal Speed with Obstacle Avoidance</b>	36 mph / 58 km/h
<b>Max Service Ceiling Above Sea Level</b>	15,000 ft / 4572 m density altitude
<b>Max Gust Handling</b>	28 mph / 45 km/h
<b>Max Hover Time</b>	35 minutes
<b>Max Flight Time</b>	40 minutes
<b>Processors</b>	NVIDIA Jetson Orin SoC Qualcomm QRB5165 SoC
<b>Ingress Protection Rating</b>	IP55
<b>GNSS</b>	GPS + Galileo + GLONASS + BeiDou
<b>Operational Temperature Range</b>	-4° to 113°F / -20° to +45°C
<b>Obstacle Avoidance Coverage</b>	True 360°

# Specifications

## X10D Controller

<b>Dimensions closed</b>	10 x 5 x 3 in / 25.4 x 12.7 x 7.6 cm
<b>Dimensions open</b>	10 x 9 x 3 in / 25.4 x 22.8 x 7.6 cm
<b>Dimensions screen</b>	6.6 in / 16.7 cm
<b>Screen</b>	Dynamic AMOLED touchscreen 120 Hz Adaptive Refresh Rate Resolution: 2340 x 1080 pixels Brightness: 1750 nits (outdoor peak) 392 ppi
<b>Weight</b>	2.5 lb / 1135 g
<b>Operation Frequency</b>	Multiband
<b>Max Range</b>	up to 10 km
<b>Transmitter Power (EIRP)</b>	38 dBm
<b>Ingress Protection Rating</b>	IP54
<b>Operating time</b>	5 hours
<b>Battery</b>	9600 mAh
<b>GNSS</b>	GPS + Galileo + GLONASS + BeiDou
<b>Operational Temperature Range</b>	-4° to 113°F / -20° to +45°C
<b>Wired outputs</b>	HDMI & USB-C
<b>Security</b>	NDAA compliant AES-256 encrypted data link Encrypted internal disk storage Password protected Root of trust Trusted boot Secure update

## Specifications

---

### VT300-Z Sensor Package

Angular Vibration Range	+/-0.01°
User Controllable Range	+/-90° pitch
Mechanical Range	+/-140° pitch, +/-90° yaw, +75° to -230° roll

### VT300-L Sensor Package

Angular Vibration Range	+/-0.01°
User Controllable Range	+/-90° pitch
Mechanical Range	+/-140° pitch, +/-90° yaw, +75° to -230° roll
Flashlight Illumination	22 lux at 3 meters

### Telephoto Camera (VT300-Z only)

Sensor	1/2" 48MP CMOS
Diagonal Field of View	13°
Focal Length	35 mm (190 mm equivalent)
Aperture	f/2.2
Focus	hybrid PDAF, 5 m to ∞
Exposure Compensation	+ -3
Electronic Shutter Speed	1/30 to 1/8000
ISO Range	100 to 16000
Max Video Resolution	3840 x 2880
Max Photo Size	8000 x 6000

### Wide Camera (VT300-L only)

<b>Sensor</b>	IMX989 1" 50.3MP CMOS
<b>Diagonal Field of View</b>	93°
<b>Focal Length</b>	8 mm (20 mm equivalent)
<b>Aperture</b>	f/1.95
<b>Focus</b>	100% focus pixel, 1 m to ∞
<b>Exposure Compensation</b>	+/-3
<b>Electronic Shutter Speed</b>	1/30 to 1/8000
<b>ISO Range</b>	100 to 16000
<b>Max Video Resolution</b>	3840 x 2880
<b>Max Photo Size</b>	8192 x 6144

### Narrow Camera (VT300-Z and VT300-L)

<b>Sensor</b>	1/1.7" 64 MP CMOS
<b>Diagonal Field of View</b>	50°
<b>Focal Length</b>	10 mm (46 mm equivalent)
<b>Aperture</b>	f/1.8
<b>Focus</b>	hybrid PDAF, 1 m to ∞
<b>Exposure Compensation</b>	+/-3
<b>Electronic Shutter Speed</b>	1/30 to 1/8000
<b>ISO Range</b>	100 to 16000
<b>Max Video Resolution</b>	3840 x 2880
<b>Max Photo Size</b>	9248 x 6944

### Thermal Camera (VT300-Z and VT300-L)

<b>Thermal Imager</b>	Flir Boson+ Uncooled VOx Microbolometer
<b>Diagonal Field of View</b>	41°
<b>Focal Length</b>	13.6 mm (60 mm equivalent)
<b>Aperture</b>	f/1.0
<b>Focus</b>	5 m to ∞
<b>Thermal Sensitivity</b>	<30mK NEDT
<b>Infrared Temperature Measurement Accuracy</b>	Larger of +- 5°C or 5%
<b>Image Processing</b>	Adreno 650 GPU accelerated ISP pipeline
<b>Max Video Resolution</b>	640 x 512
<b>Photo Size</b>	640 x 512
<b>Photo Format</b>	JPEG, RJPEG
<b>Pixel Pitch</b>	12 um
<b>Temperature Measurement Method</b>	Spot Meter, Region of Interest
<b>Temperature Measurement Range</b>	-40° to 150° C (-40° to 350° C low gain)
<b>Palette</b>	White hot Black hot Ironbow Rainbow

### Vision Systems / Navigation Cameras

<b>Configuration</b>	6x cameras in trinocular configuration top and bottom
<b>Sensor</b>	Samsung 1/2.8" 32 MP color CMOS
<b>Light Sensitivity</b>	Visible Light
<b>Aperture</b>	f/1.8
<b>Diagonal Field of View</b>	200°
<b>Obstacle Sensing Range</b>	20 meters
<b>Environment Coverage</b>	True 360°

### System Security

<b>Wireless Encryption</b>	Connect SL: AES-256
<b>NDAA Compliance</b>	NDAA Compliant
<b>Root of Trust</b>	HSM protected keys
<b>System Integrity</b>	Secure boot
<b>Secure Update</b>	AES-256 encrypted, signed, & verified
<b>Internal Disk Storage</b>	Encrypted
<b>SD Cards</b>	Unencrypted
<b>Pairing</b>	Secure wired pairing

### Flight Battery SBR47V1

<b>Capacity</b>	8419 mAh
<b>Voltage</b>	18.55 V
<b>Battery Type</b>	Rechargeable Lithium Ion Polymer
<b>Energy</b>	156.17 Wh
<b>Net Weight</b>	1.56 lb +/- 0.003 lb
<b>Operational Temperature Range</b>	-20° to 60°C
<b>Storage Temperature Range</b>	-20° to +45°C (storage less than 3 months)
<b>Charging Temperature Range</b>	5° to 45°C
<b>Chemical System</b>	Lithium Ion Polymer

### Flight Battery SBR47V2

<b>Capacity</b>	8800 mAh
<b>Voltage</b>	17.5 V
<b>Battery Type</b>	Rechargeable Lithium Ion Polymer
<b>Energy</b>	154 Wh
<b>Net Weight</b>	685g / 1.51 lb
<b>Operational Temperature Range</b>	-20° to 60°C
<b>Storage Temperature Range</b>	-20° to +45°C (storage less than 3 months)
<b>Charging Temperature Range</b>	5° to 45°C
<b>Chemical System</b>	Lithium Ion

## Specifications

---

### X10D Dual Charger and Power Supplies

<b>Dimensions</b>	180 x 75 x 48 mm
<b>Weight (w/o Battery)</b>	0.73 lb
<b>Charge Time 230 W barrel jack</b>	1 hour (0-100%)
<b>Charge Time 100 W USB-C</b>	1 hour 45 minutes (0-100%)
<b>Weatherproofing</b>	No ingress protection
<b>Power input (100 W USB-C)</b>	5 VDC, 3 A / 20 VDC, 5A (USB PD)
<b>Power input (230 W barrel jack)</b>	20 VDC, 11.5 A



# Legal

**This section covers**

---

Safety

---

Battery

---

Skydio One (1) Year Limited Warranty

---

Skydio Care

---

California Prop 65 Warnings

---

FCC Compliance Statement

---

FAA Compliance Statement

---

## Legal

---

Before operating Skydio X10D, review the *Getting Started* information including the *Operator Manual* available at [www.skydio.com/manuals](http://www.skydio.com/manuals). Retain documentation for future reference.

### **Safety**

Review the *Skydio Safety and Operating Guide* available at [www.skydio.com/safety](http://www.skydio.com/safety).

### **Battery**

Handle the battery with extreme care and refer to the Operator Manual and to the *Skydio Safety and Operating Guide* for additional information.

Danger of explosion if battery is incorrectly replaced. Replace only with the same or equivalent type recommended by the equipment manufacturer. Carefully dispose of batteries according to manufacturer's instructions and to your local environmental laws and guidelines.

Risque d'explosion si la batterie n'est pas correctement remplacée. Remplacer uniquement par un type identique ou équivalent recommandé par le fabricant de l'équipement. Jeter les batteries conformément aux instructions du fabricant et aux lois et directives environnementales locales.

### **Charging**

Do not use the X10D Dual Charger near wet locations. To avoid the risk of electric shock, use only in dry locations. Do not allow anything to rest on the power cord. Do not locate this device where the cord will be abused by persons working on it. Do not overload wall outlets and extension cords as this can result in fire or electric shock.

N'utiliser pas le X10D Dual Charger à proximité d'endroits humides. Pour éviter tout risque de choc électrique, utiliser uniquement dans des endroits secs. Ne laisser rien reposer sur le cordon d'alimentation. Ne placer pas ce moniteur dans un endroit où le cordon pourrait être maltraité par les personnes travaillant dessus. Ne surcharger pas les prises murales et les rallonges car cela pourrait provoquer un incendie ou un choc électrique.

### **Skydio One (1) Year Limited Warranty**

Skydio warrants the included hardware product against defects in materials and workmanship in hardware under normal use in accordance with published guidelines including but not limited to the *Terms of Use*, *Operator Manual* and the *Skydio Safety and Operating Guide* for one year from the date of delivery (the “Limited Warranty”). The Limited Warranty does not warrant against normal wear and tear or damage caused by accident or abuse and is not applicable to any software provided with the hardware product. The Limited Warranty is subject to the full terms and detailed information about how to obtain service available at [www.skydio.com/legal/limited-warranty](http://www.skydio.com/legal/limited-warranty). If you submit a valid claim under this Limited Warranty, Skydio will either repair, replace, or refund your hardware product at its sole discretion. You may be required to furnish proof of purchase details when making a claim under this Limited Warranty.

### **Skydio Care**

Skydio offers Skydio Care as a subscription service at an additional cost that provides protection from collisions, water damage, or lost drones which are not covered under the Limited Warranty. Skydio Care can be purchased as a one (1) year plan co-extensive with the Limited Warranty, or as a three (3) year plan, which includes a two (2) year extension to the one (1) year term of the Limited Warranty. Skydio Care is subject to the full terms and detailed information about how to obtain service available at <https://www.skydio.com/legal/skydio-care-terms-of-service>. If you submit a valid claim under Skydio Care, you may be eligible to purchase discounted drone replacements for otherwise uncovered damage or losses. The Skydio Care benefits are in addition to the rights provided under the Limited Warranty.

### **California Prop 65 Warnings**

Skydio X10D uses lithium-ion batteries. Exposure to lithium-ion, containing cobalt lithium nickel oxide, and nickel, is known to the State of California to cause cancer and birth defects, or other reproductive harm. For more information visit: [www.P65Warnings.ca.gov](http://www.P65Warnings.ca.gov).

Skydio X10D Controller contains chemicals including cadmium, which is known to the State of California to cause cancer and birth defects, or other reproductive harm. For more information visit: [www.P65Warnings.ca.gov](http://www.P65Warnings.ca.gov).

Skydio X10D Dual Charger contains chemicals including BPA and nickel, which are known to the State of California to cause cancer and birth defects, or other reproductive harm. For more information visit: [www.P65Warnings.ca.gov](http://www.P65Warnings.ca.gov).

### **FCC Compliance Statement**

These devices comply with Part 15 of the FCC Rules and with ISED Canada license-exempt RSS standard(s). Operation is subject to the following two conditions: (1) these devices may not cause harmful interference, and (2) these devices must accept any interference received, including interference that may cause undesired operation. This equipment should be operated with a minimum distance of 22 cm between the X10 antennas and your body.

Cet équipement doit être utilisé avec une distance minimale de 22 cm entre les antennes X10 et votre corps. Ces appareils sont conformes aux normes RSS exemptes de licence d'ISDE Canada. Leur fonctionnement est soumis aux deux conditions suivantes: (1) ces appareils ne doivent pas causer d'interférences nuisibles, et (2) ces appareils doivent accepter toutes interférences reçues, y compris les interférences susceptibles d'entraîner un fonctionnement indésirable.

Changes or modifications not expressly approved by Skydio could void the user's authority to operate these devices.

These devices have been tested and found to comply with the limits for a Class A digital device, pursuant to part 15 of the FCC Rules. These limits are designed to provide reasonable protection against harmful interference when these devices are operated in a commercial environment. These devices generate, use, and can radiate radio frequency energy and, if not installed and used in accordance with the Operator Manual and Safety and Operating Guide, may cause harmful interference to radio communications. Operation of these devices in a residential area is likely to cause harmful interference in which case the user will be required to correct the interference at his own expense.

This Class A digital apparatus complies with Canadian ICES-003.

Cet appareil numérique de classe A est conforme à la norme Canadienne NMB-003.

## Legal

---

### FAA Compliance Statement

Unless specifically exempt, this product complies with 14 CFR Part 89 regulations on Remote Identification per ASTM F3411-22a-RID-B and ASTM F3586-22.

### Software License

The *Skydio Software End-User License Agreement* available at [www.skydio.com/legal/eula](http://www.skydio.com/legal/eula) governs the use of any Skydio software that is pre-installed, downloaded, installed, or otherwise provided in connection with any included hardware.

### Additional Resources

For all the latest information about Skydio and our products visit: [www.skydio.com](http://www.skydio.com).

For Skydio legal information and product terms of use visit: [www.skydio.com/legal](http://www.skydio.com/legal).

Skydio products are protected by patents and trademarks, registered in the United States and other countries. For Skydio intellectual property information visit: [www.skydio.com/legal/ip](http://www.skydio.com/legal/ip).

© 2024 Skydio, Inc. All rights reserved. Skydio and the Skydio logo are trademarks of Skydio, Inc., registered in the United States and other countries.



*If you need assistance, please reach out to: [FedSupport@skydio.us](mailto:FedSupport@skydio.us)*

