

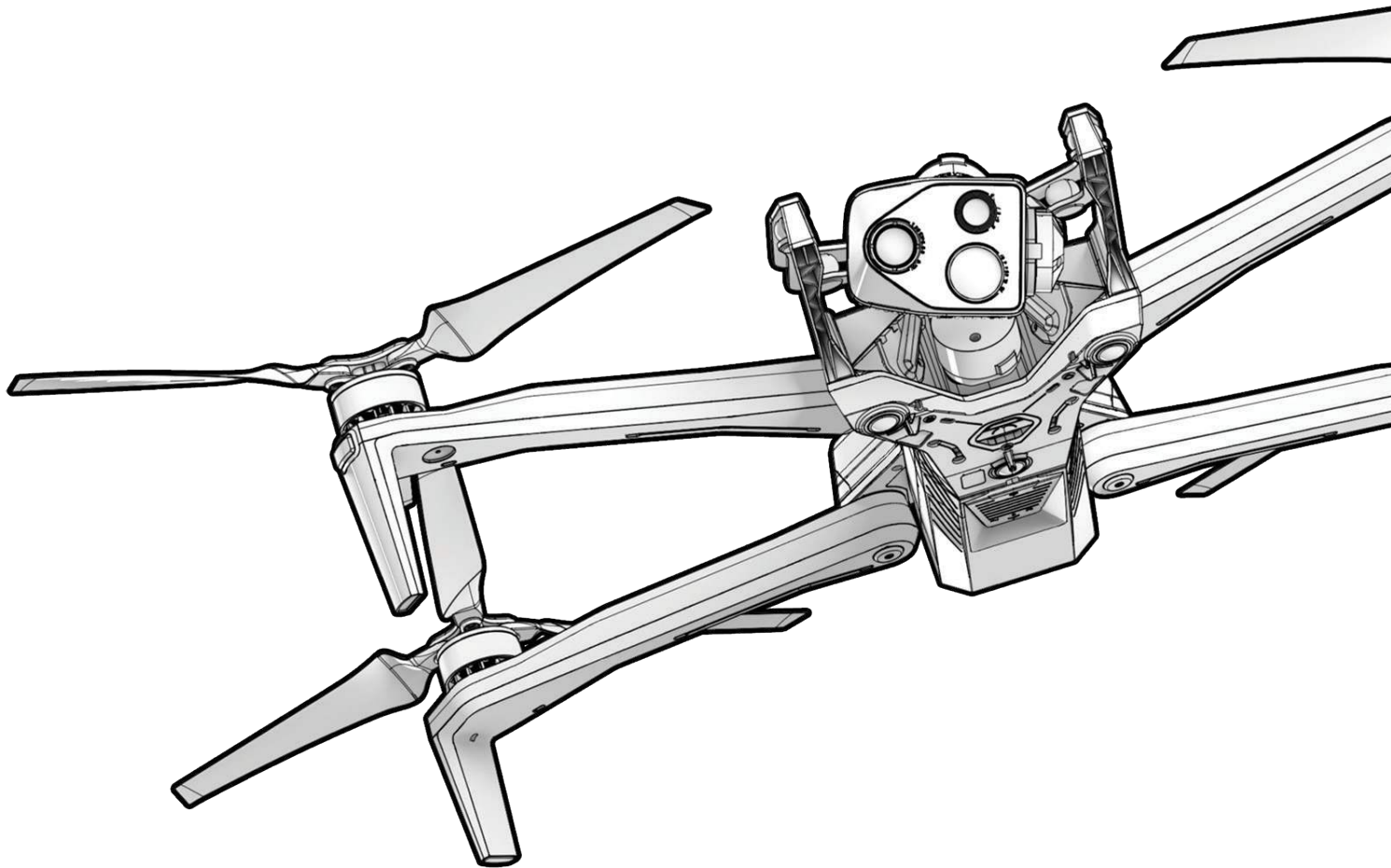

# Skydio X10

## Operator Manual





**WARNING:** Please read all documentation provided with your Skydio X10, including but not limited to the X10 Safety Guidelines in the Safety and Operating Guide: [www.skydio.com/safety](http://www.skydio.com/safety). Failure to follow any instructions or recommendations in our documentation may void the Skydio Limited Warranty.



**NOTE:** Skydio is not responsible for any loss, retention, or recovery of data resulting from the execution or non-execution of this Secure Data Erasure & Factory Reset procedure. The operator is solely responsible for ensuring that all required backups are completed and that each step of the checklist is properly performed and verified. Failure to follow the full procedure may result in residual data remaining on the aircraft, controller, or removable media. For more information, visit: [skydio.com/manuals](http://skydio.com/manuals)

# Revision History

Revision	Software Version and Description	Date
1	Initial Release	November 28, 2023
2	Documentation updates reflecting cumulative feature additions, interface enhancements, and performance improvements released between April 16, 2024 and May 7, 2025, prior to the introduction of standardized release version naming.	April 16, 2024 - May 7, 2025
3	<b>Controller version: Asmirov v39.186</b> <b>Drone version: Asimov v39.237</b> Updated to reflect new connectivity capabilities, enhanced navigation awareness, airspace alerting (ADS-B), high-altitude visual navigation, controller authentication improvements (SSO and multi-user support), image capture tools, and autonomous mission enhancements introduced in the Asimov release.	May 29, 2025
4	<b>Controller version: Battin v40.326</b> <b>Drone version: Battin v40.249</b> Updated to reflect mapping accuracy improvements, enhanced camera controls, new inflight awareness telemetry and alerts, expanded hardware/attachment support, and controller-based security workflows introduced in the Battin release.	September 3, 2025
4.1	<b>Controller app version: Battin v41.34.9</b> <b>Controller firmware version: Battin v40.328.1</b> <b>Drone version: Battin v40.249 (no change)</b> Updated to reflect controller interface enhancements, CAD incident marker support, streamlined Quick Action controls, and centralized sound settings introduced in the October 2025 controller update.	October 28, 2025
5	<b>Controller version: Cayley v44.79.14</b> <b>Drone version: Cayley v43.147.53</b> Updated to reflect 45 mph Fly Here Now speeds, advanced autonomy features such as Shadow Track and Follow and Backtrack, new Cloud-to-controller Map Capture planning, Cloud-managed encryption, and removal of the hand-wave calibration requirement for GPS night launches introduced in the Cayley release.	March 11, 2026

# Revision History

Revision	Software Version and Description	Date
6	Controller version: Cayley v44.79.14 Drone version: Cayley v43.147.55 Updated software versions.	March 18, 2026

# Additional Resources

For the latest information about Skydio and our products, visit: [www.skydio.com](http://www.skydio.com)

Scan the QR codes to view more information about flying with Skydio X10.



Getting Started with  
Skydio X10



Flying with  
Skydio X10



Skydio X10  
Maintenance



Skydio X10 Safety and  
Operating Guide



Skydio Support



Skydio Legal

For legal, warranty and intellectual property information, visit:  
[www.skydio.com/legal](http://www.skydio.com/legal)

# Table of Contents

## **Flying Safely** **01**

---

Safety Guidelines 01

## **How to Use this Manual** **08**

---

Overview 9

Flight Crew Roles 13

Key Concepts 14

## **Flight System Overview** **16**

---

Skydio X10 Starter Kit 17

Skydio X10 Starter Kit Case Layout 18

Skydio X10 Hardware 19

Skydio X10 Controller Hardware 21

Skydio X10 Overview and Autonomy 22

Charging Skydio X10 Batteries 29

Charging Skydio X10 Controller 34

Specifications 35

## **Flight System Initialization** **45**

---

Overview 46

Skydio Cloud Setup 47

Skydio X10 Setup 66

Skydio X10 Controller Setup 70

Connecting Devices 73

Updating Skydio X10 Controllers 75

Updating Skydio X10 77

Skydio Connect 5G Setup 80

Battery Warming in Cold Environments 81

Remote ID 83

ADS-B Alerts 84

## **Operations Planning** **87**

---

Overview	88
How to Import and View Custom Map Layers	89
Downloading Maps	95
Creating Waypoint Missions	96
Pre-planning and Syncing Map Capture Missions in Skydio Cloud	98

## **Preflight** **101**

---

Overview	102
Start of Shift Checklist	103
Preflight Checklist	106

## **Inflight Operations** **108**

---

Overview	110
Navigating Skydio Flight Deck	111
Camera Settings	171
Thermal Camera Settings and Tools	184
Launching	193
Flight Screen	197
Flight Skills	203
Dispatch: Viewing and Responding to Incidents	212
Flying at Night	215
Flying in Precipitation	226
Low Battery	236
Returning and Landing	241
Contingency Behaviors	246

## **Postflight** **255**

---

Overview	256
Postflight Inspection	257
FAA Accident Reporting Requirements	258
Offloading Media	259
Loggin out of X10 Controllers	261
Sending Skydio Support Logs	262
Stowing Skydio X10	269

## **Maintenance** **272**

---

Monitor X10 Drones and Batteries in Skydio Cloud	273
Updating the System	275
Replacing Propellers	276
Cleaning the System	278
Storage	279
Maintenance Schedule	280

## **Legal** **281**

---

# Safety Guidelines



**WARNING:** To avoid injury or damage to your drone, read the Skydio X10 Safety Guidelines in the Safety and Operating Guide.



Keep your fingers away from moving propellers at all times.



Use caution around reflective surfaces (e.g., still water or mirrors) and small obstacles (e.g., thin branches, utility lines, or chain link fencing)

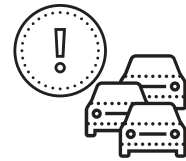

Skydio X10 does not avoid moving objects (e.g., vehicles).



Skydio X10 obstacle avoidance can be impaired when in low light and poor visibility when flying without NightSense. Fly with extreme caution under these conditions.



Before flying over water, ensure your drone has a strong GPS signal. Launch and land over a dry surface.



Skydio X10 is IP55 rated and able to fly in light to moderate precipitation with obstacle avoidance disabled. Skydio X10 Controller is IP54 rated.



Clean all of the cameras before each flight so Skydio X10 can see clearly.



Check your propeller blades for damage before each flight.



Follow all civil aviation authority regulations, as well as all local, state, and federal laws.

## Warnings

- Do not operate directly over people and vehicles without following all required regulations and garnering any required Certificates of Waiver or Authorization (COA).
- Fly with extreme caution and care around moving obstacles including but not limited to other aerial vehicles, cars, and/or animals.
- Skydio obstacle avoidance may be degraded around transparent or reflective surfaces, windows, mirrors, or still water greater than 23 in (58 cm) wide. Fly with caution.
- The pilot in command (PIC) is solely responsible for: a) managing altitude, range, and battery level and b) following all civil aviation authority regulations, as well as all local, state, and federal laws.
- Adhere to all in-app alerts, warnings, and recommendations such as landing in clear and safe areas.
- Propeller blades are sharp—handle with extreme caution and care especially when the propeller blades are spinning as serious injury and/or damage may occur.
- Obstacle avoidance is disabled during launching and landing. Exercise extreme caution and care to avoid injury and/or damage.
- When using the flashlight on the VT300-L sensor package, do not stare directly into the light at any range for any extended period of time.
- Ensure your landing area is flat, stable, and clear of obstacles.
- Skydio should not be used or handled by a person under the age of 16 years.
- Never fly near or interfere with crewed aircraft operations.
- Never fly under the influence of drugs or alcohol.
- Do not use artificial lighting to brighten the launch or landing zone during night flights. Enhancing illumination in a localized area, such as using vehicle headlights, can cause the drone to misinterpret ambient lighting conditions. This may result in a sudden transition into Attitude Mode after launching, increasing the risk of drift, loss of control, or cause serious bodily harm or injury. For safe night operations, follow best practices for Low Light flight and ensure the drone is prepared for consistent lighting conditions throughout the mission.
- You must maintain a distance of at least 10 ft (3 m) between Skydio X10 and emitters (including cell towers) to reduce the risk of electromagnetic interference (EMI). EMI may lead to camera failures, potentially impacting situational awareness of the remote pilot during operation. Disruptions to both controlled and autonomous flight may lead to a total loss of the vehicle and pose a risk of serious bodily injury.

## Preflight

- Skydio X10 navigates visually using cameras so it is essential to keep all of the cameras clean. Use the included microfiber cleaning cloth (or a similar type of microfiber cloth) to ensure camera lenses are free of dust and dirt before every flight.
- Ensure all propellers are firmly attached and free of nicks, cracks, or other visible damage. Never fly with damaged propellers.
- Keep your fingers away from spinning propellers at all times.
- Ensure all 4 arms are fully deployed prior to initiating flight. Failure to do so may result in unstable flight and/or a loss of control.
- Skydio X10 uses magnets to retain the battery which may attract metallic debris that could interfere with the connection of the battery to the drone.
  - Prior to installing the battery, inspect the battery connection pins and the battery bay to ensure that they are undamaged and free of debris.
  - Verify the battery is fully seated in the drone prior to launching.
- Do not fly with any batteries with enclosures that are cracked, swollen, gouged, dented, or otherwise substantially physically deformed.
- Safely handle and dispose of any batteries in accordance with all local laws and regulations.
- Batteries should not be stored in extreme environmental conditions.
- Ensure the Skydio X10 Controller has adequate battery life remaining to complete your intended flight.
- Ensure you have set your Return and Lost Connection behaviors before flying.
- Remove the sensor package lock before flying.
- Inspect the chassis and entire drone for damage and debris prior to flight.

## Environment

- Skydio X10 is IP55 rated providing protection from limited dust ingress and light to moderate precipitation conditions; it is recommended to not fly in heavy dust conditions or heavy precipitation.
- The Skydio X10 Controller is IP54 rated providing protection from limited dust ingress and light precipitation conditions; it is recommended to not be used in heavy dust conditions or moderate to heavy precipitation.
- Flight in icy conditions is not supported and may result in the loss of your drone.
- Flight in lightning is not supported and may result in the loss of your drone.
- Ensure the flight environment has good initial visibility and will have good visibility throughout the duration of the flight.
- Do not hand launch or hand land during windy days, when Low Light flight is enabled, when flying at night, or extreme environmental conditions as serious injury and/or damage may occur.
- Fly cautiously over bodies of water as low relative-altitude flight may degrade or impair autonomous flight performance. Before flying over bodies of water, ensure your drone has a strong GPS signal. Fly at least 10 ft (3 m) above the surface of the water.
  - Failure to acquire strong GPS prior to flight over water may result in erratic flight and/or emergency landing and total loss of the drone.
- Launch and land over dry surfaces. Use extreme caution and care when launching or landing from moving vessels.
- Skydio X10 requires good visibility to retain its obstacle avoidance capabilities. Obstacle avoidance can also be impaired when in low light (without NightSense) and poor visibility. Fly with extreme caution and care under these conditions.
- Skydio does not recommend flying the X10 under the following conditions which can result in serious injury and/or damage including total loss of the drone:
  - Wind speeds (including gusts) at or above 28 mph (45 km/h)
  - Temperatures less than -4°F (-20°C) or more than 113°F (45°C)
- The Skydio X10 battery features self-warming technology. When flying in temperatures below 32°F (0°C), prewarm batteries before launching. Battery endurance may be degraded when operating near temperature limits below -4°F (-20°C) and above 113°F (45°C).

## Flying Safely

- Your Skydio drone only avoids obstacles that are not in motion.
  - Cars, boats, people, animals, drones, crewed aircraft, or other moving objects may not be avoided.
- In the event that your X10 collides with an object, it will attempt to stabilize and continue flying.
- Keep your fingers away from the propellers anytime they are spinning such as during launch, flight, and landing.
- Skydio X10 can't see certain visually challenging obstacles. Do not fly around thin branches, telephone or power lines, ropes, netting, wires, chain link fencing, or other objects less than 0.5 inch (1.3 centimeters) in diameter. This type of crash is not covered under the Skydio Limited Warranty.
- Do not intentionally try to crash Skydio X10.
- The chassis of Skydio X10 may become hot to the touch in high-temperature environments or direct sunlight, even when powered off. The metal frame may also become hot if powered on while on the ground for long periods of time. Handle with extreme caution and care.
- Do not fly over bodies of water if Skydio X10 indicates a GPS quality warning.
- Exercise extreme caution and care when the sun is low on the horizon as it can temporarily blind the Skydio X10 cameras depending on the angle of flight. Your drone may be cautious or jerky when flying directly toward the sun.
- Skydio X10 may provide an indication, such as displaying an alert to land, if it encounters an issue or determines the environment is not safe for flying. Fly to the nearest safe area and land immediately.
- Flying at high altitudes may significantly increase the time required to return and safely land the Skydio X10. The pilot is solely responsible for managing altitude, range and battery level at all times.
- Be sure to read/watch all flight tutorials and safety-related materials and pay close attention to any in-app messages.
- Keep your hands on the controller joysticks to maintain control throughout flight.

## Flying Safely

---

- In preparation for landing, stop active autonomous Flight Skills and fly to a clear and stable area. Avoid areas with people, animals, and moving objects. Try to avoid areas with lots of fine pebbles, sand, rocks, or similar materials.
  - The lights on X10 will turn yellow as the drone descends below 10 ft (3 m) indicating that obstacle avoidance is disabled.
  - **WARNING:** Do not attempt to hand catch Skydio X10 before obstacle avoidance is disabled automatically during landing. Attempting to hand catch Skydio X10 while obstacle avoidance is still active will cause it to attempt to avoid your hand and may result in Skydio X10 impacting yourself or another nearby object, resulting in serious injury and/or damage.
  - While Skydio X10 is landing you may nudge the drone forward, backward, left, or right using the Skydio X10 Controller joysticks.
  - Always monitor Skydio X10 during landing and be prepared to use the “nudge” feature or cancel the landing if Skydio X10 is landing in an undesirable location. Use extreme caution and care when landing on elevated platforms, such as the roof of a car or truck, as the Skydio X10 may move laterally to avoid the platform before descending to the 10 ft (3 m) threshold.

## Regulations

- You are solely responsible for your Skydio X10 at all times.
- Always follow [FAA](#) and country-specific civil aviation authority regulations, as well as local, state, and federal laws and regulations when operating your Skydio X10.
- Download the [FAA Drone Safety Guide](#) (if located in the United States).
- Check resources including but not limited to [knowbeforeyoufly.org](#) for more information.
- Do not fly in an environment where the use of drones is restricted or not authorized.
- **Maintain visual line of sight at all times**, unless you have received express permission to fly beyond visual line of sight from a civil aviation authority such as the FAA.
- Skydio drones sold in the United States are Remote ID-compliant.



# How to Use this Manual

Review the Five Phases of Operations, key concepts, and Flight Crew Roles.

## This section covers

---

Overview

---

Using this Manual

---

Notice Regarding Printed Copies

---

Warnings and Advisories

---

Flight Crew Roles

---

Key Concepts

---

# Overview

The Skydio X10 Flight System has been specifically designed for operational use in commercial, industrial, and safety-critical applications. System readiness, operability, and reliability are achieved and maintained through the best practices that have been collated into this resource.

Depending on need, this manual can be leveraged at any time by navigating to a specific section. This manual is a living, controlled document and is regularly revised as flight system updates become available. This manual is uncontrolled when printed. Refer to the title page of this manual to find the most recent version and date of publication. The most recent version of this document can be accessed via Skydio Support.

Prior to engaging in any operational use of the flight system and throughout, it is recommended that safe use (delineated in Skydio's X10 Safety Guidelines) be practiced and reinforced.

# Using this Manual

This manual is organized into five primary Phases of Operation.

Prior to engaging in any operational use of the flight system and throughout, it is recommended that safe use (delineated in Skydio's Safety Guidelines) be practiced and reinforced.

Additional information regarding the objectives covered in each phase of operation can be found in the respective sections of this manual:

## **Initialization**

Performed prior to initial flight and with each addition or modification of a flight system component, initialization ensures that all components of the sUAS are functional for safe and effective flight. Updates, repairs, and replacements may be required to achieve or maintain operational readiness. Reconfiguring the flight system may be required for specialized operations.

## **Operations Planning**

Objectives of the flight operation are determined during operations planning. The date, time, location, duration, and desired outcomes of the flight operation (among other variables) will determine the flight system configuration, flight settings, crew members, and other resourcing needed for a successful flight. Use of **Waypoint Missions** on the X10 Controller and the **Missions** tab in Skydio Cloud (to pre-plan Map Captures) are recommended during this phase, when applicable.

## **Preflight**

The successful achievement of preflight objectives immediately prior to launch ensures that the sUAS is operationally ready, the environment is free from any observable hazards, and the PIC is ready for safe operation. A preflight inspection procedure includes a physical inspection of the flight system and reviewing cloud-based device health readings to clear the sUAS for operation.

## **Inflight Operations**

Launching, landing, and all drone activity while actively flying defines inflight operations. Objectives related to flight crew communications, situational awareness, and high-integrity data capture take precedence for safe and effective piloting.

## **Postflight**

Once the Skydio X10 has landed, postflight objectives include logging the flight, securing any reports or records, mission-related photogrammetry or evidentiary workflows, and preparing the system for future use.

# Notice Regarding Printed Copies

This manual is subject to updates. For the most current procedures, safety information, and operational guidance, refer to the online version of the manual on our [Support site](#). **Printed or locally stored copies may become outdated and should not be relied upon as the sole source of truth.**

It is the responsibility of the operator to ensure they are referencing the most recent version available online.

# Warnings and Advisories

Throughout this manual, warnings and advisories highlight important information and potential hazards related to operational use of the flight system.

Each safety-related Warning reflects a corresponding level of criticality:

### **Danger**

Indicates an immediate and unavoidable threat of death or serious injury.

Examples include: Exposed high-voltage equipment or unguarded machinery with moving parts.

### **Warning**

Indicates a potentially dangerous situation where death or serious injury could occur if precautions are not taken.

Examples include: falling objects or entering an active landing zone during an autonomous return.

### **Caution**

Indicates a potentially hazardous situation where minor or moderate injury could occur if precautions are not taken. Also used to highlight actions that could result in hardware damage, flight performance issues, or non-compliance with operational standards.

Examples include: Pinch and crush points, handling hot batteries, pointing a thermal camera at the sun.

### **Note**

Information advisories are indicated by Notes and may include information related to effective use of the flight system or special considerations. Notes provide additional context, clarification, or detail that supports understanding of a feature, setting, or behavior. Notes do not indicate risk or required action.

Examples include: Linking to related sections, reminders of unsupported configurations, or clarifying system behavior in specific conditions.

# Flight Crew Roles

This manual focuses primarily on the responsibilities of Organization Admins and Pilots in Command (PICs), who are typically the primary operators and system managers in a controller-flown operation workflow. All flight crew members, including Cloud Users, are responsible for reading this manual and understanding how the system functions to support safe, compliant, and effective operations.

## Role Responsibilities

### Organization Admin

Organization Admins manage system-level settings in Skydio Cloud. Admins are responsible for tasks such as maintaining fleet and equipment readiness, managing integrations, assigning user roles, and ensuring compliance with regulatory and organizational policy.

### Pilots in Command (PICs)

Pilots, or Pilots in Command (PICs) are individuals actively operating a Skydio X10 in the field using the X10 Controller. They are responsible for tasks such as piloting the sUAS, managing and flying missions (both manual or autonomous), capturing imagery or video, and responding to live conditions.

The PIC is solely responsible for the safe operation of the flight system during all phases of operation.

### Remote Pilots in Command (RPICs)

Remote Pilots, or Remote Pilots in Command (RPICs), conduct missions via Remote Flight Deck (RFD, the drone's remote Ground Control System), operating drones remotely rather than in person. This could include tasks such as piloting the sUAS, managing autonomous flights, monitoring live video feeds, and maintaining mission oversight from a command center or dispatch location.

If an RPIC commandeers control from a PIC, he or she is solely responsible for the safe operation of the flight system during all phases of operation.

### Cloud User

Cloud Users view and manage data in Skydio Cloud. This can include viewing and running flight reports, viewing, sharing, and deleting media, and viewing the device health pages. The Cloud User role is assigned to personnel who need access to data in the cloud but won't be flying remotely, such as a data analyst.

# Key Concepts

The following foundational concepts are mentioned throughout this manual:

### **Early Access Program (EAP)**

Early Access Programs provide select customers with the opportunity to try out upcoming features or products, which can help inform early development. These programs help customers prepare for new capabilities early on and allow Skydio to gather user feedback regarding feature utilization and implementation. Skydio representatives may be contacted to provide additional information.

### **Beta / Closed Beta**

Prior to making a product generally available, certain products may go through a Beta program. Features or products that are labeled Beta may have known limitations. Beta features may be new, experimental, or in active/late stage development.

Open Beta features are indicated by the 'Beta' tag; Closed Beta features require special authorization to access via Skydio's services teams. Skydio representatives may be contacted to provide additional information.

### **Flight System Updates: Software, Firmware, and Cloud Releases**

Skydio regularly releases updates across the entire flight system. These updates may deliver new features, improve performance, or resolve known issues. A single release may include a variety of updates across different parts of the system:

- **Software** updates apply to the physical components of the flight system (such as drones or attachments) that control how the drone operates (e.g., updated autonomous behavior). Organization Admins may use Skydio Cloud to update the software on their devices. Software updates for devices are initiated by the user.
- **Skydio Cloud** release updates will be delivered directly to the Skydio Cloud platform, which could include minor interface improvements or new features to the Cloud platform or Remote Flight Deck. Skydio Cloud release updates are delivered automatically.

Releases are accompanied by release notes on Skydio Support, which explain both new and improved features as well as known limitations and bug fixes. Release notes provide important details about how the updates will affect operations.

When a new release is published, customers will receive an email notification as well as in-Cloud alerts. It is everyone's responsibility to read the release notes and keep the flight system updated to ensure safe and effective operations.

## **Notices to Operators (NTOs)**

Skydio may issue a Notice to Operators (NTO) when we identify new safety or compliance risks, often as the result of newly-discovered software issues or unexpected edge cases. Read each NTO carefully to determine which parts of the flight system may be affected.

NTOs are designed to help RPICs avoid safety-critical issues that could affect flight safety and operations. The notice offers background information about the issue along with actionable, temporary mitigation guidance while long-term solutions are in progress.

Skydio updates NTOs whenever new information becomes available or a fix is released to ensure that RPICs are provided with timely information for mission planning.

NTOs are published on Skydio Support, and all Skydio Cloud users are notified via email and in-Cloud alerts when a new notice is issued or updated. It is the responsibility of the RPIC and the flight crew to review NTOs during mission planning and preflight operations to help maintain safe use of the flight system.

View the list of [current NTOs on our Support Site](#).



# Flight System Overview

*Relevant Flight Crew Role(s): All Flight Crew Roles*

The Flight System Overview details all components of the Skydio X10 Flight System. Each component is subject to continual updates over the lifespan of the flight system.

## This section covers

---

Skydio X10 Starter Kit

---

Skydio X10 Hardware

---

Skydio X10 Controller Hardware

---

Skydio Autonomy Features

---

Skydio Connect

---

Charging

---

Skydio Cloud Setup

---

# Skydio X10 Starter Kit

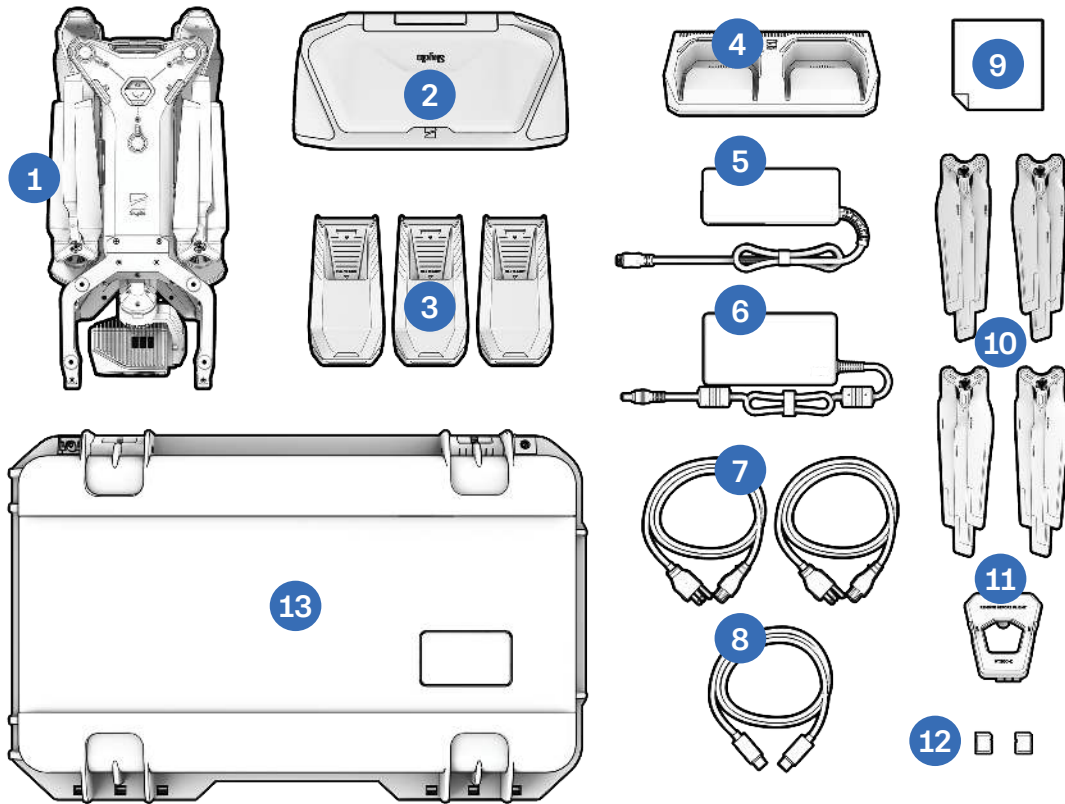

- 1. Skydio X10 and sensor package
- 2. Skydio X10 Controller with chosen Skydio Connect option
- 3. Batteries (3)
- 4. Skydio X10 Dual Charger
- 5. 100 W power supply (USB-C)
- 6. 230 W fast power supply (barrel jack)
- 7. Power cables (2)
- 8. USB-C to USB-C pairing cable
- 9. Microfiber cleaning cloth
- 10. Spare propeller sets (4)
- 11. Gimbal Stabilizer Clip
- 12. 256 GB microSD cards, pre-installed (2)
- 13. Starter Case (hard shell)

Also included in some international shipments: USB-C to A adapter cable, neck strap, LTE USB adapter, Ethernet adapter



Scan for more information about the kits available for purchase.

# Skydio X10 Starter Case Layout

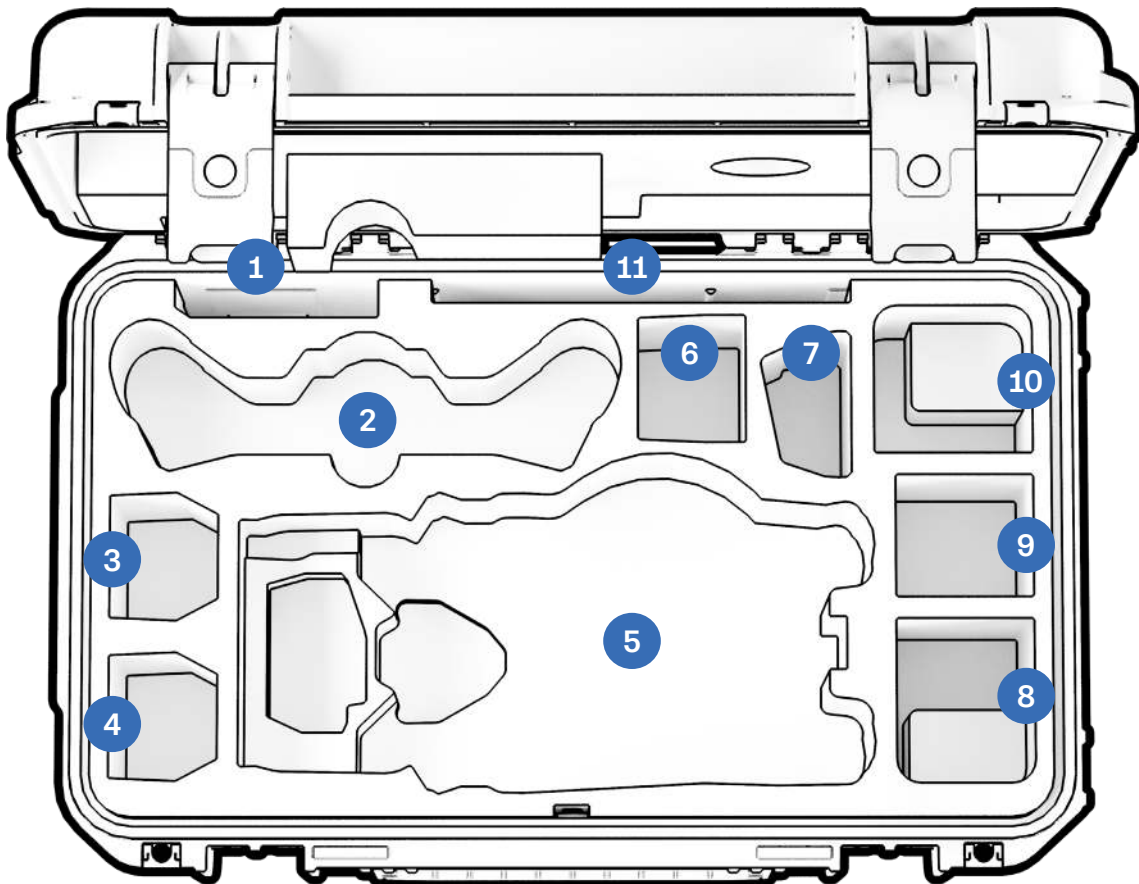

- |   |  |
|---|--|
| 1. Propellers                                   | 7. X10 Dual Charger  |
| 2. X10 Controller                               | 8. Flex space: 100W Power Supply or Attachment (battery not recommended) |
| 3. X10 Battery                                  | 9. Flex space: 100W Power Supply or Attachment (battery not recommended) |
| 4. X10 Battery                                  | 10. Flex Space: 230W Power Supply or Attachment                          |
| 5. Skydio X10 Drone                             | 11. Quick Start Guide and other documents                                |
| 6. Flex space: 100W Power Supply or X10 Battery |  |



**NOTE:** If you purchased a Starter Case prior to March 2026 and later upgrade to the VT300-Z REV2 sensor package, the REV2 will not fit in your existing case. Skydio X10 Starter Cases purchased after March 2026 are compatible with the VT300-Z REV2.

# Skydio X10 Hardware

1. Chassis
2. Arm (4)
3. Sensor package
4. Sensor package frame
5. Log and Media card slots (2)
6. Top navigation cameras (3)
7. Top attachment bay (A2)
8. Side attachment bay (A3, A4)
9. Bottom navigation cameras (3)
10. Bottom attachment bay (A1)
11. Time of flight sensor

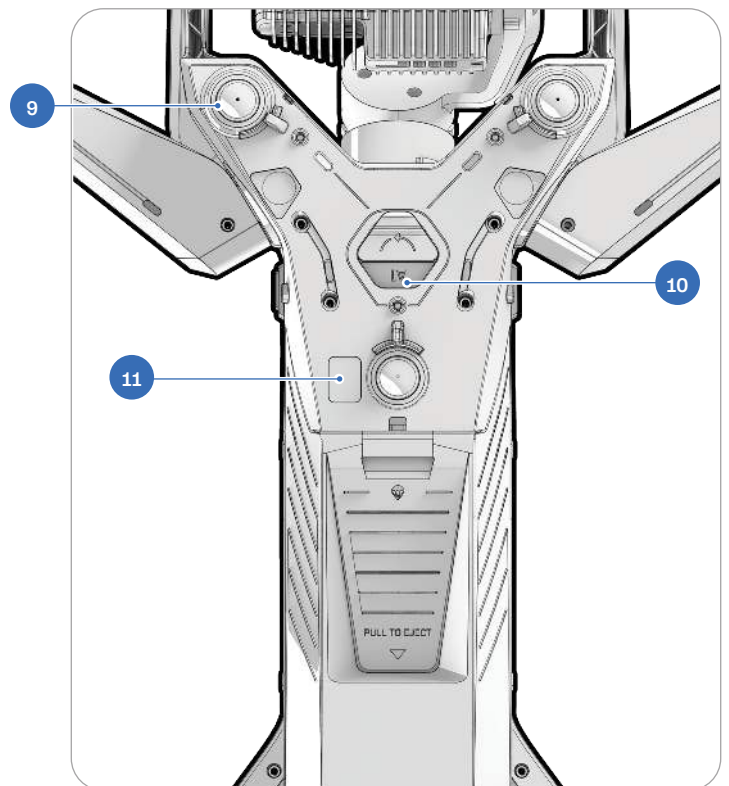
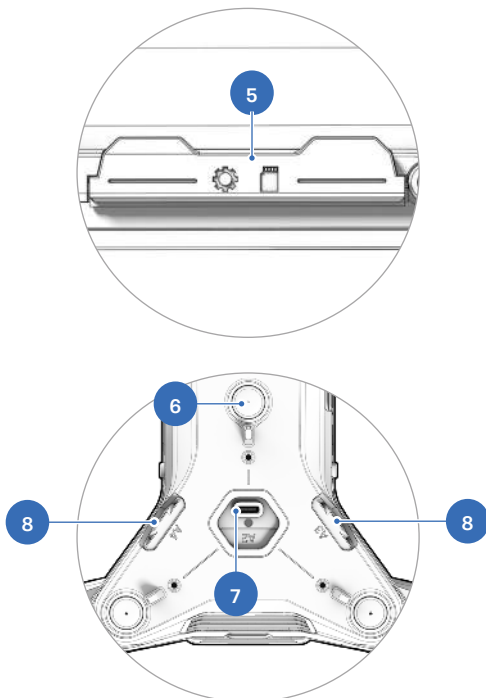
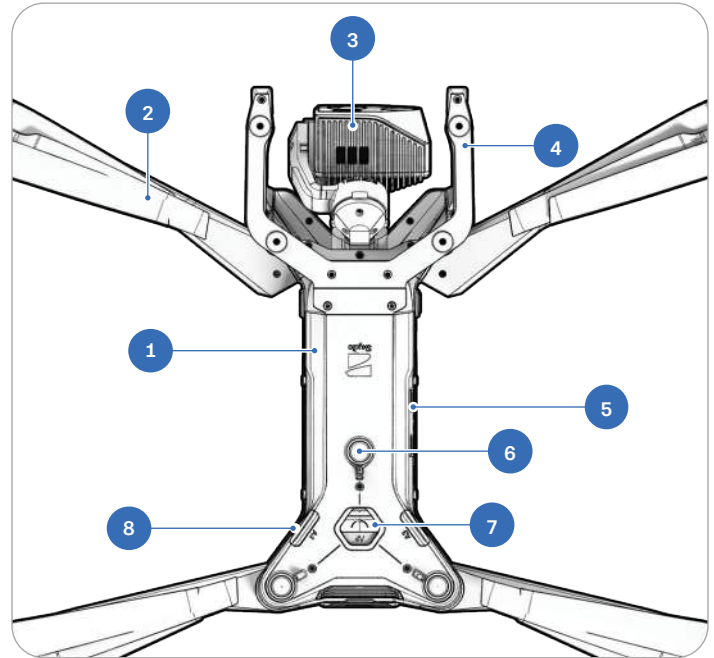

## Flight System Overview

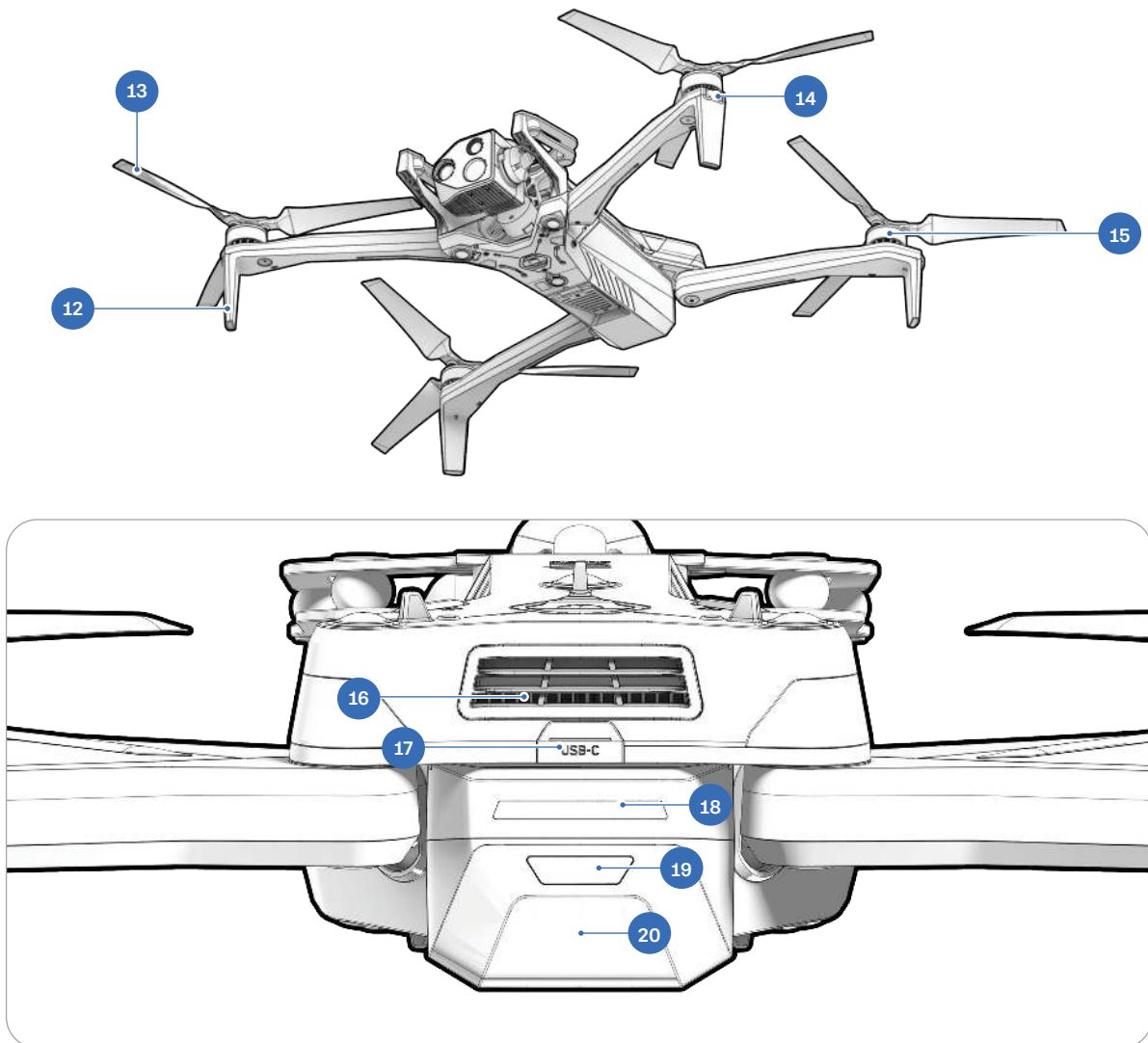

**12.** Landing feet/antennas

**13.** Propeller blades

**14.** RGB/strobe lights

**15.** Propeller motors

**16.** Cooling fan/outlet

**17.** USB-C charge port

**18.** Battery lights

**19.** Power button

**20.** Battery



*Scan for more information about the sensor packages available for purchase.*

# Skydio X10 Controller Hardware

1. Left joystick
2. Menu/Back button
3. C1 button<sup>1</sup>
4. C2 button<sup>1</sup>
5. C3 button<sup>1</sup>
6. Power button
7. Launch/Return/Land button
8. Pause button
9. Directional pad (D-pad)
10. Right joystick
11. Controller cover/antennas
12. R1 button (Shutter)
13. Right wheel
14. HDMI port
15. USB-C charge port
16. L1 button (Boost)
17. Left wheel<sup>1</sup>
18. R2 button<sup>1</sup>
19. Cooling fan
20. Neck strap<sup>2</sup> and tripod mount
21. L2 button<sup>1</sup>

<sup>1</sup>Customizable

<sup>2</sup>Neck strap sold separately

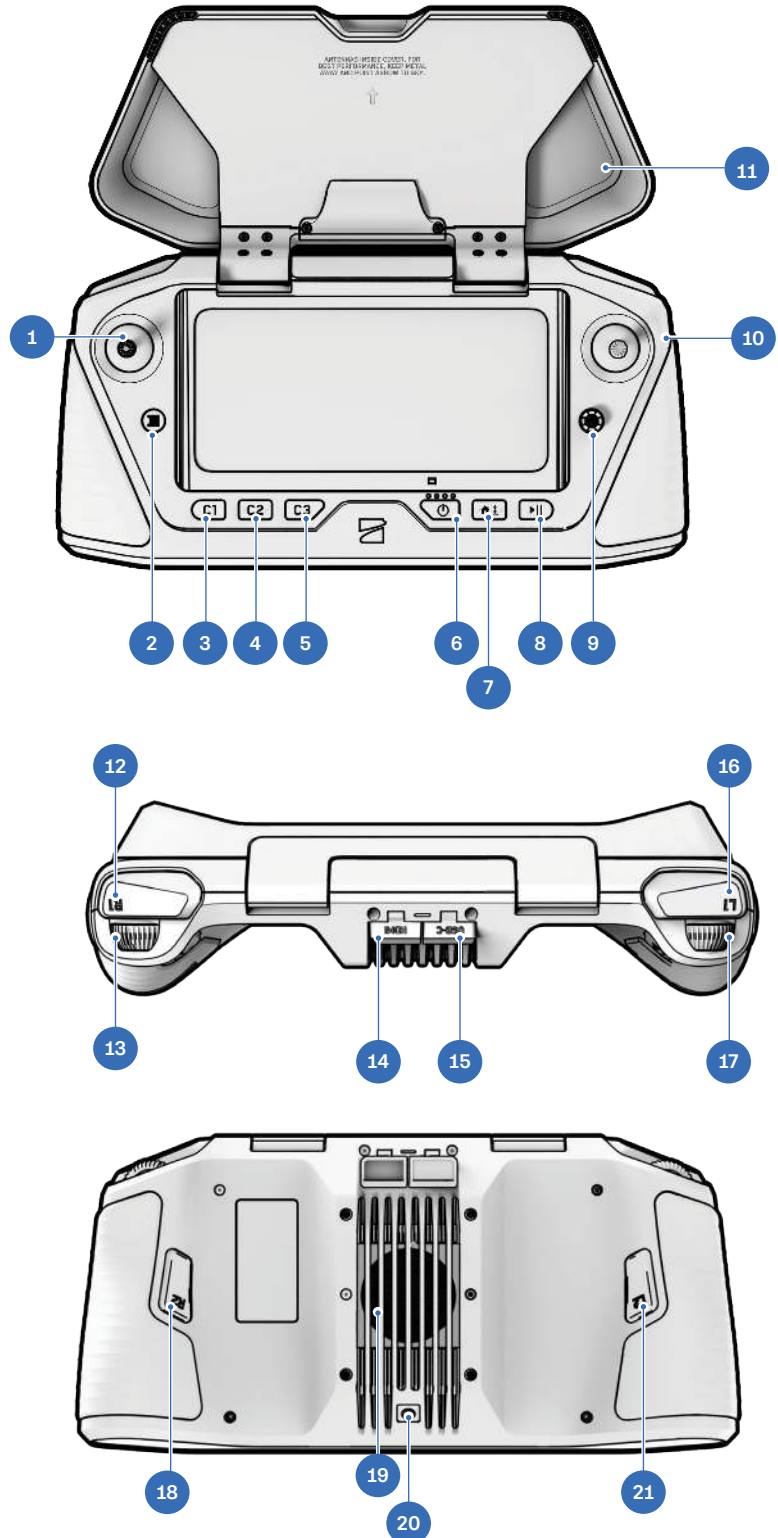

# Skydio X10 Overview and Autonomy

## Airframe and Mechanical Design

Skydio X10 is a foldable, quadrotor unmanned aircraft system (UAS) designed for portable, single-operator deployment.

- Weight (incl. battery): ~4.65–4.75 lb (2.11–2.16 kg), configuration-dependent
- Folded Dimensions: 13.8 in (35 cm) length (folded configuration)
- Ingress Protection Rating: IP55

See the *Specifications* section for more details.

The foldable arm architecture enables rapid transition from stowed to flight-ready configuration. Typical deployment time from folded state to motor start is under 40 seconds, depending on configuration.

The propulsion system is optimized for high-thrust efficiency enabling:

- Maximum forward flight speed: 45 mph (20 m/s)
- Stable flight under varying payload and environmental conditions

Power and thermal management systems dynamically adjust thrust and performance limits to maintain safe operating envelopes during high-speed transit or elevated ambient temperatures.

## Navigation and Perception System

Skydio X10 incorporates a distributed visual navigation architecture consisting of six custom navigation cameras positioned to provide 360° environmental awareness.

The navigation system integrates:

- Six visual navigation cameras
- Inertial Measurement Unit (IMU)
- Global Navigation Satellite System (GNSS) receiver
- Magnetometer

## Flight System Overview

---

Onboard navigation systems combine visual, inertial, and GNSS data to provide:

- Visual-Inertial Odometry (VIO)
- GPS-assisted global positioning
- Stable orientation and heading estimation

The omnidirectional camera placement eliminates blind spots and supports obstacle avoidance and autonomous flight in complex environments.

The system is designed to maintain controlled flight in:

- GPS-degraded or GPS-denied conditions
- Low-texture environments
- High electromagnetic interference (EMI) environments

## Onboard Compute Architecture

Skydio X10 is powered by an embedded NVIDIA Jetson Orin GPU platform, providing high-throughput onboard processing for real-time autonomy and perception tasks.

The compute subsystem supports:

- Obstacle detection and avoidance
- AI-based subject tracking and following
- Autonomous mission execution
- 3D scene reconstruction and mapping

All autonomy, navigation, and perception functions are executed onboard the drone.

## Thermal Imaging System

Skydio X10 integrates the Teledyne FLIR Boson+ thermal imaging core. The Boson+ sensor provides radiometric thermal measurement capability, supporting:

- Absolute temperature measurement
- Low-contrast thermal differentiation
- Enhanced detection performance in low-visibility conditions

Thermal data is processed onboard and available for real-time visualization and mission execution.

### Sensor Packages

**Sensor packages** are a combination of cameras and sensors mounted on the front of the drone, stabilized by a gimbal. These packages may feature thermal imaging or integrated flashlights to support various operational needs. Sensor packages are designed to capture precise data across various environments and applications.

The modular X10 sensor package options combine:

- High-resolution visual camera(s)
- Radiometric thermal imaging sensor

The stabilized gimbal assembly provides controlled pitch movement and maintains image stability during flight maneuvers.

Optical design emphasizes:

- High pixel density
- Edge clarity
- Inspection-grade imaging performance

### Attachments

**Attachments** are [optional accessories](#) that can be added to enhance the functionality of the drone, such as advanced lighting or communication tools. These add-ons allow you to customize X10 for unique mission requirements.

Skydio X10 features four external attachment ports for mission-specific modules. Attachment ports provide integrated power and data interfaces.

- Maximum external payload: 12 oz (340 g)

### Supported Configurations for Multiple Attachments

#### Two attachments

- Parachute + NightSense
- Parachute + Spotlight
- Parachute + Speaker
- Parachute + Fusion+
- Parachute + RTK/PPK
- NightSense + Spotlight
- NightSense + Speaker
- NightSense + Fusion+
- Spotlight + Speaker
- Spotlight + Fusion+
- Speaker + Fusion+

#### Three attachments

- NightSense + Spotlight + Speaker
- Parachute + NightSense + Spotlight
- Parachute + NightSense + Speaker
- Parachute + NightSense + Fusion+



**NOTE:** *NightSense refers to both top and bottom attachments.*

## Software

Skydio X10 comes equipped with the following software features:

- 360° Obstacle Avoidance
- Low Light Flight
- Manual Flight
- Map Capture
- Motion Planning
- Object/Scene Recognition
- Offline Maps/Map Importing
- Point of Interest Orbit
- Real-time 3D mapping
- Skydio Visual Navigator
- Subject Detection
- Thermal Tools
- Track in Place (subject tracking)
- Visual Return-to-Home
- Waypoint Missions
- Zoom

In addition to these built-in capabilities, Skydio offers additional software applications—such as Remote Flight Deck for collaborative flight operations and 3D Scan for high-resolution, automated scanning—to further expand the functionality of Skydio X10.

## Solution Bundles for Specific Use Cases

Skydio also offers pre-configured solution bundles tailored to specific applications. These bundles provide the ideal combination of hardware, software, and accessories for tasks like Drone as First Responder (DFR), bridge inspection, and utility management, ensuring you have the tools you need right out of the box.

### Skydio Connect

Skydio Connect includes various radio connectivity options between Skydio X10, the Skydio X10 Controller, and Flight Deck controls, whether you're flying with the controller or via browser.

There are two Skydio Connect options when purchasing your Skydio X10:

**Skydio Connect SL** provides a proprietary, optimized point-to-point wireless link between X10 and the controller. With line-of-sight distances up to 7.5 miles or 12 kilometers, SL offers robust performance for most autonomous flight missions.

- Operating frequency: 2.4 GHz, 5GHz
- Range in ideal conditions: 7.5 mi (12 km)

**Skydio Connect 5G** allows you to fly Skydio X10 anywhere with a stable cellular connection. With the addition of Skydio Remote Flight Deck you can also operate your Skydio drones through an internet browser via Skydio Cloud. You will also be able to remotely operate your drones from any Skydio X10 Controller that is connected to your 5G network.



**NOTE:** *When flying with Skydio Connect SL, always maintain a clear line of sight between the controller and drone.*

# Skydio Connect Fusion

If you purchased Skydio Connect 5G, you will have access to Connect SL along with **Skydio Fusion**.

**Skydio Connect Fusion** provides continuous, high-quality video by encoding separate streams for both Connect SL and Connect 5G, then dynamically selects the strongest feed in real-time.

Pilots do not need to manually manage radio links as Skydio X10 and the X10 Controller will optimize inflight connectivity by automatically switching between Connect 5G (cellular) and Connect SL (point-to-point), ensuring the best available connection is always in use.

- Fusion is set as the default **Flight Connection** within the **Radio** menu
- Select **FUS** in the telemetry bar to view detailed connection health status

The **Skydio Connect Fusion+ Attachment** accompanies the Fusion+ service subscription. The Fusion+ hardware consists of a side-mounted cellular attachment for X10 and X10 Gen 2 that adds an additional active cellular signal. It is required to enable Fusion+ multi-radio connectivity.



**NOTE:** The Fusion+ Attachment is supported on Skydio X10 Gen 1 and Gen 2 Flight Systems with or without Skydio Connect 5G. Skydio X10D Flight Systems are not supported.



# Charging Skydio X10 Batteries

Skydio X10 batteries are shipped in a state of hibernation and will not power on your drone out of the box. Your batteries will automatically exit this state once they begin charging for the first time.

## Using the Skydio X10 Dual Charger

The Skydio X10 Dual Charger sequentially charges two batteries. The Dual Charger will prioritize fully charging the battery with the highest charge level. If both batteries are depleted, it will prioritize the battery that is inserted first.

### Step 1 - Remove battery from drone

Skydio X10 batteries are held in place using a magnetic connection.

1. Firmly grip the drone chassis with one hand
2. Grip the battery with your other hand, placing your palm over the power button and wrapping your thumb under the battery
3. Using your fingers as leverage, press against the drone until the magnets disengage and slide the battery away from the sensor package



# Flight System Overview

---

## Step 2 - Place batteries into the X10 Dual Charger

Ensure the battery and connection pins are free of debris and interference. Gently push down to ensure the batteries are properly seated.

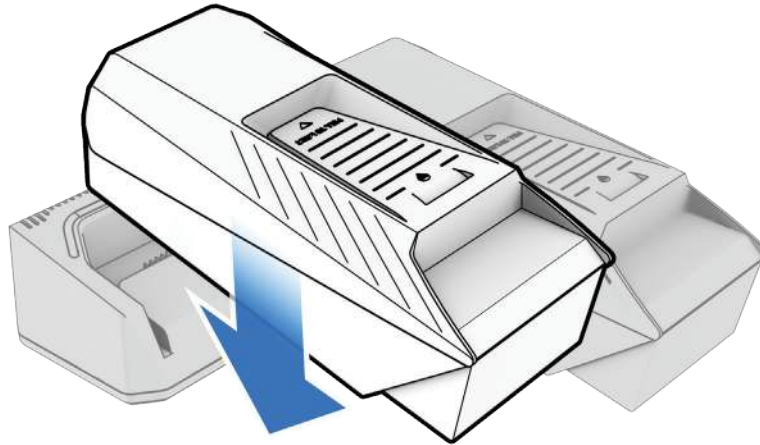

## Step 3 - Insert the power supply

Two charging ports are located on the back of the Skydio X10 Dual Charger. You may use either the 100 W USB-C power supply or the 230 W fast power supply.

Plug into a power source.

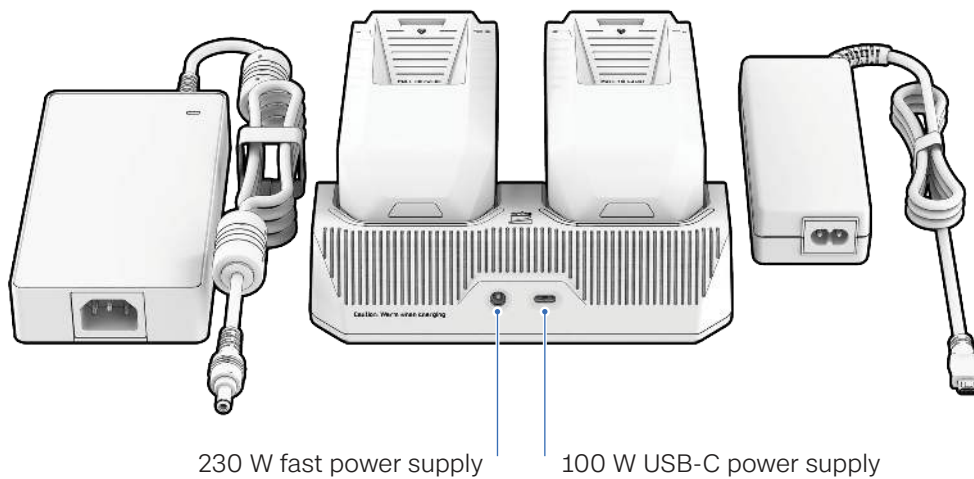

# Flight System Overview



**CAUTION:** *Third-party adapters and cables are not supported. Only use the Skydio-provided power supplies and cables to charge your batteries.*



**NOTE:** *Pass-through charging is not currently supported. This functionality will be enabled in a future software update.*

## Battery Charge State

## Light Behavior on X10 Dual Charger

Actively charging

Pulsing blue

Waiting to charge

Solid blue

Charging complete

Solid green

## Power Supply

## Input

## Charge Time

230 W

20VDC, 11.5A

About 1 hour to charge a depleted battery

100 W

5-20VDC, 3A / 20VDC, 5A

About 1 hour 45 minutes to charge a depleted battery

# Using Skydio X10

### Step 1 - Insert battery

Align the battery with the rails and slide toward the sensor package until the magnets engage.

- Ensure the battery and rails are free of debris and interference
- Ensure the battery is completely seated before flying



### Step 2 - Locate the charging USB-C port

The charging port is located on the back of the drone above the battery. This is the only USB-C port that supports charging.

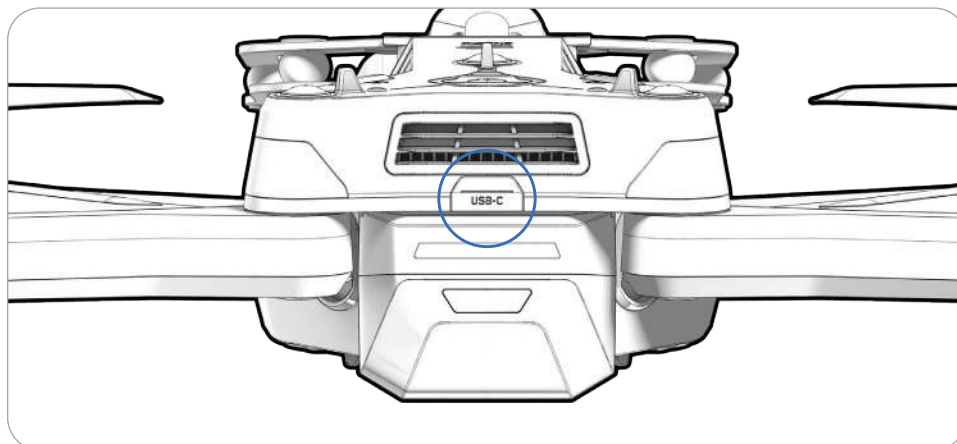

## Flight System Overview

---

### Step 3 - Insert the 100 W power supply

Plug into a power source.

- It will take about 2 hours to fully charge a depleted battery using the 100 W power supply

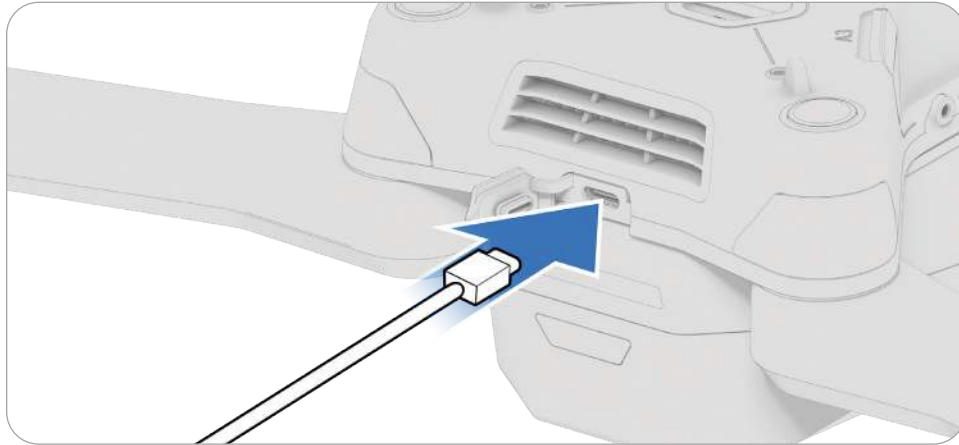

# Charging the Skydio X10 Controller

## Step 1 - Locate the USB-C port

The charging port is located on the back of the controller.

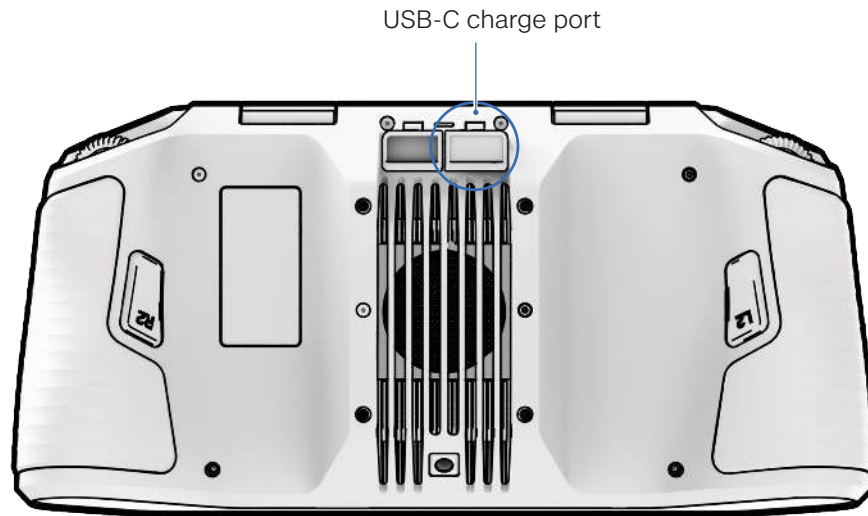

## Step 2 - Insert the 100 W power supply

Connect your Skydio X10 Controller to the 100 W power supply. Plug into a power source. The lights on the front of the controller will turn on and indicate the level of charge.

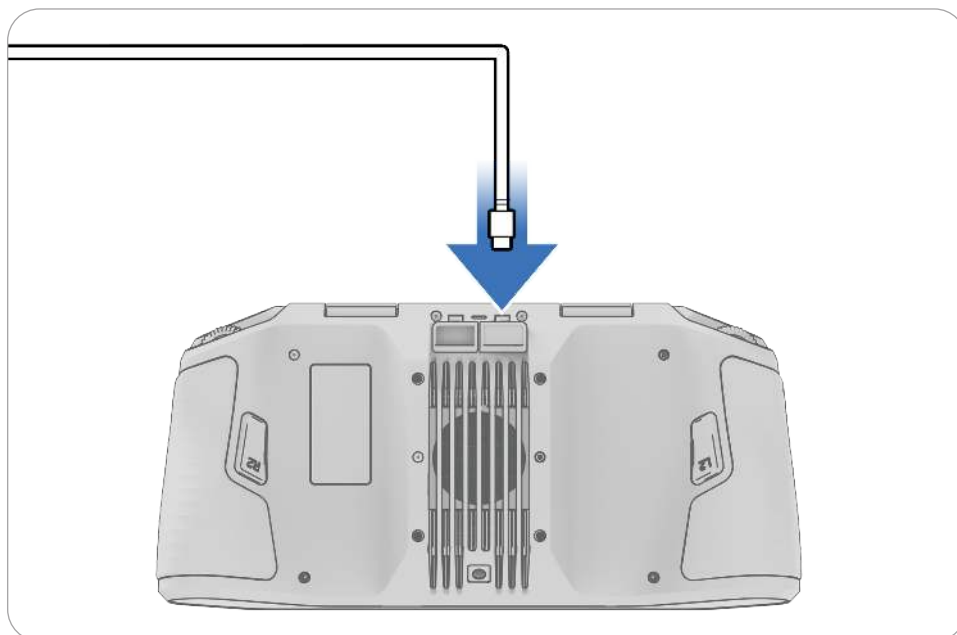

# Specifications

## X10 Drone

---

<b>Applicable Model Numbers</b>	SR47PI, SR47PV, SR47PCI, SR47PCV SR47PC9V
<b>Dimensions (unfolded, with propellers)</b>	31.1" x 25.6" x 5.7"
<b>Dimensions (folded, without battery)</b>	13.8" x 6.5" x 4.7"
<b>Weight (incl. batteries)</b>	Connect SL: 2.11 kg / 4.65 lbs Connect SL + 5G1: 2.14 kg / 4.72 lbs
<b>Max Launch Weight</b>	2.49 kg / 5.49 lbs
<b>Operation Frequency</b>	Connect SL: 2400-2483.5MHz, 5150-5850Mhz
<b>Transmitter Power (EIRP)</b>	Connect SL: 34.3dBmi (2.4GHZ) Connect SL: 33.7dBmi (5GHZ)
<b>Hovering Accuracy (windless or breezy)</b>	VIO: +/- 10cm
<b>Max Angular Velocity</b>	GNSS: +/- 1m
<b>Max Tilt Angle</b>	Yaw: 100 deg/s Roll / Pitch: 225 deg/s 40 degrees
<b>Max Ascent/Descent Speed</b>	Ascent: 6 m/s / 13.4mph Descent: 4 m/s / 9.0mph
<b>Max Non-Vertical Descent Speed</b>	6 m/s / 13.4mph
<b>Max Horizontal Speed (at sea level)</b>	20 m/s / 45mph
<b>Max Horizontal Speed with Obstacle Avoidance</b>	16 m/s / 36mph
<b>Max Service Ceiling Above Sea Level (without other payload)</b>	15,000 ft density altitude
<b>Max Gust Handling</b>	Under 12.8 m/s / 28 mph
<b>Max Hover Time</b>	35 minutes
<b>Max Flight Time<sup>1</sup></b>	40 minutes

# Flight System Overview

---

<b>Processors</b>	NVIDIA Jetson Orin SoC Qualcomm QRB5165 SoC
<b>Ingress Protection Rating</b>	IP55
<b>GNSS</b>	GPS + Galileo + GLONASS + BeiDou
<b>Operational Temperature Range</b>	-20C to +45C / -4F to 113F
<b>Wireless Range (no interference, line of sight operation)</b>	Connect SL: 12km / 7.5 miles
<b>Wireless Networking (media offload)</b>	Connect SL: WiFi6
<b>Obstacle Avoidance Coverage</b>	True 360°

<sup>1</sup>In optimal, controlled conditions; completely depleting a fully charged battery

## X10 Controller

---

<b>Controller Dimensions</b>	10" x 5" x 3"
<b>Dimensions</b>	10.5" x 5" x 3"
<b>Screen</b>	6.6" Dynamic AMOLED touchscreen 120Hz Adaptive Refresh Rate Resolution: 2340 x 1080 pixels Brightness: 1750 nits (outdoor peak) 392ppi
<b>Weight</b>	1135 grams
<b>Max Range</b>	Connect SL: 12km / 7.5 miles
<b>Operating Frequencies</b>	Connect SL: 2400-2483.5MHz, 5150-5850MHz
<b>Transmitter Power (EIRP)</b>	Connect SL: 34.7dBmi (2.4GHz) Connect SL: 35.9dBmi (5GHz)
<b>Ingress Protection Rating</b>	IP54
<b>Operating Time</b>	Approx. 5 hours
<b>Battery</b>	9600mAH
<b>GNSS</b>	GPS + Galileo + GLONASS + BeiDou
<b>Operational Temperature Range</b>	-20C to +45C / -4F to 113F
<b>Wired Outputs</b>	HDMI & USB-C
<b>Wireless Networking</b>	WiFi, Cellular LTE/5G 1
<b>Security</b>	NDA compliant AES-256 encrypted data link Encrypted internal disk storage Password protected Root of trust Trusted boot Secure update

---

### VT300-Z Sensor Package

---

Angular Vibration Range	+/-0.01°
User Controllable Range	+/-90° pitch
Mechanical Range	+/-140° pitch, +/-90° yaw, +75° to -230° roll

---

### VT300-L and V100-L Sensor Package

---

Angular Vibration Range	+/-0.01°
User Controllable Range	+/-90° pitch
Mechanical Range	+/-140° pitch, +/-90° yaw, +75° to -230° roll
Flashlight Illumination	22 lux at 3 meters

---

### Telephoto Camera (VT300-Z only)

---

Sensor	1/2" 48MP CMOS
Diagonal Field of View	13°
Focal Length	35 mm (190 mm equivalent)
Aperture	f/2.2
Focus	hybrid PDAF, 5 m to ∞
Exposure Compensation	+/-3
Electronic Shutter Speed	1/30 to 1/8000
ISO Range	100 to 16000
Max Video Resolution	3840 x 2880
Max Photo Size	8000 x 6000

### Wide Camera (VT300-L and V100-L only)

---

Sensor	1" 50.3MP CMOS
Diagonal Field of View	93°
Focal Length	8 mm (20 mm equivalent)
Aperture	f/1.95
Focus	100% focus pixel, 1 m to ∞
Exposure Compensation	+/-3
Electronic Shutter Speed	1/30 to 1/8000
ISO Range	100 to 16000
Max Video Resolution	3840 x 2880
Max Photo Size	8192 x 6144

### Narrow Camera (VT300-Z, VT300-L, and V100-L)

---

<b>Sensor</b>	1/1.7" 64MP CMOS
<b>Diagonal Field of View</b>	50°
<b>Focal Length</b>	10 mm (46 mm equivalent)
<b>Aperture</b>	f/1.8
<b>Focus</b>	hybrid PDAF, 1 m to ∞
<b>Exposure Compensation</b>	+/-3
<b>Electronic Shutter Speed</b>	1/30 to 1/8000
<b>ISO Range</b>	100 to 16000
<b>Max Video Resolution</b>	3840 x 2880
<b>Max Photo Size</b>	9248 x 6944

---

### Thermal Camera (VT300-Z and VT300-L)

---

<b>Thermal Imager</b>	Flir Boson+ Uncooled VOx Microbolometer
<b>Diagonal Field of View</b>	41°
<b>Focal Length</b>	13.6 mm (60 mm equivalent)
<b>Aperture</b>	f/1.0
<b>Focus</b>	5 m to ∞
<b>Thermal Sensitivity</b>	<30mK NEDT
<b>Infrared Temperature Measurement Accuracy</b>	Larger of +- 5°C or 5%
<b>Image Processing</b>	Adreno 650 GPU accelerated ISP pipeline
<b>Max Video Resolution</b>	640 x 512
<b>Photo Size</b>	640 x 512
<b>Photo Format</b>	JPEG, RJPEG
<b>Pixel Pitch</b>	12 um
<b>Temperature Measurement Method</b>	Spot Meter, Region of Interest
<b>Temperature Measurement Range</b>	-40° to 150° C (-40° to 350° C low gain)
<b>Palette</b>	White hot Black hot Ironbow Rainbow

---

### Vision Systems / Navigation Cameras

---

<b>Configuration</b>	6x cameras in trinocular configuration top and bottom
<b>Sensor</b>	1/2.8" 32MP color CMOS
<b>Light Sensitivity</b>	Visible Light
<b>Aperture</b>	f/1.8
<b>Diagonal Field of View</b>	200°
<b>Obstacle Sensing Range</b>	20 meters
<b>Environment Coverage</b>	True 360°

---

### Flight Battery

---

<b>Capacity</b>	8419 mAh
<b>Voltage</b>	18.55 V
<b>Battery Type</b>	Rechargeable Lithium Ion Polymer
<b>Energy</b>	156.17 Wh
<b>Net Weight</b>	1.56 lbs +/- 0.003 lbs
<b>Operational Temperature Range</b>	-20C to 60C
<b>Storage Temperature Range</b>	-20C to +45C (storage less than 3 months)
<b>Charging Temperature Range</b>	5C to 45C
<b>Chemical System</b>	Lithium Ion Polymer

---

### Skydio Connect

---

<b>Operating Frequency</b>	Connect SL: 2400-2483.5MHz, 5150-5850MHz
<b>Transmitter Power (EIRP)</b>	Connect SL: 34.7dBmi (2.4GHz) Connect SL: 35.9dBmi (5GHZ)
<b>Antenna Configuration</b>	Connect SL: 2Tx, 4Rx

---

### System Security

---

<b>Wireless Encryption</b>	Connect SL: AES-256
<b>NDAA Compliance</b>	NDAA Compliant
<b>Root of Trust</b>	HSM protected keys
<b>System Integrity</b>	Secure boot
<b>Secure Update</b>	AES-256 encrypted, signed, & verified
<b>Internal Disk Storage</b>	Encrypted
<b>SD Cards</b>	Unencrypted
<b>Pairing</b>	Secure wired pairing

---

### X10 Dual Charger and Power Supplies

---

<b>Dimensions</b>	180 x 75 x 48mm
<b>Weight (w/o Battery)</b>	0.73 lbs
<b>Charge Time 230W</b>	1 hour (0-100%)
<b>Charge Time 100W</b>	1 hour 45 minutes (0-100%)
<b>Weatherproofing</b>	No ingress protection
<b>Power input (100W USB-C)</b>	5VDC, 3A / 20VDC, 5A (USB PD)
<b>Power input (230W DC Barrel)</b>	20VDC, 11.5A

---



# Flight System Initialization

*Relevant Flight Crew Role(s): Organization Admins, Pilot in Command (PIC)*

*Flight system initialization ensures all components are properly configured and functional for safe and effective flight.*

## **This section covers**

---

Skydio Cloud Setup

---

Skydio X10 Setup

---

Skydio X10 Controller Setup

---

Updating Skydio X10 and X10 Controller

---

Skydio Connect 5G Setup

---

Battery warming in Cold Environments

---

Remote ID

---

ADS-B Alerts

---

# Overview

Flight system initialization ensures that all components of the Skydio X10 Flight System are properly configured and functional for safe and effective flight.

Initialization includes all activities that prepare the sUAS for a pre-planned mission, or live flight within a pre-determined geographic area. This includes powering on the flight system, performing system diagnostics, conducting any relevant repairs or maintenance, preparing mission-specific information and mapping waypoints, and ensuring all components are ready for operation.

# Skydio Cloud Setup

Before flying, an Organization Admin will need to configure your Skydio Cloud account in order to manage your fleet or sync your media. This includes configuring your organization settings, adding users, claiming your Skydio X10, and connecting to wireless networks.



**NOTE:** Skydio X10 and the X10 Controller must be claimed in Skydio Cloud to receive software updates and fly with Connect 5G.

As part of our onboarding process, Skydio will create the initial admin user for your organization. An admin level is required to set up your Skydio Cloud organization.



**INFO:** For more information about setting up Skydio Cloud, visit [Getting Started with Skydio Cloud](#).

## Log in and configure settings

### Step 1 - Log in

Visit [cloud.skydio.com](https://cloud.skydio.com) and enter your email address. Enter the verification code sent to your email address.

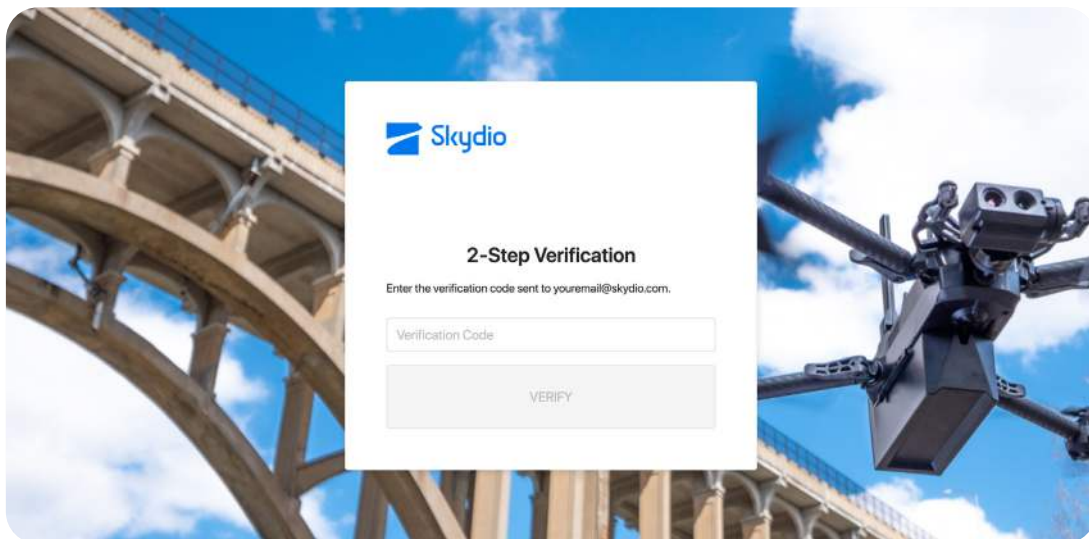

# Flight System Initialization

## Step 2 - Select Settings > General

Upload a logo for your organization to replace the Skydio logo in the upper left corner (optional).

Enable Data Capture which allows GPS and telemetry data to automatically upload to the cloud after each flight.

If Data Capture is toggled off, the flight path and other telemetry data will not display on the flight screen.

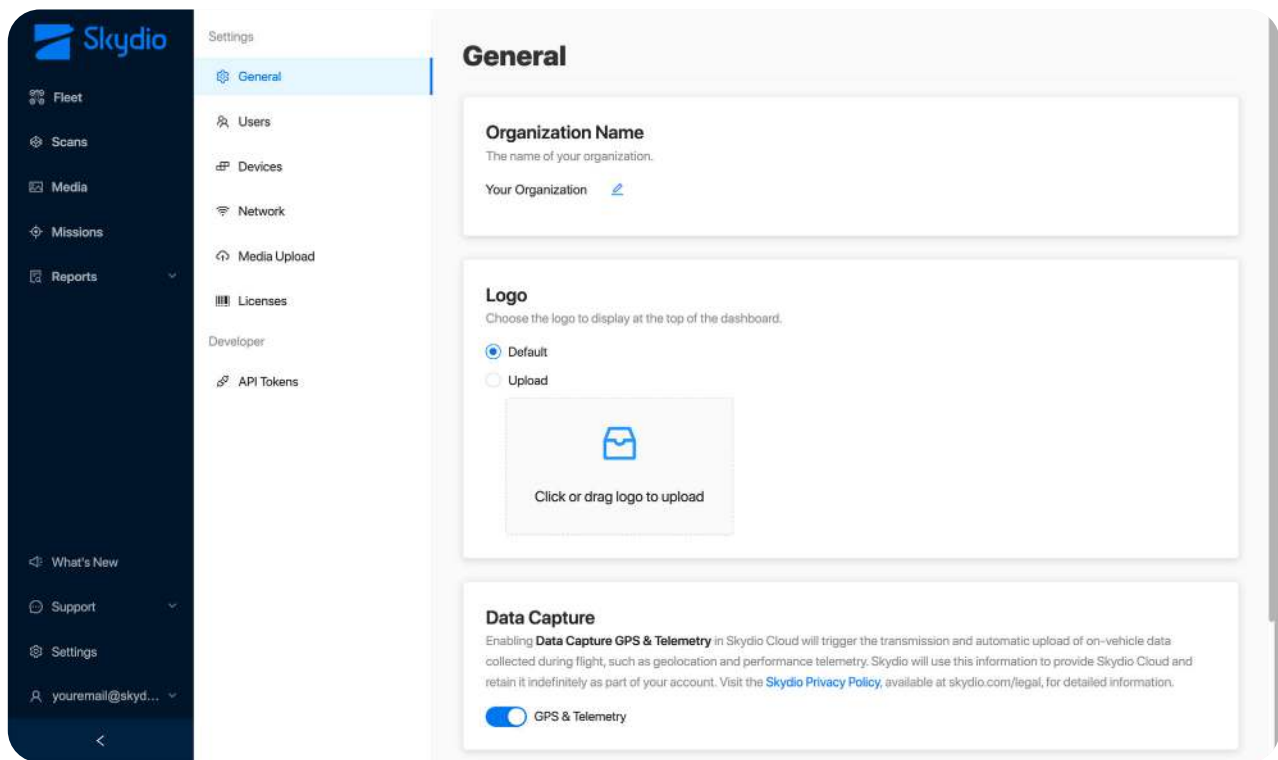

## Add Users

### Step 1 - Select Settings

### Step 2 - Select Users

### Step 3 - Add members

Select **Add User**. Add an email address for the user and assign a role.

This is a crucial step to ensure pilots in your organization can access Skydio Flight Deck on their X10 controller.

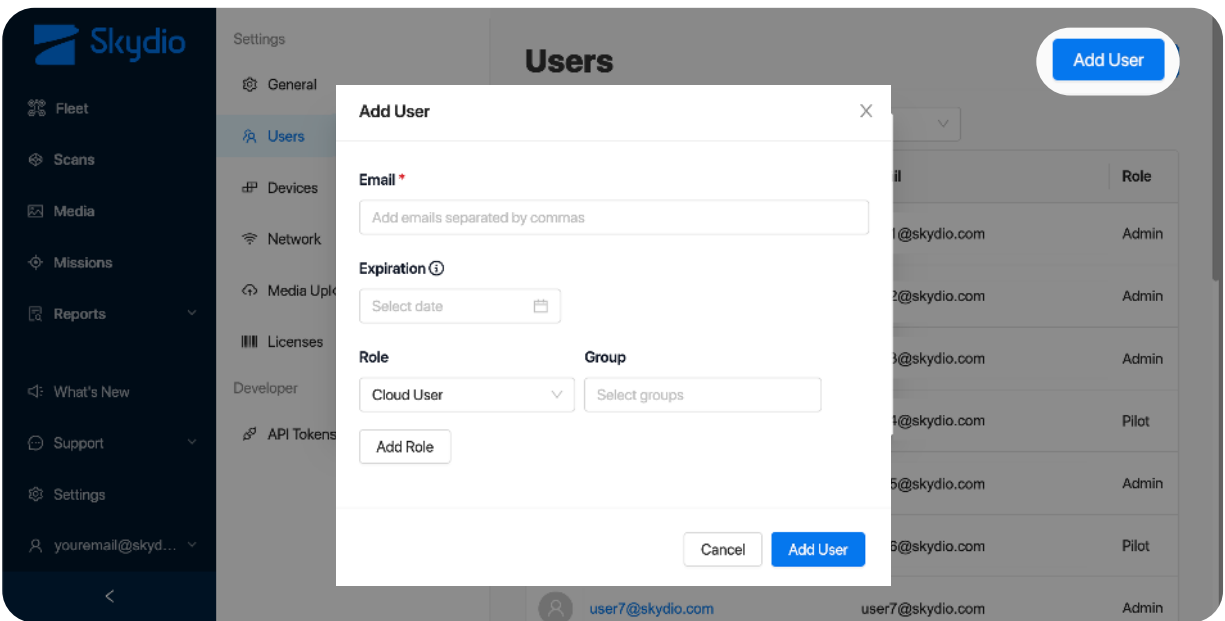

**NOTE:** Only Admin level accounts can add users. A member email address can only be associated with one organization at a time. Use the **Login Methods** tab to configure settings such as [Single Sign-On \(SSO\)](#).

## Claim Devices

You will need to **claim your drone and controller in Skydio Cloud to receive software updates**. Claiming your drone, controller, attachments, and batteries also enables you to track usage metrics and assign additional software licenses. Skydio X10 is not automatically associated with an organization, meaning you will need to claim the devices that you want in your fleet.

### Step 1 - Select Settings

### Step 2 - Select Devices

### Step 3 - Select Claim Device

**Step 4 - Depending on the device you are claiming, enter either the UAV name, serial number, or battery serial number**

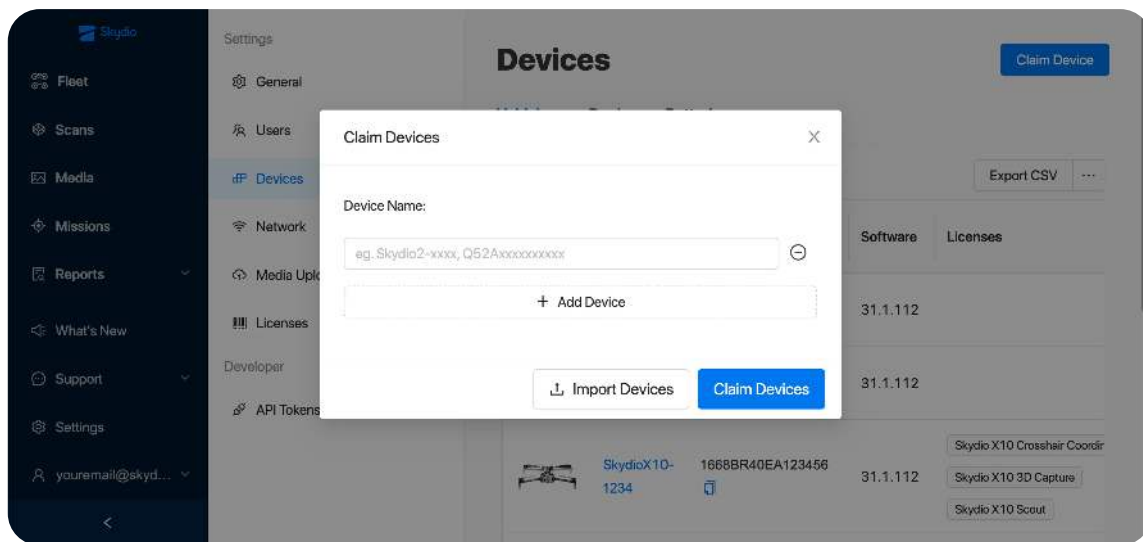



**NOTE:** For organizations with large fleets, your Customer Success Manager can assist in bulk claiming your new Skydio drones and batteries in Skydio Cloud.

## Finding Drone Name, Controller Serial Number, and Battery Serial Number

### Skydio X10 UAV Name

This begins with **SkydioX10-** and can be found on the label inside the battery bay of the drone.

**UAV Name:** SkydioX10-#### **Serial Number:** 1668B12345678901

 (S) SER 1688B12345678901  Assembled in the USA

(17V) MFR 86PV4

(1P) PNO 920-123456-000

**Model:** SR47PCV **Radio:** Skydio Connect SL, Cellular

**Input:** 5-20VDC, 5A **Output:** 5-20VDC, 3A

**Power:** LiPo, 18.55VDC

**Contains FCC IDs:** 2ATQRSMODBV3

R17FN980

**REMOTE ID ENABLED**

**NDAA COMPLIANT**



### Skydio X10 Controller Serial Number

This begins with **X10CTRL-** and can be found on the label located on the back of the controller.

**Serial Number:** X10CTRL-1234

Assembled in the USA

 R-NZ

 **HDMI**  

**Model:** SC18V1

**Radio:** Skydio Connect SL

**Input:** 5-15VDC, 3A

**Output:** 5VDC, 3A

**Contains FCC IDs:** 2ATQRSMODBV3S

A3LSMS916U

**Contains IC ID:** 25280-SMODBV3S

(S) SER X10CTRL-1234

(17V) MFR 86PV4

(1P) PNO 920-123456-000

 201-240222

 D240034201



# Flight System Initialization

## Skydio X10 Battery Serial Number

This 16-character number can be found on the battery label below the QR code.



**INFO:** After an initial flight, you can also find the battery serial number listed in the Battery column under **Reports > Flights**.

## Assign Licenses

If you purchased add-on software packages, you will need to assign these software licenses to your drones.

### Step 1 - Select Settings

### Step 2 - Select Licenses

The Licenses page offers information about your license Purchase History including all active and expired licenses, how many have been assigned, and how many remain unassigned.

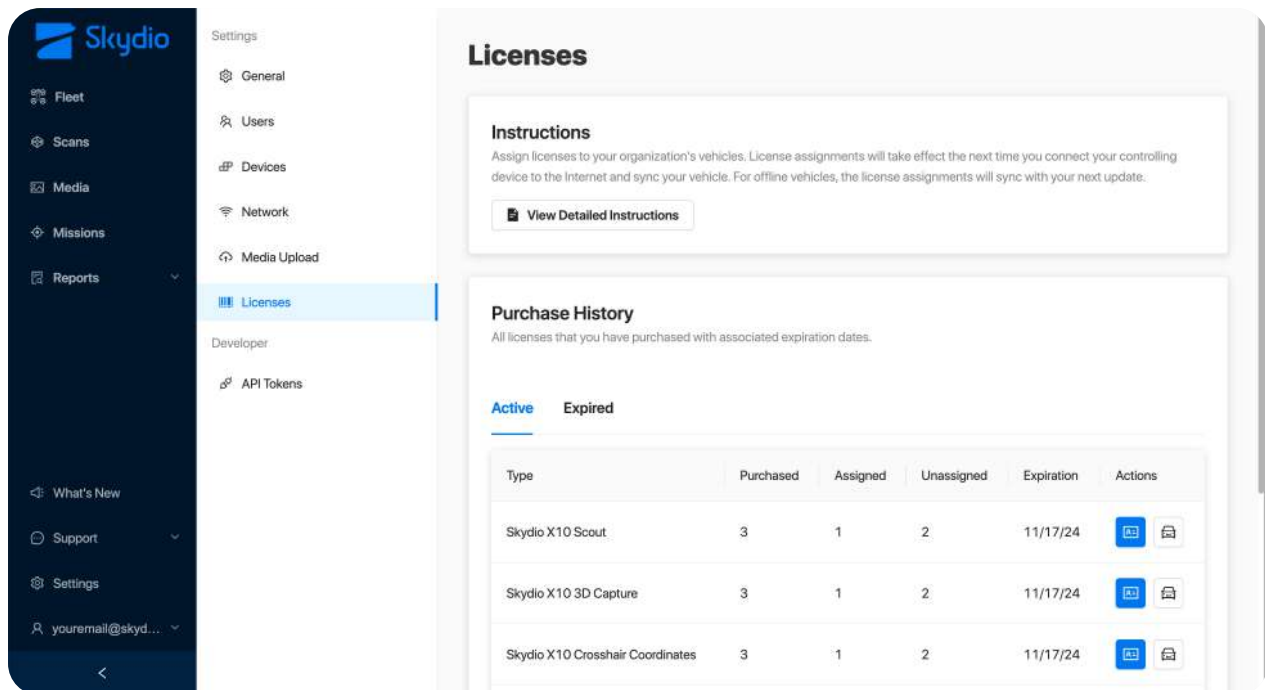

# Flight System Initialization

## Step 3 - Assign Licenses

Select the blue icon to assign that license to an eligible vehicle.

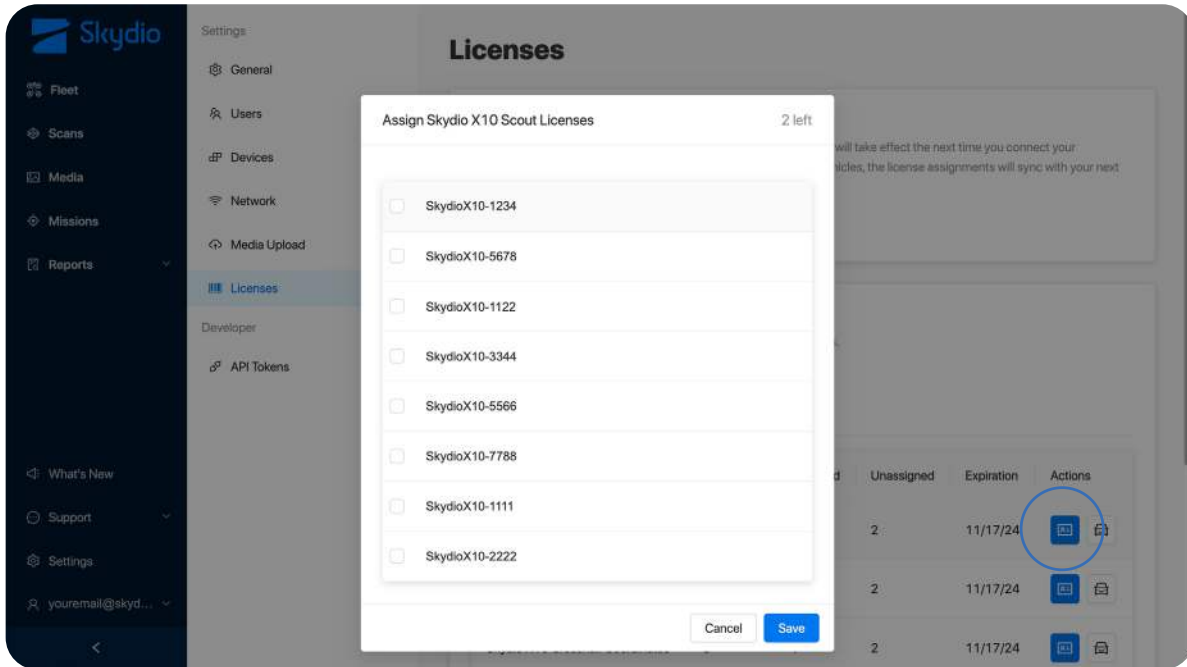

**INFO:** For more information about software licenses, visit [How to assign Skydio advanced software licenses in Skydio Cloud](#).

## Media Sync

If you have purchased Media Sync for your organization, you will need to add a wireless network and configure your media upload preferences.



**INFO:** For more information about setting up Media Sync, visit [How to use Media Sync in Skydio Cloud](#). You also have the ability to enable watermarks on your photos and videos. For more information, visit [How to enable watermark overlays in Skydio Cloud](#).

# Setting up Encryption without Physical Encryption Hardware



**CAUTION:** Skydio cannot recover lost passphrases. Losing a passphrase may make encrypted media unrecoverable. Always securely store your passphrase.

Cloud-managed SD card encryption uses organization-level asymmetric encryption keys (AEK) provisioned through Skydio Cloud.

This eliminates the need for physical encryption hardware (e.g., Yubikeys) while maintaining secure, identity-based access control. FIPS 140-3 validated encryption simplifies key management for large fleets.

If an SD card or drone is lost, stolen, or handled outside of authorized workflows, the encrypted media remains unreadable without the organization's encryption credentials.

- Private key material is securely provisioned to the drone
- Media is encrypted automatically; files are encrypted at capture (write time) on the SD card
- The drone must be unlocked before each flight to provision temporary key material required for operation
- Browser-based decryption workflows allow authorized users to decrypt media client-side
- Encryption does not affect Media Sync configuration

Additionally, Organization Admins and Pilots can remotely unlock an encrypted drone from its Device Page in Skydio Cloud (the drone must have an active network connection).

# Flight Crew Roles

## ORGANIZATION ADMIN

**Only Organization Admins can perform this setup in Skydio Cloud.** Organization Admins are responsible for:

- Enabling **Encrypt Drone Media** for the fleet (steps below)
- Creating and managing the organization's active encryption key, plus factory resetting the flight system if an encryption key is changed
- Includes setting and rotating the passphrase that protects access to the private key material
- If required, decrypt media via approved workflows by providing the passphrase in Skydio Cloud

## PILOTS

Pilots are responsible for unlocking encrypted drones before flight and following approved workflows when accessing encrypted media or logs.

- Unlock encrypted drones before flight
- Unlock media or Support Logs on-device when prompted

# Enable Encryption via Skydio X10 Controllers

**Step 1 - Navigate to Global Settings > Information**

**Step 2 - Select the name of the drone**

Located under Devices.

**Step 3 - Select Encryption**

**Step 4 - Select the Enabled option**

## Enable Media Encryption via Skydio Cloud

To enable Media encryption on Non-Docked systems, Organization Admins should:

**Step 1 - Navigate to Settings > Media in Skydio Cloud**

**Step 2 - Select the tab titled Non-Docked Systems**

**Step 3 - Enable the Encrypt Drone Media toggle**

The screenshot displays the Skydio Cloud Settings interface. On the left is a navigation sidebar with the following items: Settings, General, Users, Groups, Distribution Lists, Devices, Sites, Pathfinder Boundaries, Flight Settings, Network, Media (highlighted), Licenses, Alerts, Live Streaming, Post-Flight Report, Security, Simulator, Mid-flight Events, DFR, and Transparency Dashboard. The main content area is titled 'Media' and includes the subtitle 'Manage how the vehicle captures and uploads media.' Below this are three tabs: 'Global Settings', 'Non-Docked Systems' (selected), and 'Docked Systems'. The 'Non-Docked Systems Upload Policy' section contains four toggle switches, all of which are turned on: 'Images' (Upload photos captured on the device), 'Preview Video' (Upload smaller, preview video files (LRV) captured on the device for the full flight), 'Audio & Raw Video' (Upload audio and raw video files (MP4) captured on the device. One flight may be split into multiple MP4 files), and '3D Scan Data' (Upload models and metadata generated from 3D scans). Below this is the 'After Upload' section with one toggle switch, 'Delete files from the vehicle's SD card after upload', which is turned off. The 'Encryption' section contains two toggle switches: 'Encrypt drone media data' (highlighted with a blue circle and turned on) and 'Extra Unlock Conditions' (Automatically unlock the drone under certain conditions), which is turned off.

# Provision Encryption Keys in Skydio Cloud



**NOTE:** If an Organization Admin changes encryption keys, the drone must be factory reset. Rotating the passphrase does not change the active encryption key used by drones.

The Skydio Cloud passphrase is required to decrypt media in edge cases where the drone is unavailable but the SD card has been recovered, allowing authorized users to decrypt files through the approved browser-based workflow.

Only one active Cloud-managed encryption key can be used at a time.

### Step 1 - Navigate to Settings > Security

### Step 2 - Locate the Key Management tab at the top of the page

### Step 3 - Select Create a New Encryption Key

### Step 4 - Enter a secure passphrase for the encryption key

- This passphrase is required to unlock encrypted data
- **Securely store your passphrase** as Skydio cannot recover lost passphrases

### Step 5 - Select Create Key

- Once created, the key appears in the Key Management table with a status of **Active**
- A **Key ID** and **Key Fingerprint** are listed
- Only one active cloud-managed encryption key is used at a time

### Changing Encryption Passphrases



**CAUTION:** After rotation, the previous key will no longer work. Ensure all authorized users have access to the updated passphrase.

If the Organization Admin needs to change the passphrase protecting the encryption key:

**Step 1 - Select Rotate Active Passphrase**

**Step 2 - Enter a new secure passphrase**

**Step 3 - Select Rotate Passphrase**

### Unlocking Skydio X10

When encryption is enabled, Skydio X10 must be unlocked before flight operations can begin. After power cycles or postflight, the drone returns to a locked state and must be unlocked again.

Unlocking the system provisions temporary key material required for normal system operation. While the drone is locked, certain functionality, such as flight operations, media access, and Flight Skills, will be unavailable.

Selecting **Unlock and Fly Now** enables flight and system processes but does **not** decrypt the SD card. All files written to the SD card, including photos, videos, scan data, and support logs, remain encrypted at rest.

---

#### Locked Skydio X10

The drone cannot decrypt encrypted SD media.

Files are visible when connected via USB-C, but unreadable.

Media does not appear in the controller Media menu.

On-drone processes that require plaintext cannot run.

---

#### Unlocked Skydio X10

Drone can decrypt media encrypted with the currently provisioned key.

Media menu works.

Media Sync works.

USB-C/MTP access works (plaintext visible).

---

# Flight System Initialization

---

## Media Sync and Upload Behavior

When Media Sync is enabled:

- The drone is unlocked
- Media is transferred from the SD card
- Files are uploaded to Skydio Cloud in encrypted form

Encrypted files remain encrypted during upload. Data in transit is protected using industry-standard transport security (TLS 1.3).

Decryption of media files only occurs when explicitly initiated through an approved workflow (for example, the browser-based client-side decryption process using an authorized passphrase).

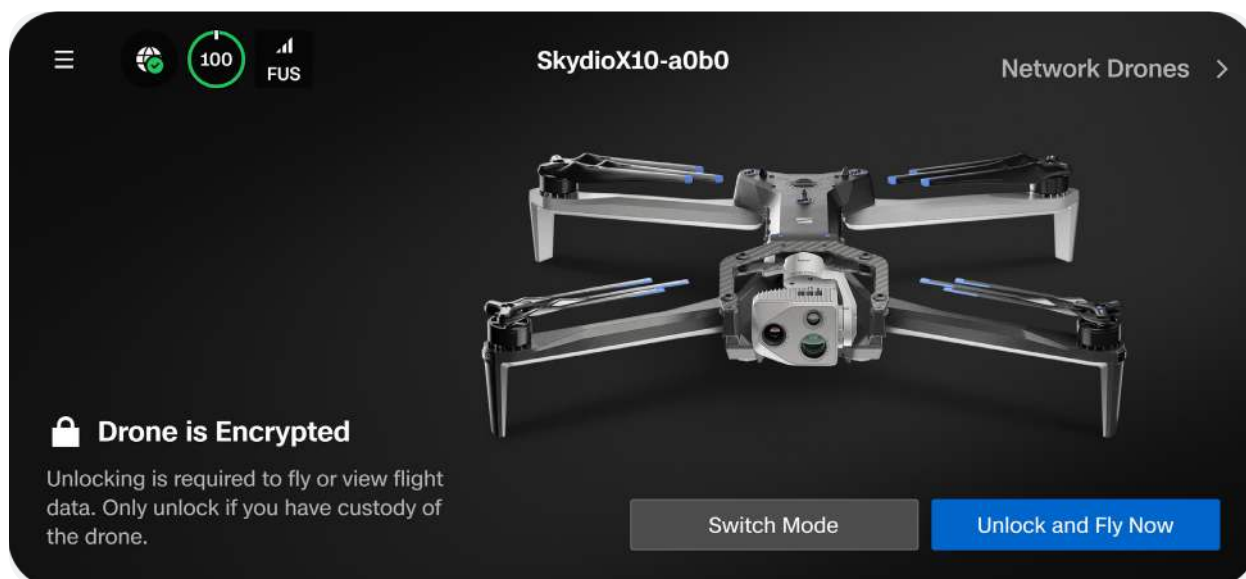

# Flight System Initialization

## Media

To decrypt Media, navigate to **Global Settings > Media > Unlock Media > Unlock**.

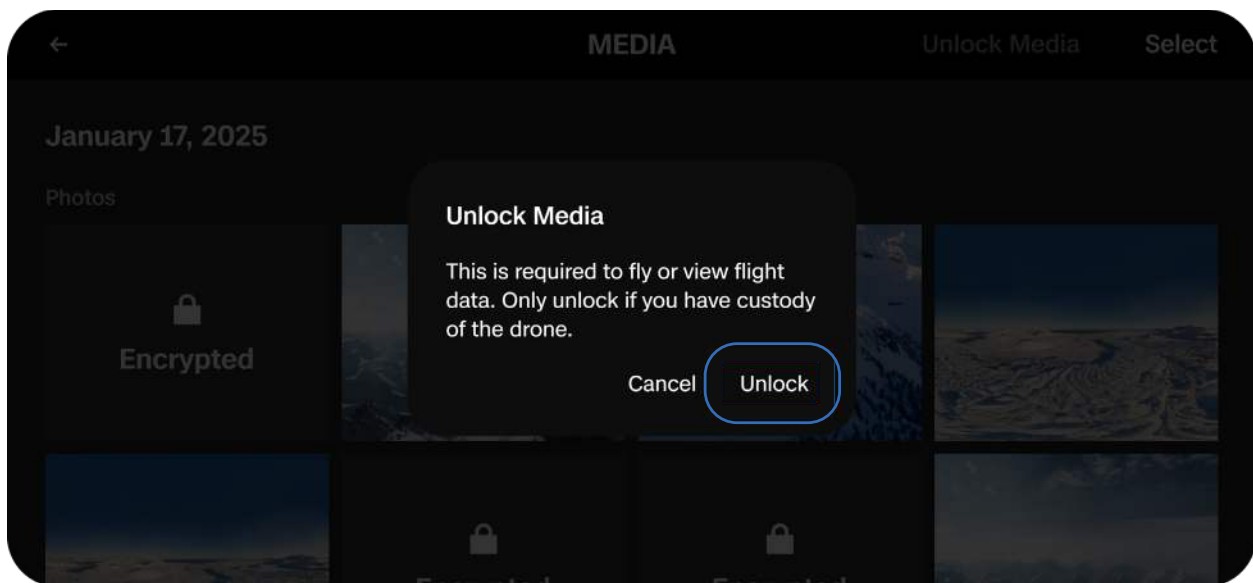
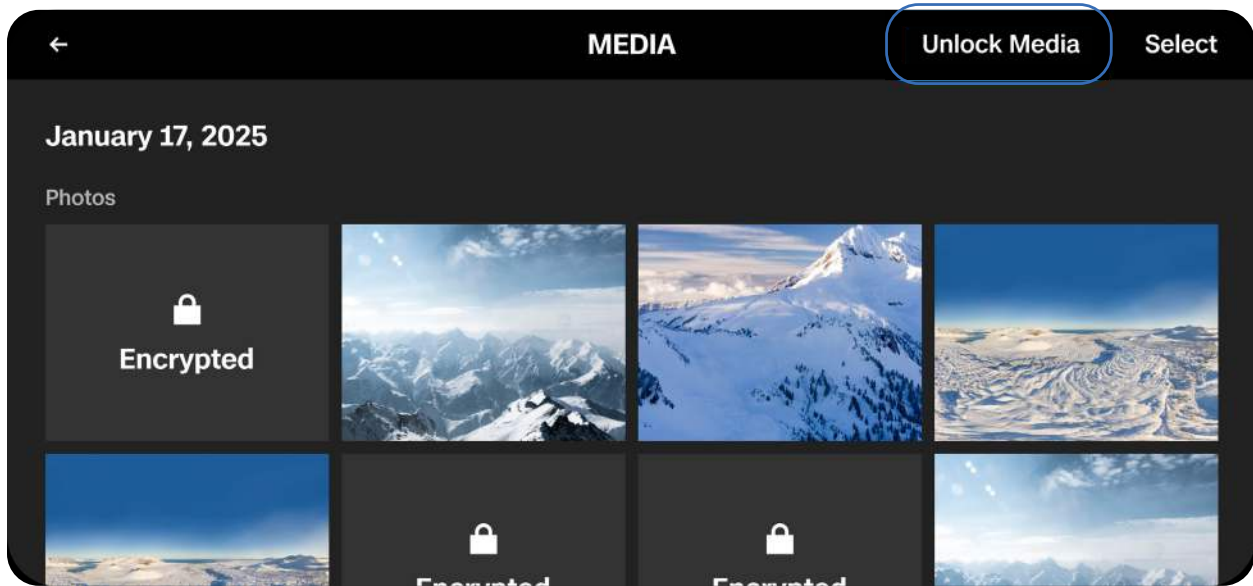

# Flight System Initialization

---

## Support Logs

To decrypt Support Logs, navigate to **Global Settings > Information > Skydio Support Logs > Unlock Logs > Unlock**.

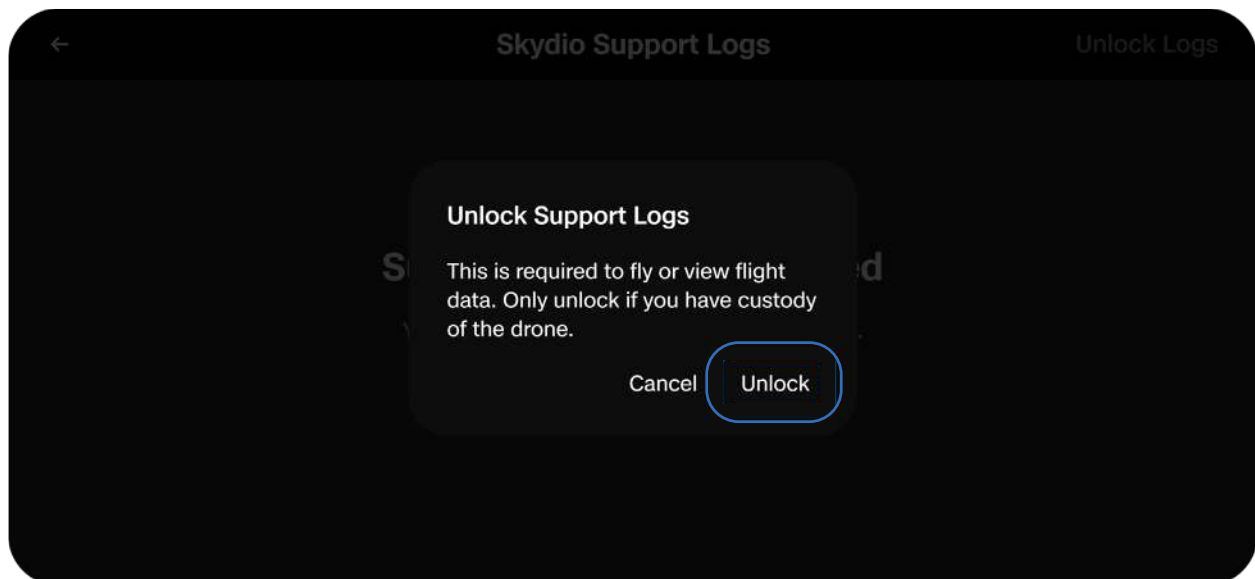

# Decrypting Files in Skydio Cloud



**NOTE:** Files encrypted using hardware-based key material cannot be decrypted using this workflow.

If the drone is unavailable (for example, damaged or unrecoverable) but the SD card has been recovered, Organization Admins can decrypt encrypted files using Skydio Cloud.

Files are encrypted at capture (write time) on the SD card. Skydio Cloud stores only encrypted media. When decryption is initiated, files are decrypted locally in your browser using the organization's passphrase.

This workflow allows you to access encrypted media even when Media Sync or standard upload processes are not available.

Organization Admins must:

- Know the organization's passphrase
- Have access to the recovered SD card files

### Step 1 - Navigate to Settings > Security

### Step 2 - Select the File Decryption tab

### Step 3 - Enter the organization's encryption passphrase

### Step 4 - Select Unlock Keys

### Step 5 - Decrypt files

Under **Step 2: Decrypt Files**, click **Select Files**. Drag and drop encrypted files from the recovered SD card (or browse to select them).

The files are decrypted client-side in your browser.

### Step 6 - Download the decrypted files for use

# Skydio X10 Setup

### Step 1 - Unfold the rear arms

Hold the drone with the sensor package facing away from you. Pull **laterally** away from the chassis until you feel the arm seat into place.

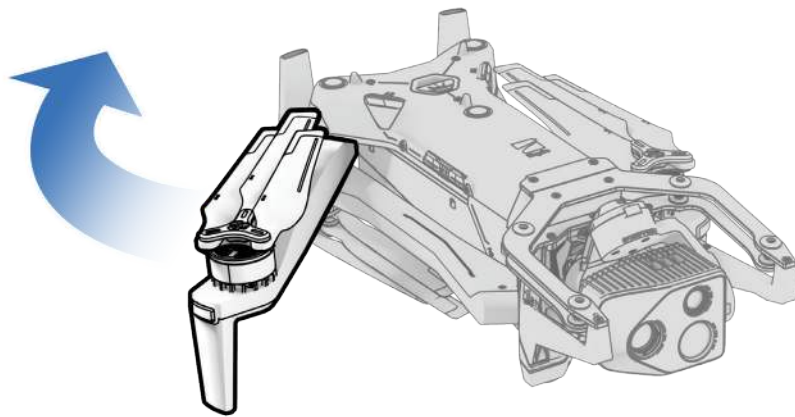

### Step 2 - Unfold the front arms

Push **down** and **forward**. Gently continue until you feel the arm seat into place.

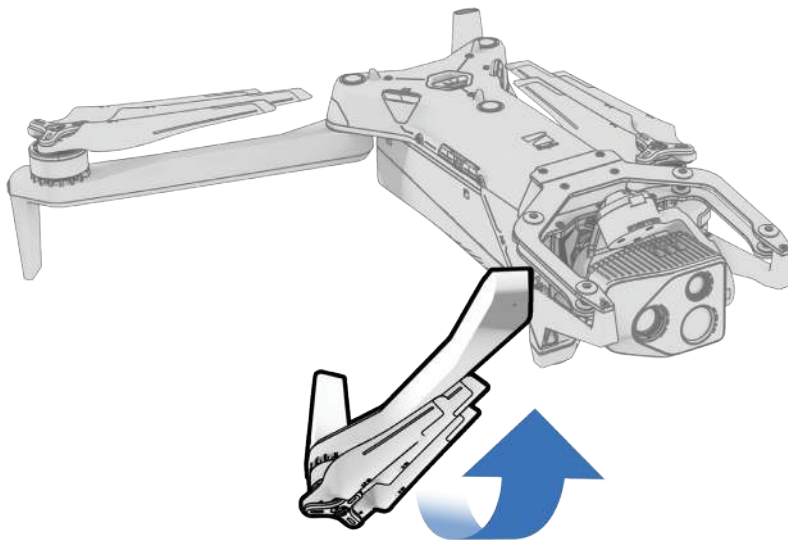

## Flight System Initialization

---

### Step 3 - Remove the red packaging stickers

There are red stickers located on the underside of each rear arm. Use the tab to gently lift and pull them off before flying.

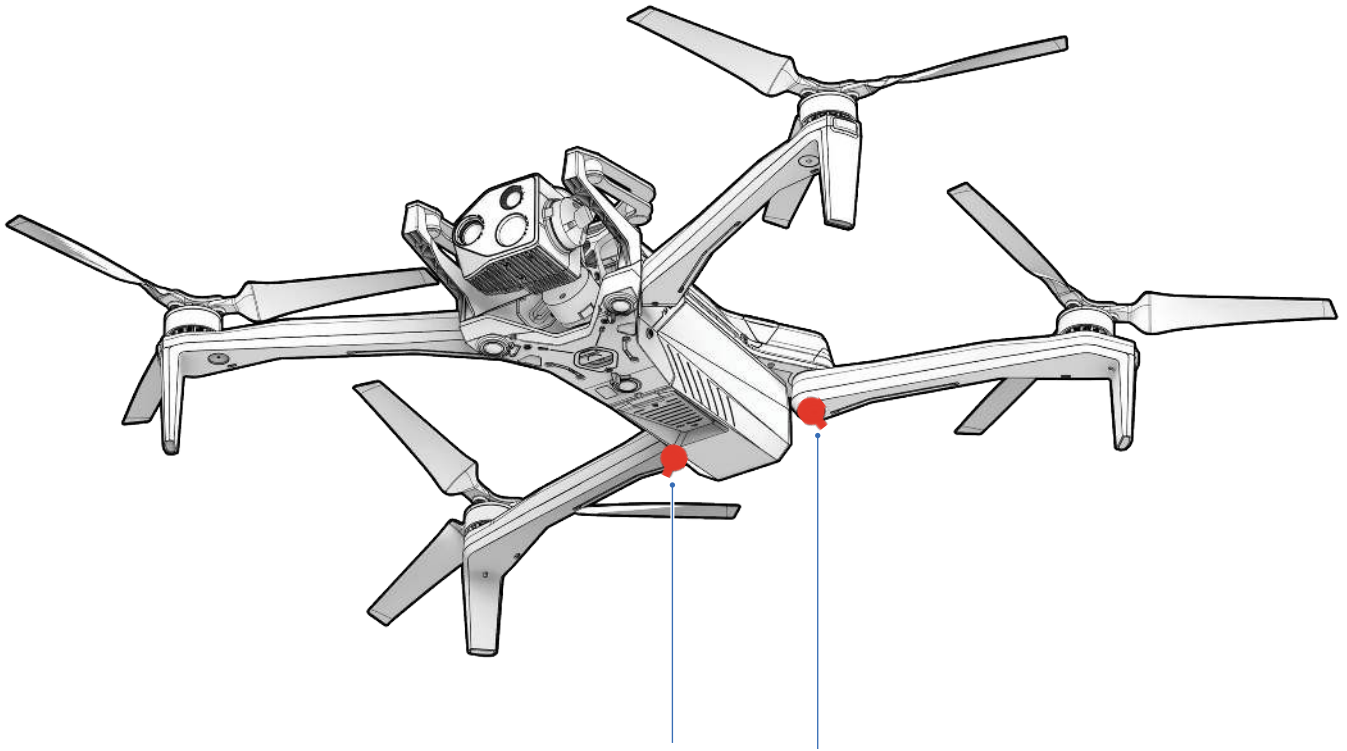

# Flight System Initialization

---

## Step 4 - Verify and format microSD cards (pre-installed)

Ensure you have two UHS Speed Class 3 (or faster) microSD cards inserted in the slots on the side of the drone.

- Minimum 256 GB
- Format your cards before flying using **Manage Data** within the **Information** menu (**Global Settings > Information > Devices > Manage Data**)

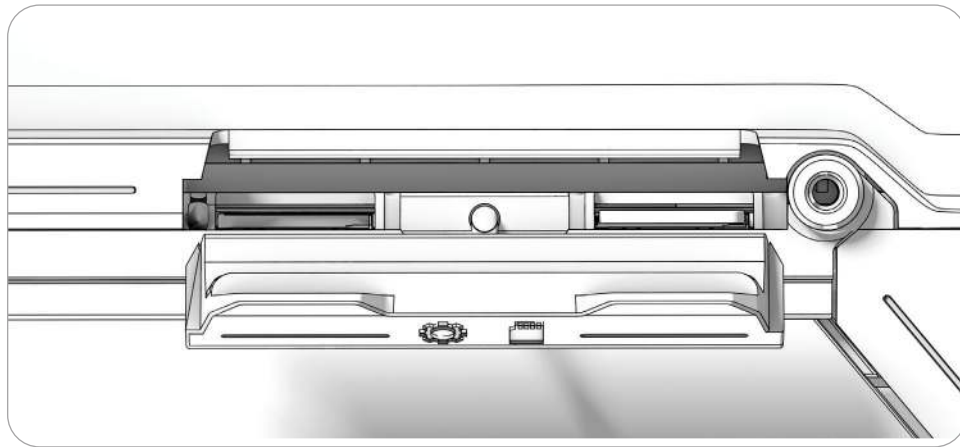

### Logs card

Supports software updates, scan data and records flight logs

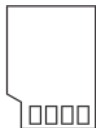

### Media card

Stores media captured during flight

## Flight System Initialization

---

### Step 5 - Insert battery

Align the battery with the rails and slide toward the sensor package until the magnets engage.

- Ensure the battery and rails are free of debris and interference
- Ensure the battery is completely seated before flying



### Step 6 - Remove the sensor package lock

Hold the sensor package and gently pull to remove from the top of your drone.

- Save this piece to reattach when storing or transporting

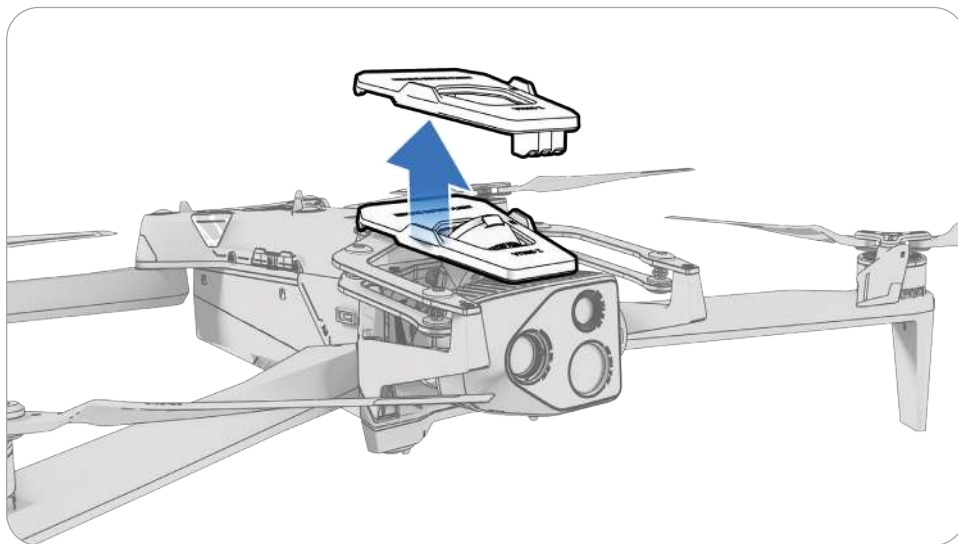

# Skydio X10 Controller Setup



Scan for more information about Skydio Connect Fusion/SL/5G.

## Step 1 - Power on the Skydio X10 Controller

Open the controller lid and hold the Power button for five seconds. The lights on the front of the controller will turn on and indicate the level of charge.

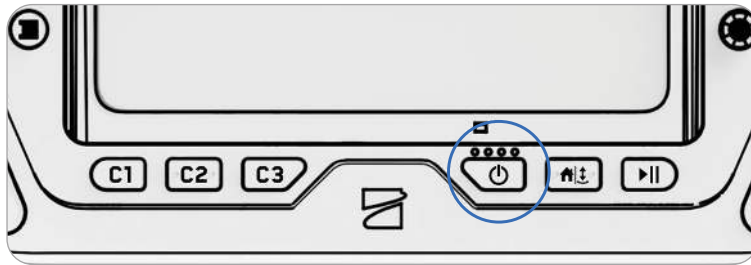

**NOTE:** While powered off, you can check the level of charge by pressing the Power button once.

## Flight System Initialization

---



**CAUTION:** To maintain operational security and prevent conflicts with controller functionality, never sign in to personal or third-party accounts (such as Google Drive, Gmail, OneDrive, or other cloud services) on the X10 Controller. If you need to import maps or export logs, use the supported workflows provided by Skydio.



**CAUTION:** The password cannot be recovered or reset. Ensure that your password is entered correctly and is written down and stored in a safe location. If the password is lost, the controller will need to be replaced.

### Step 2 - Set up Skydio Flight Deck

Skydio Flight Deck is the dedicated flight software on your controller. Follow the on-screen prompts to begin setup.

- Connect to a WiFi network
- Provide the email address associated with your Skydio Cloud account and enter the activation code sent to your email
- If your Organization Admin has [configured Single Sign-On \(SSO\)](#) via Skydio Cloud, you have the ability to log in using your organization's Identity Provider (IdP)
- Enable **Shared Controller** to let multiple accounts sign in to the same controller (optional; an Org Admin can do this at any time)
- Set a password for your controller (optional)

## Flight System Initialization

---

### Step 3 - Power on Skydio X10

Press and hold the Power button on the battery for three seconds. The lights on the drone arms will turn blue as X10 powers on.

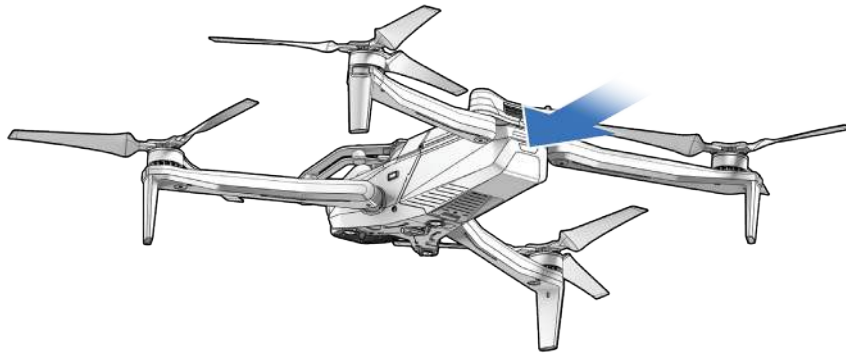

### Step 4 - Pair the drone and controller

Use the USB-C pairing cable to connect your devices. Wait as pairing completes. The lights on the drone will turn solid blue and the name of your drone will appear on the screen when pairing is successful.

Once paired, the drone and controller will automatically connect before future flights.

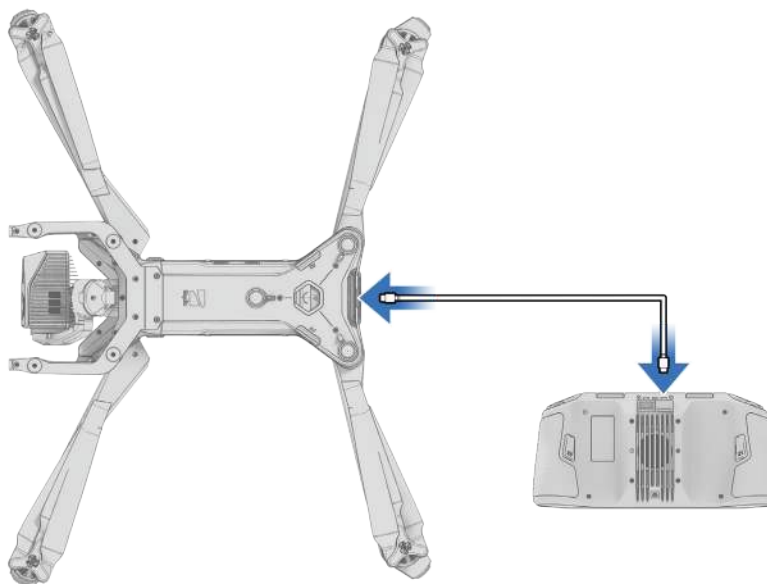

# Connecting Devices

Step 1 - Power on Skydio X10 and the X10 controller

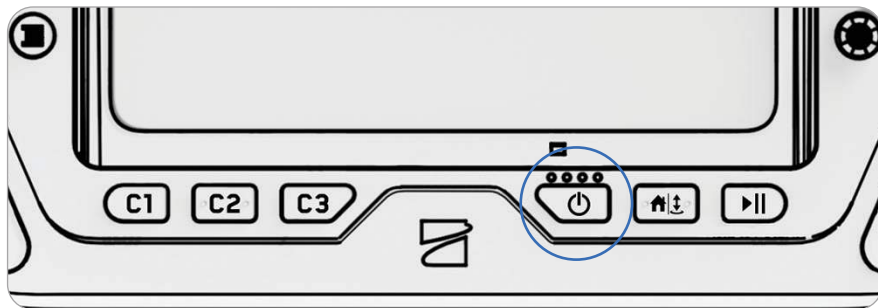
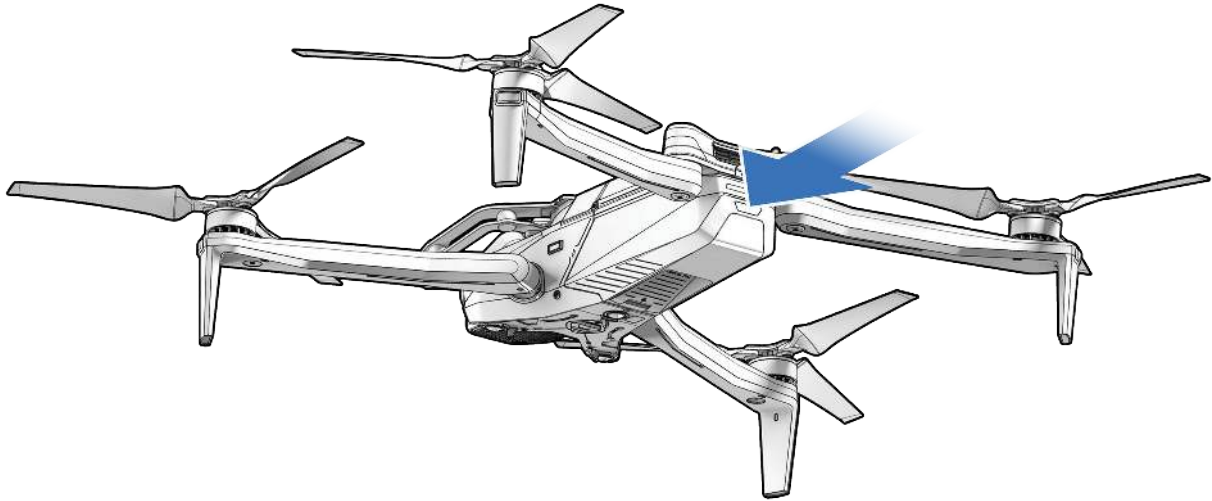

# Flight System Initialization

## Step 2 - Wait for devices to connect

A drone and controller that were previously paired will automatically connect.

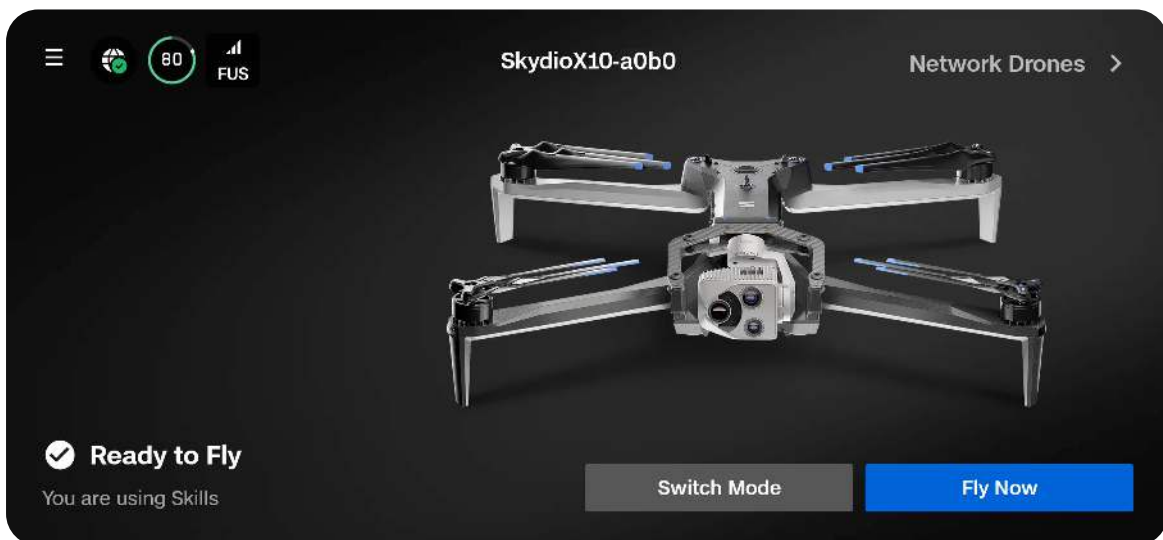

# Updating the Skydio X10 Controller



**NOTE:** Check for available updates before flying. You must update the Skydio X10 Controller first before updating Skydio X10.

### Step 1 - Power on the Skydio X10 Controller

Open the controller lid and hold the Power button for five seconds. The lights on the front of the controller will turn on and indicate the level of charge.

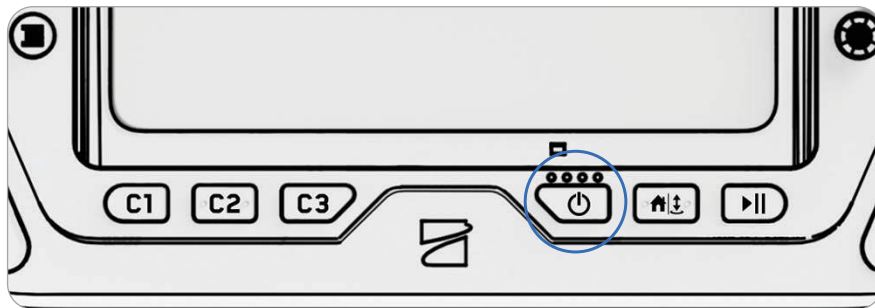

### Step 2 - Navigate to the Information menu

Located within Global Settings.

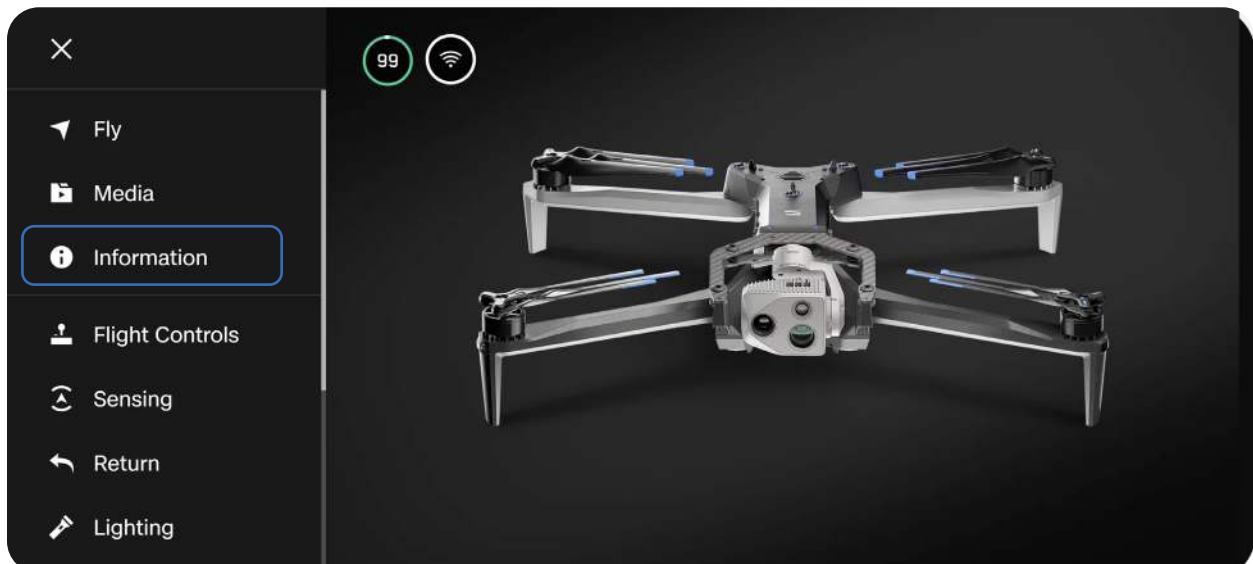

# Flight System Initialization

---

## Step 3 - Select Controller Update under Settings

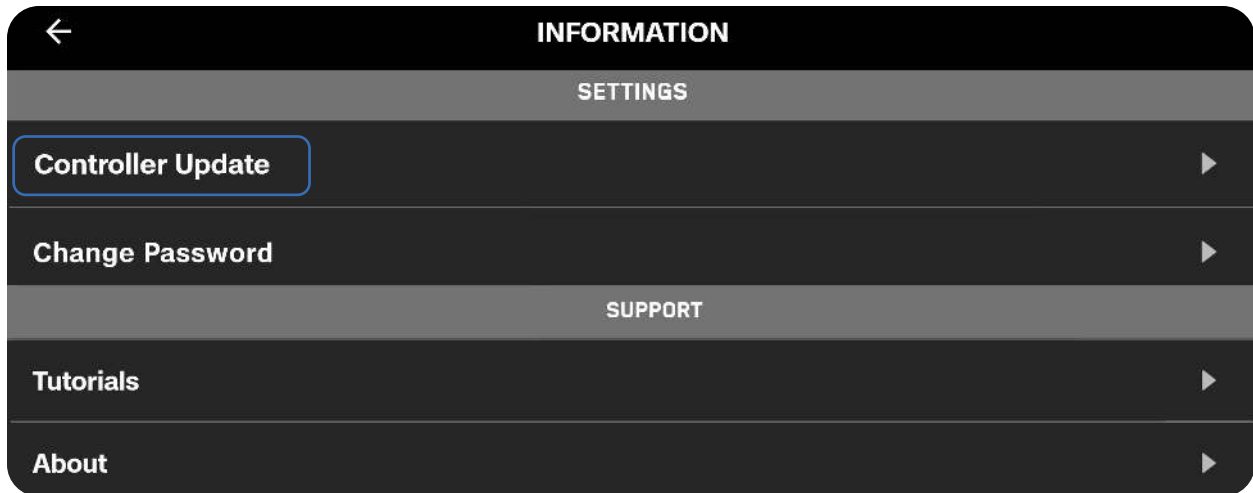

## Step 4 - Select Check for Update

## Step 5 - Select Update

Follow the on-screen prompts to update your controller.

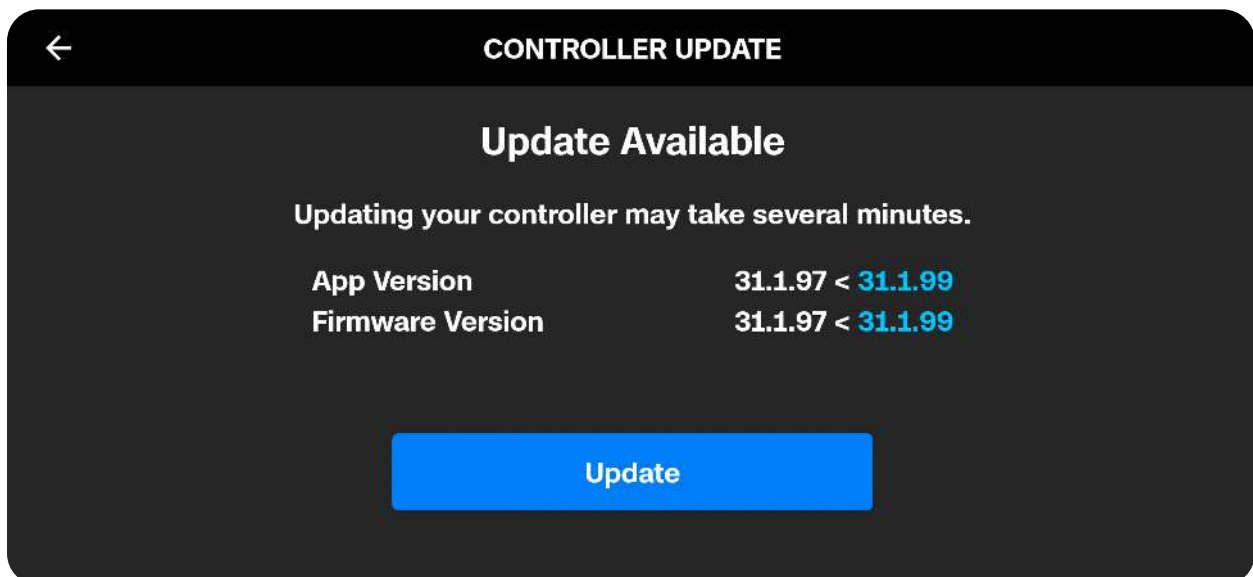

# Updating Skydio X10

Skydio will not force an update for your system, however, for optimal performance, we recommend that you keep your Skydio system up-to-date. If an update is available, you will see a red notification icon in the **Information** menu.

### Step 1 - Power on Skydio X10

Press and hold the Power button on the battery for three seconds.

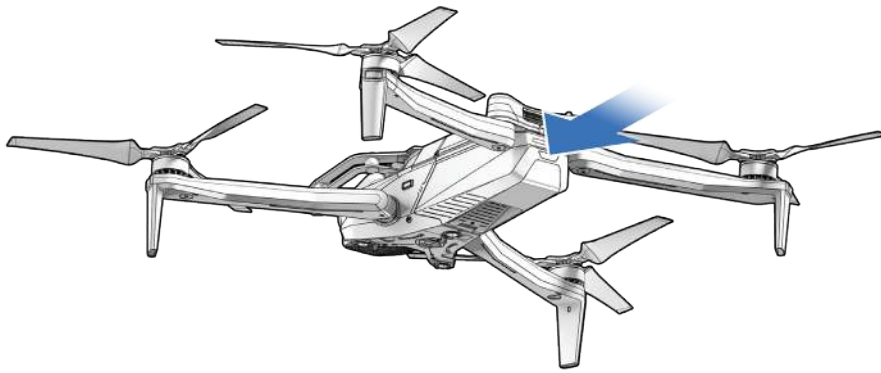

### Step 2 - Power on the Skydio X10 Controller

Open the controller lid and hold the Power button for five seconds. The lights on the front of the controller will turn on and indicate the level of charge.

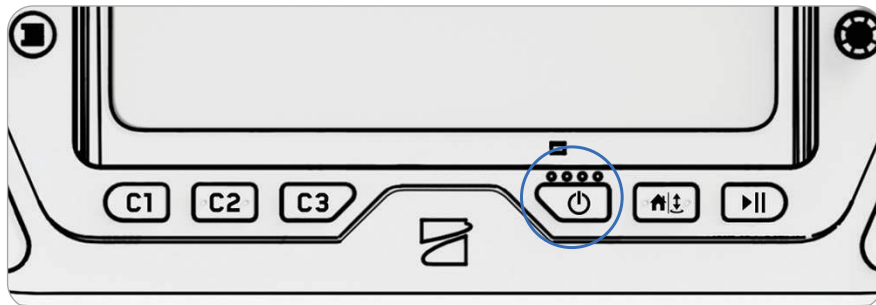

# Flight System Initialization

## Step 3 - Navigate to the Information menu

Located within Global Settings.

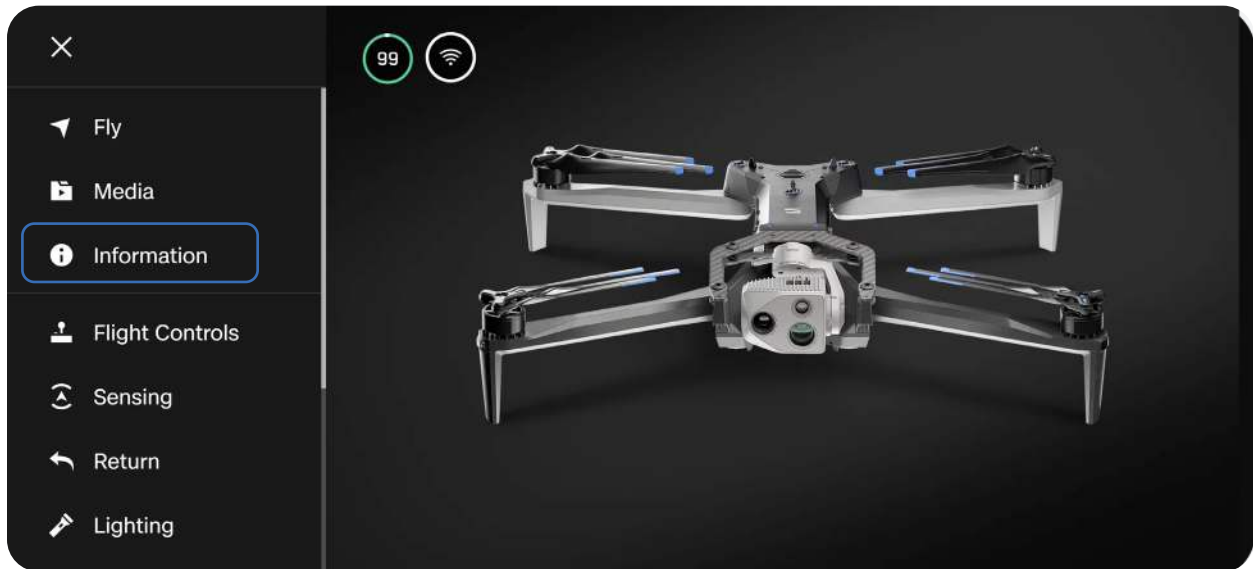

## Step 4 - Select your Skydio X10 under Devices

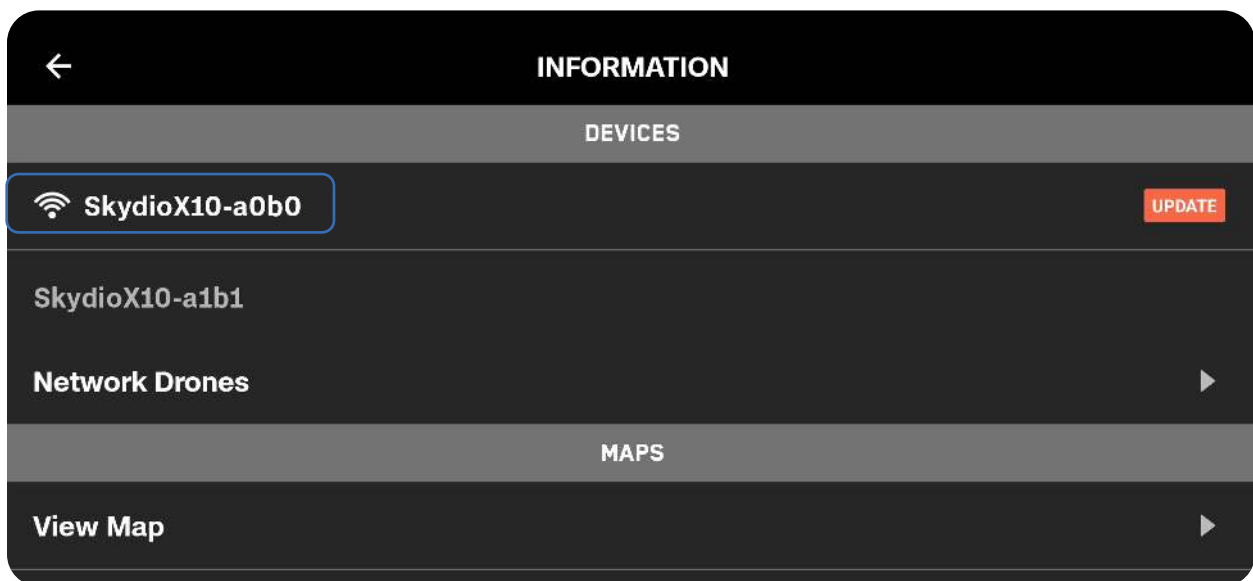

# Flight System Initialization

## Step 5 - Select Update

Follow the on-screen prompts to update your drone.

Select **Check for Updates** anytime to look for available updates.

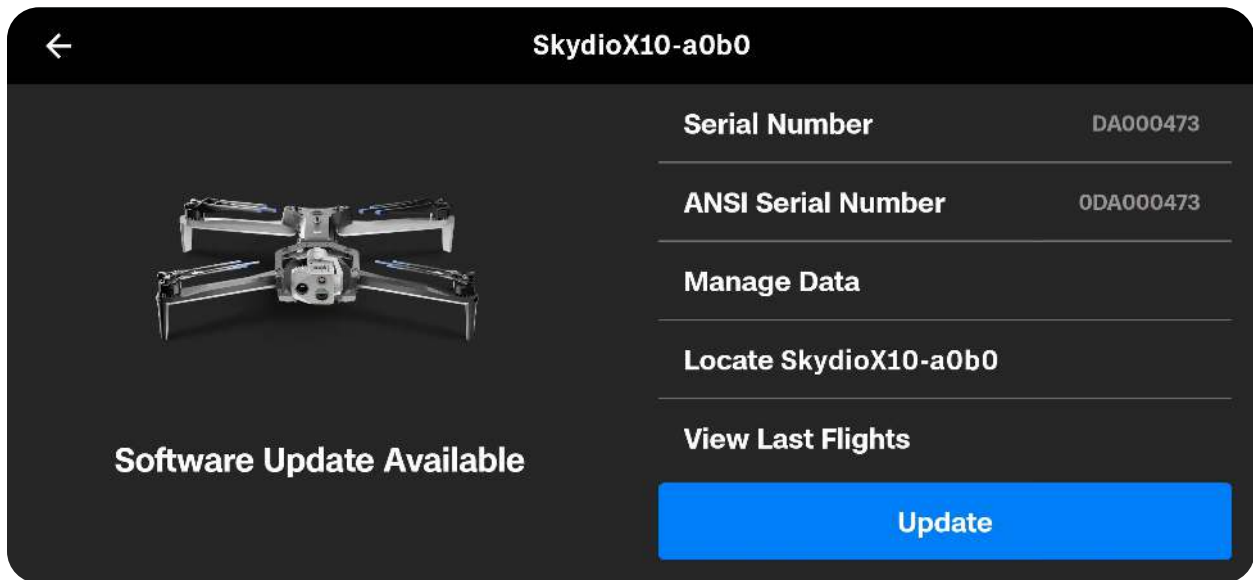

# Skydio Connect 5G Setup



**NOTE:** Flight over 5G Cellular is only available if you've purchased an X10 system with Skydio Connect 5G and subscription to Skydio Remote Flight Deck with Skydio Connect 5G.

### Step 1 - Enable 5G Cellular for your drone

On your X10 Controller, select the **Global Settings** menu and the **Radio** tab. Toggle on **Drone Connect 5G**.

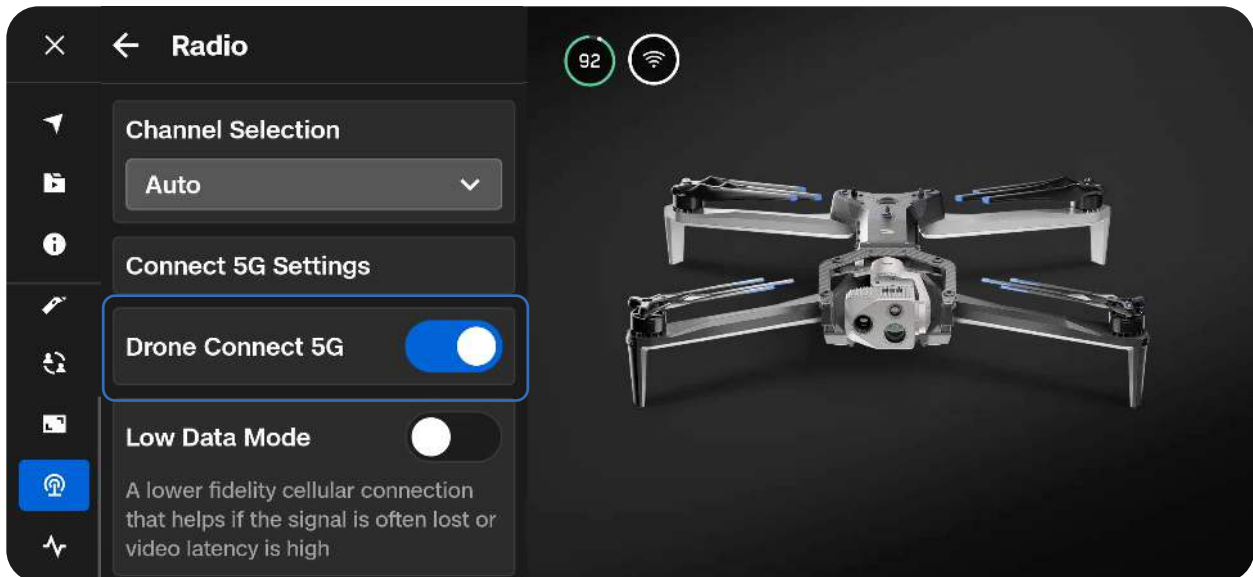

### Step 2 - Enable 5G Cellular for your controller

Select the **Global Settings** menu and the **Information** tab. Scroll down to **Device Settings**, select **Network**, then ensure **Cellular Data** is toggled ON.

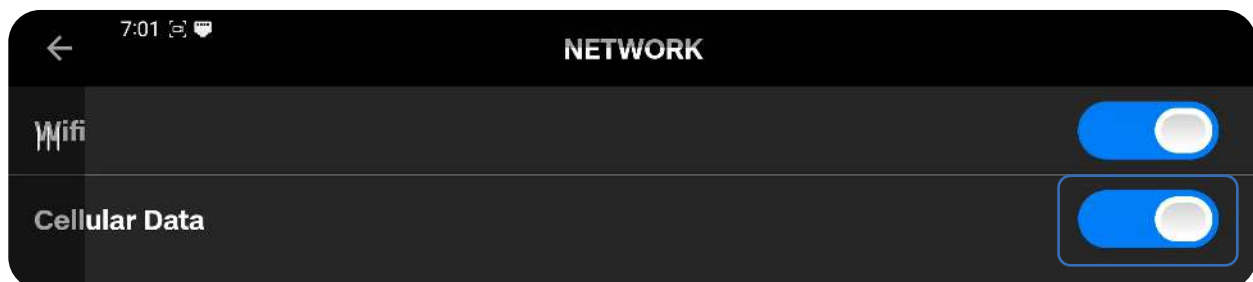

# Battery Warming in Cold Environments

For extremely cold environments, the Skydio X10 battery features self-warming technology to enable flight within 5 minutes.

If the X10 battery is below 32°F (0°C), Skydio X10 will be prevented from launching. You will need to pre-warm your batteries before you can launch.

- Battery self-warming is supported down to -4°F (-20°C).
- Skydio X10 will allow launching with reduced performance while continuing to operate the self-warmer until full performance is restored.
- A battery must have at least 30% charge to self-warm.
- A fully charged battery is strongly recommended when flying in cold weather.
- Flight time will be reduced in cold temperatures.
- Minimize aggressive maneuvering in extremely cold environments.

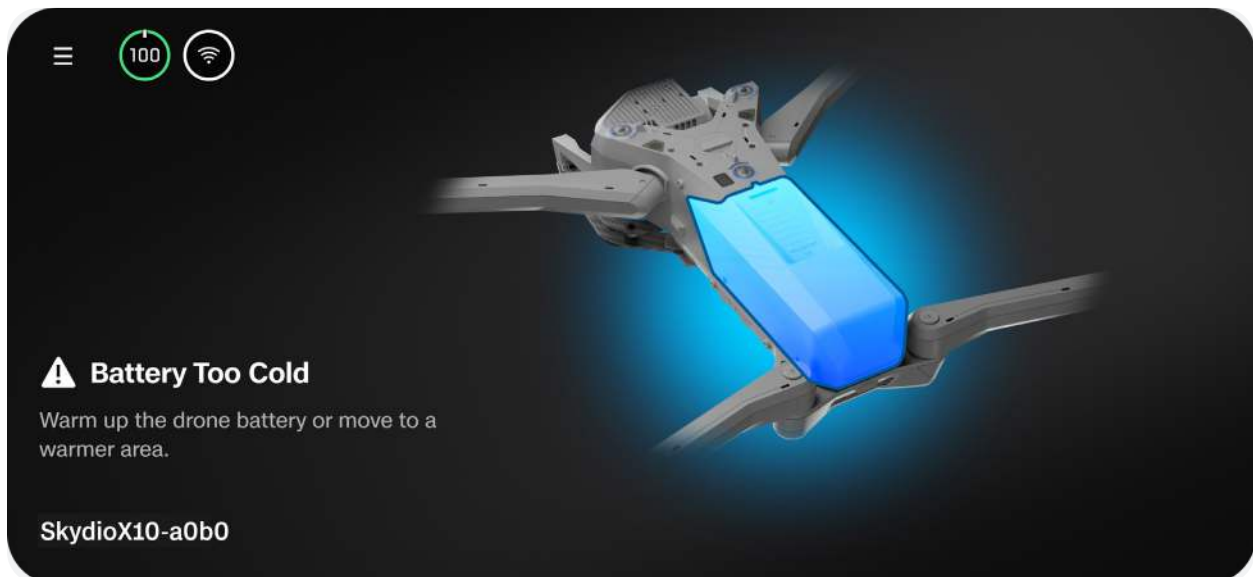

### Pre-warming Skydio X10 Batteries

If Skydio X10 detects that a battery is too cold to launch, the battery will automatically begin self-warming. Launch will become unblocked when the battery is sufficiently warmed for the given state of charge.

You also have the option to prewarm a battery before inserting into the drone:

#### **Step 1 - Triple tap the battery button to begin the self-warming process**

- The lights on the battery will turn orange during the self-warming process
- Triple tapping again will end the self-warming process

#### **Step 2 - If the battery is cold enough it will begin self-warming**

- When self-warming is complete, the lights on the battery will briefly turn blue and then power off

#### **Step 3 - Insert the battery into the drone and power on**

- If the self-warming was still in progress prior to inserting, it will continue while the battery is in the drone
- Launch will become unblocked when the battery is sufficiently warmed for the given state of charge

# Remote ID

Remote ID requires drones operating in U.S. airspace to identify themselves by broadcasting information that will enable the authorities to identify commercial operators flying under Part 107.

Drones requiring FAA registration and weighing more than 0.55 pounds must have a Remote ID digital license plate consisting of the drone's serial number or a session ID specific to a particular pilot and flight. Drones will be required to broadcast that information, as well as the position of the drone and controller. The information will be broadcast locally; however, only authorized individuals from public safety organizations may request the identity of the drone's owner from the FAA.

Remote ID is enabled for Skydio X10 systems. You will see a label signifying RID compliance in the battery tray.



## Additional Resources

- [How to register your Skydio drone at FAA DroneZone](#)
- [What is RemoteID and how does Skydio have you covered?](#)

# ADS-B Alerts

**Automatic Dependent Surveillance–Broadcast (ADS-B)** is a surveillance technology that enables situational awareness of nearby crewed aircraft. Skydio X10 is equipped with an onboard ADS-B In receiver, which detects ADS-B Out signals broadcast by crewed aircraft. This allows the X10 Controller to display nearby air traffic in real-time and issue alerts when traffic enters a pilot-defined proximity.

ADS-B traffic awareness is required for Beyond Visual Line of Sight (BVLOS) operations from the controller. This capability **supports waiver compliance by providing both visual and audible alerts when aircraft are nearby**, helping you avoid conflicts and maintain a safe distance.

Use ADS-B to:

- **Check the airspace before launching** – View real-time positions of other aircraft on the map before flight
- **Maintain situational awareness during flight** – Monitor air traffic as it approaches your area of operation
- **Respond to audible alerts** –If a crewed aircraft enters your defined alerting range, take appropriate action (e.g., descend to a safe altitude)

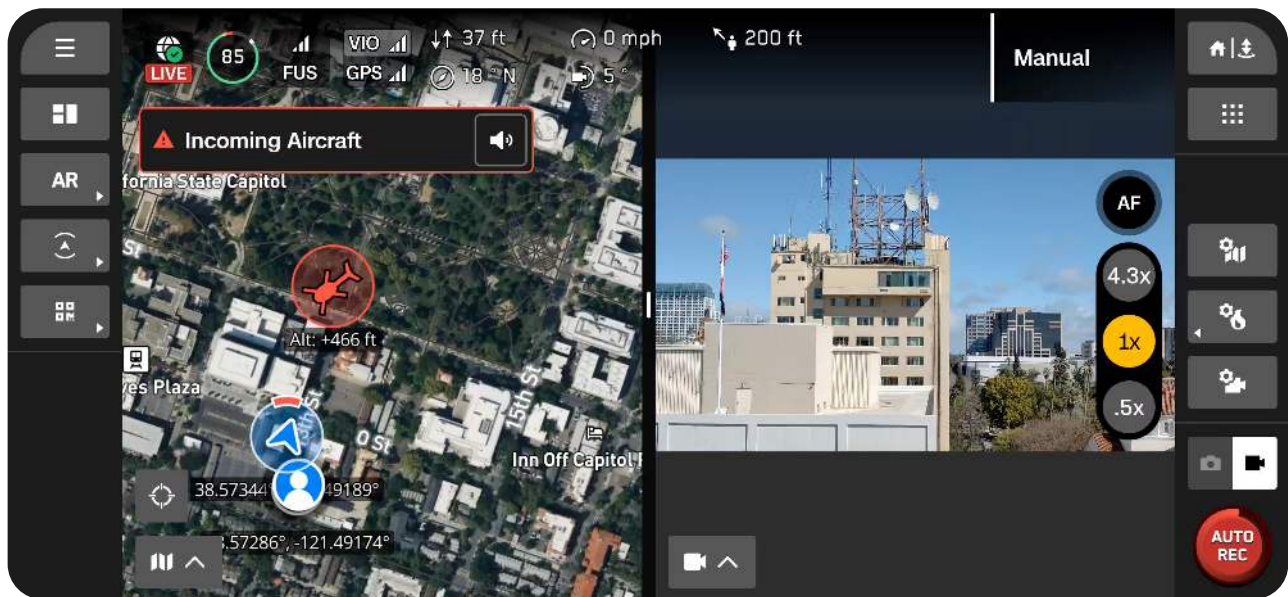

### Setting ADS-B Alert Ranges

When an aircraft enters the alert radius, a notification will appear on the controller:

**Aircraft icon** – Displays either a fixed wing aircraft or rotorcraft

- Shows the altitude **relative** to your drone
- Select this icon to view more flight details (e.g., vertical/horizontal speed, ground distance relative to your drone)

**Visual notification** – An alert appears in the top left of the screen and displays **Incoming Aircraft**

**Audible alert** – When an aircraft enters your alert radius, the X10 Controller will play an audible beep, along with a spoken “Traffic”

- Mute this alert within the notification, or mute all notifications using the **Sound** menu (within Global Settings)

#### Step 1 - Navigate to the Display menu

Located within Global Settings.



# Inflight Operations | Navigating Skydio Flight Deck

## Step 2 - Select Air Traffic

Use this menu to configure your ADS-B alert range.

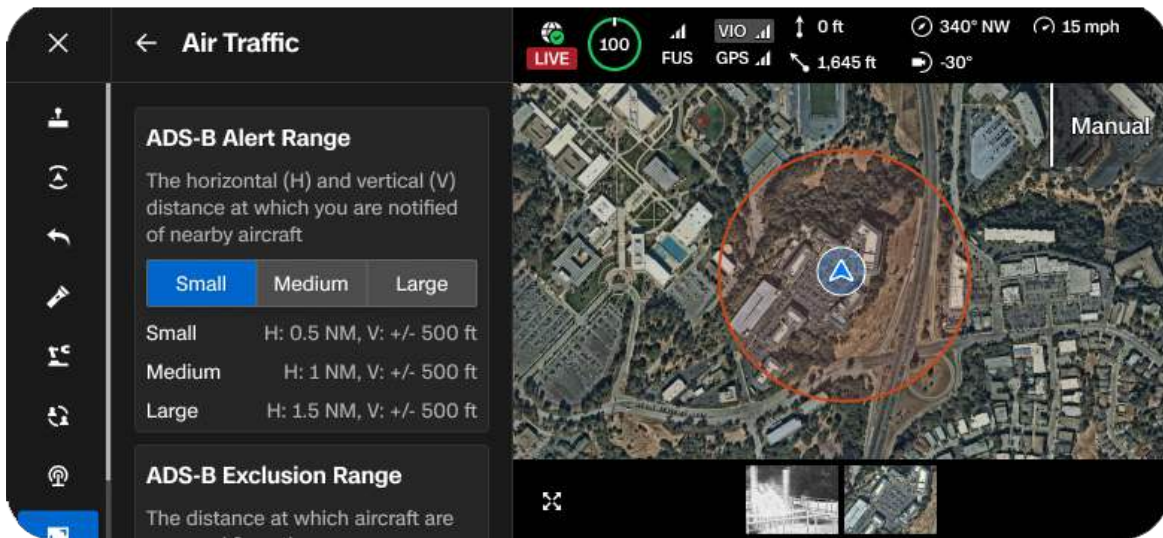
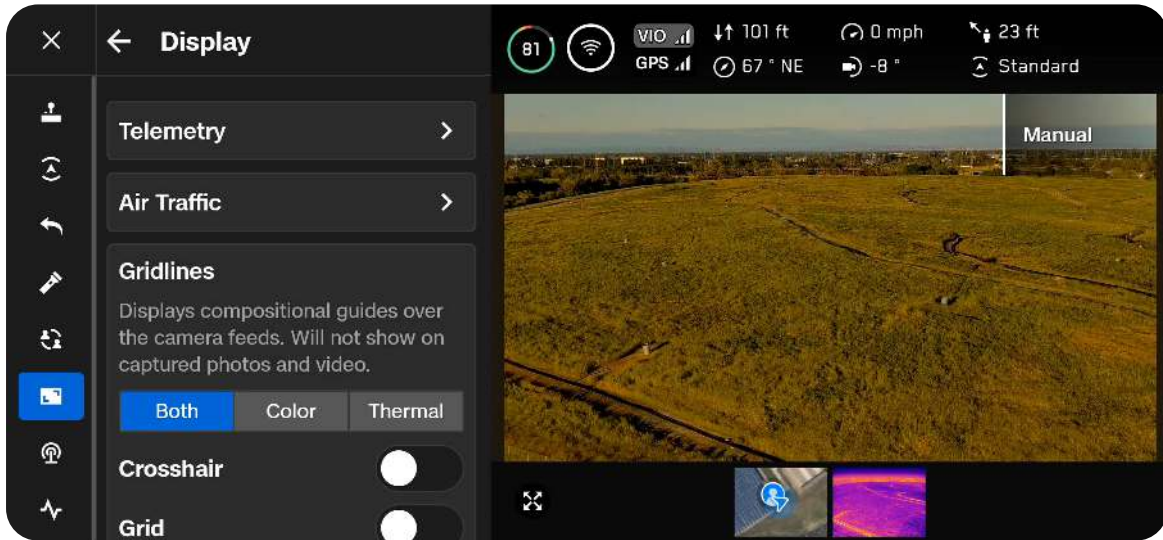



# Operations Planning

*Relevant Flight Crew Role(s): Organization Admin, Pilot in Command (PIC)*

Operations Planning prepares the flight crew to execute missions safely, efficiently, and predictably before arriving onsite.

## This section covers

---

How to Import and View Custom Map Layers

---

Downloading Maps

---

Creating Waypoint Missions

---

Pre-planning and Syncing Map Capture Missions from Skydio Cloud

---

# Overview

Operations Planning prepares the flight crew to execute missions safely, efficiently, and predictably before arriving onsite.

During this phase, Pilots define mission objectives, configure autonomous flight parameters, and ensure required data and mission files are available on the X10 Controller. Proper planning reduces field setup time, minimizes configuration errors, and enables repeatable flight execution.

Operations Planning should be completed prior to entering the Preflight phase.



**NOTE:** Base maps and layers are limited to 15 files to prevent excessive storage usage on the controller.

# How to Import and View Custom Map Layers

Adding a custom map layer enables you to display critical information, such as mission boundaries, wildfire zones, or asset locations, as visual overlays on the Skydio X10 Controller. Use customer map layers in flight to improve situational awareness and stay aligned with operational requirements.

Supported map formats include:

- KML/KMZ
- GeoJSON
- GeoTIFF
- GeoPDF
- MBTiles

In the Map Library, you will see Base Maps and Map Layers:

- **Base Maps** - Displays the maps that were downloaded via Information > Download Maps (e.g., Mapbox tiles)
- **Map Layers** - Displays imported map files that will be used as custom layers

### Operational Considerations

- Map layers are visual only and do not affect flight paths or mission logic.
- Newer imports are listed above previously imported layers. Layers cannot be reordered.
- Layers dynamically hide or display depending on the zoom level to maintain optimal rendering and readability (i.e., layers disappear at lower zoom levels).
- Large or vector-heavy files may cause short lag when enabling or disabling.
- Unsupported or corrupt files will display an import error.
- The name of the map file is the name that will display on the X10 Controller and cannot be changed.
- KML/KMZ styling (color, shading) may not always be preserved.
- Deleting old layers frees storage and improves performance.
- For best visibility, import opaque layers first, followed by transparent ones.
- After importing, map layers persist between flights, reboots, and users.

### Tips and Best Practices

- Press and hold on the name of a layer to automatically center and zoom the map to that layer's boundaries (the map will center even if the layer is currently not visible).
- Upload opaque map layers before transparent ones to maintain layer visibility.

# Map File Details and Transparency

**Map layers are visual references only.** They do not modify flight paths, mission logic, or geofence boundaries.

- **Layer order:** Newer layers display on top of previously imported layers. Reordering is not currently supported.
- **Transparency:**
  - Vector formats (KML, KMZ, GeoJSON) support transparency and can stack visually.
  - Raster formats (GeoTIFF, GeoPDF) are opaque and may obscure layers beneath them.
- For best results, import large raster layers first, then overlay transparent vector layers.
- **MBTiles:** May contain either raster or vector tiles. Transparency depends on how the file was created.
  - Vector tiles → transparent
  - Raster tiles → opaque
- **Zoom-dependent visibility:** Some layers will automatically hide when zoomed too far in or out. This is expected behavior to maintain map readability.
- **Persistence:** Layers remain available between reboots and user sessions, as long as they are not manually deleted.
- **Performance:** Rapidly toggling multiple large layers may cause short UI lag or slower rendering.

# How to Import Map Layers

Step 1 - Save map files to a USB-C drive

Step 2 - Insert the USB-C drive into the back of the controller

Step 3 - Navigate to Global Settings > Information > Map Library

Step 4 - Under Map Layers, select Add New Map Layer (+) to load supported files

- The name of the map file is the name that will display on the X10 Controller
- Upload opaque map layers before transparent ones

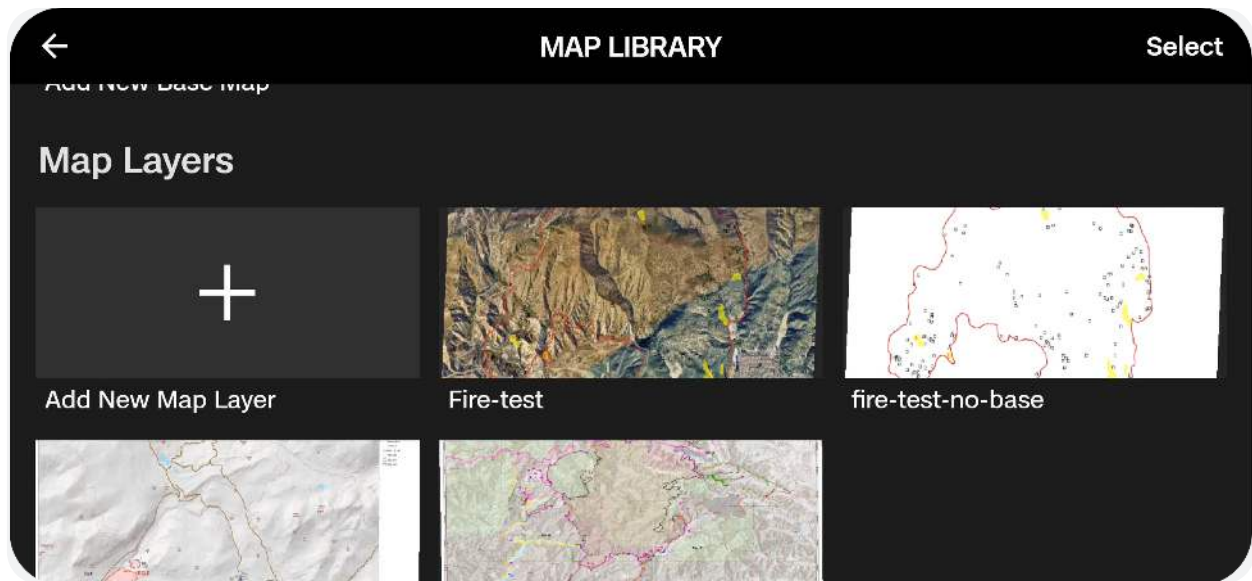

**NOTE:** Large files (e.g., GeoPDF or GeoTIFF) may take several minutes to upload depending on file size. As a general guideline, allow about one minute per 10 MB of file size during import.

## How to Enable or Disable a Map Layer Inflight

### Step 1 - Select the Map Settings icon

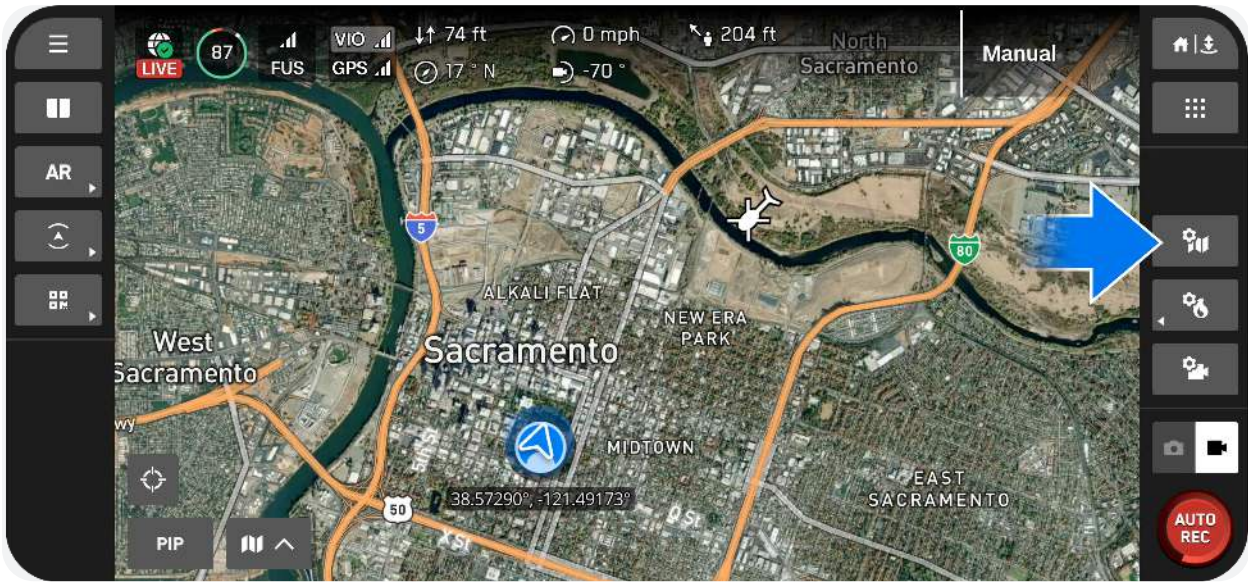

### Step 2 - Select Layers

- A list of imported layers will appear
- Use the eye icon to show or hide layers

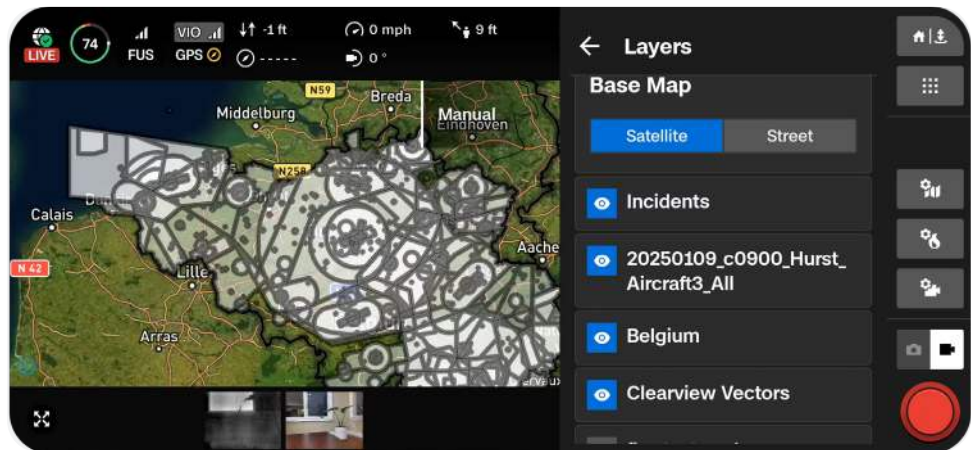
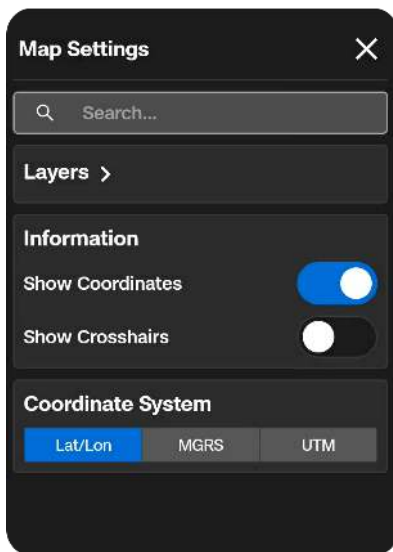

# Viewing and Managing Map Layers

During flight, select the Map Settings Icon > Layers to view a list of your layers. Use the eye icon to enable or disable markers.

- Toggle, preview, or remove map layers at any time

# Deleting a Map Layer

Navigate to the Map Library, select the layer, and select **Delete**.

- Removing unused layers frees up storage space

# Downloading Maps

Downloaded maps will be 3.5 x 3.5 square miles, centered around the target point even if you are zoomed in. Your map will appear in the Map Library once the download is complete.

**Step 1 - Select the blue (+) icon under Add New Maps and a satellite view of your current location will display**

**Step 2 - Drag and pinch-to-zoom on the map until your desired location is centered on the screen**

**Step 3 - Use the search bar to enter coordinates or type a location**

**Step 4 - Select Download Maps to save**

# Creating Waypoint Missions

Pre-planning a Waypoints Mission allows you to use GPS coordinates to design and execute multi-waypoint missions.

Waypoint Missions can be created before a flight or during flight, but only one will be saved at a time. Waypoint Missions can be created using the Maps Menu or while actively flying.

## Creating a Waypoint Mission from the Maps Menu

This option is accessed by navigating to **Global Settings > Information > Maps**.

### **Step 1 - Select Waypoint Mission**

### **Step 2 - Navigate to the location on the map where the mission will occur**

Select the Map Icon to search or enter coordinates.

### **Step 3 - Hold on the map to add the first Waypoint**

Select Add Waypoint.

### **Step 4 - Continue adding Waypoints until your mission path is complete**

Select a Waypoint to edit the location, altitude, heading, or gimbal pitch or delete.

### **Step 5 - Launch**

### **Step 6 - Open the Flight Skills menu and select Waypoints**

### **Step 7 - Select the blue Start button**

If the drone is not at the Waypoint Mission location, it will automatically begin flying to the first waypoint.

# Creating a Waypoint Mission during Flight

**Step 1 - Launch**

**Step 2 - Navigate to the location on the map where the mission will occur**

**Step 3 - Open the Flight Skills Menu**

**Step 4 - Select Waypoints**

**Step 3 - Hold on the map to add the first Waypoint**

Select Add Waypoint.

**Step 4 - Continue adding Waypoints until your mission path is complete**

Select a Waypoint to edit the location, altitude, heading, or gimbal pitch or delete.

**Step 5 - Select the blue Start button**

# Pre-planning and Syncing Map Capture Missions from Skydio Cloud

Organization Admins or Pilots can create Map Capture missions in Skydio Cloud before arriving onsite, share and sync them to the X10 Controller, adjust as-needed in the field, and fly them using the standard Map Capture workflow.

Map Captures created in Skydio Cloud can be edited on the X10 Controller. If a Pilot edits the Map Capture boundaries or settings on the X10 Controller, the edits will automatically sync to Skydio Cloud when the controller is connected to the internet. No manual sync action is required. Skydio Cloud will display the timestamp of the most recent sync.

## Operational Guidelines

- **Pilots must be within 5 miles (8 km) of a Map Capture mission's location to begin the scan.** Missions located more than 5 miles from the drone will still load in the Scan Library. However, an error will occur when selecting **Begin Scan**.
  - Confirm the position of the drone relative to the mission area before starting the scan.
- **Always verify the Height Ceiling of the drone before starting a Map Capture mission.** If a pre-planned mission in Skydio Cloud is set **above** the configured Height Ceiling within the X10 Controller settings, the mission will still load, but the scan altitude will **automatically adjust to 3 ft (1 m) below the Height Ceiling**.
  - Confirm the Height Ceiling within **Global Settings > Flight Controls**. If needed, adjust the Height Ceiling or update the scan altitude before starting the mission.
- Ensure the controller is online to receive newly shared Map Captures.

# How to share Skydio Cloud Map Captures

### Step 1 - Create a Map Capture Mission in Skydio Cloud

Log in to Skydio Cloud and navigate to **Missions > Create New Mission > Select Map Capture**.

Draw the mission boundaries, configure capture settings, and save the mission.

### Step 2 - Share the Mission with a Pilot

From the Missions tab, select the three vertical ellipses and select Share.

Search for and select the Pilot(s) who should receive the mission. Once shared, the Map Capture is available to the selected pilot(s) and will sync to their X10 Controllers when powered on and connected to the internet.

### Step 3 - Sync Missions to the X10 Controller

Power on the X10 Controller and connect to the internet. Navigate to **Global Settings > Information > Scan Library**.

Verify the mission appears in the **Map Capture Missions from Cloud Missions** section.

- The Scan Library displays the time of the last sync
- Ensure the controller is online to receive newly shared missions

### Step 4 - Review Return Behavior and optionally edit the Map Capture



**CAUTION:** Return settings from the Cloud mission are ignored when this mission is flown from a controller. Review Return Behavior in the controller.



**NOTE:** Edits to a pre-planned Map Capture mission on the X10 Controller automatically sync to Skydio Cloud when the controller is connected to the internet. No manual sync action is required.

Choose the synced Map Capture from the Scan Library and select **Open Scan**.

You will see a preview of the Map Capture, along with the ability to optionally **Edit Settings**.

- If you change any scan settings, you will be prompted to save the changes before launching

Select **Begin Scan**.

### Step 5 - Launch and begin scanning

Cloud-synced scans use the same Map Capture workflow as missions created directly on the controller. The drone will determine the flight path based on the Launch Point.



# Preflight

*Relevant Flight Crew Role(s): Pilot in Command (PIC)*

Complete a series of preflight checks to ensure the system is airworthy, the environment is safe, and the flight system's configuration reflects operational requirements.

**This section covers**

---

Start of Shift Checklist

---

Preflight Checklist

---

Confirm Devices are Paired

---

Maximum Wireless Performance

---

# Overview

Prior to conducting operations using Skydio X10, the PIC must complete a series of preflight checks to ensure the system is airworthy, the environment is safe, and the flight system's configuration reflects operational requirements.

Some tasks only need to be completed once at the beginning of the operational shift, while others must be performed before each individual flight. Separating these two phases streamlines workflows and helps maintain a high standard of safety and situational awareness.

---

	A set of tasks intended to confirm that the overall system is ready for operations.
<b>Start of Shift Checklist</b>	This includes verifying logins, inspecting the physical condition of the drone, and confirming the site is safe to launch from.
	This is a set of tasks focused on confirming real-time conditions and mission-specific details.
<b>Preflight Checklist</b>	This includes factors that change throughout the day, such as reviewing connectivity, weather, and airspace status.

---

# Start of Shift Checklist

At the start of their shift, Pilots should follow these processes.

## Log in to Skydio Cloud

Pilots should visit [cloud.skydio.com](https://cloud.skydio.com), enter the email address associated with their organization, retrieve the verification code sent to that email, and enter it into Skydio Cloud.

Pilots should confirm that they are signed in with the proper credentials for their organization and that the features needed for the shift can be accessed.

The Pilot's current **Organization** is listed in the top left corner.

- If they have access to multiple organizations, Pilots should select the drop-down arrow to view a list of their organizations
- They can easily switch organizations by selecting one from the list and entering the email verification code

The email address of the logged-in user is shown in the bottom left corner.

- The drop-down arrow allows Pilots to view the organization that is associated with this email

## Verify Health Status of Fleet (Fleet Page)

Before conducting operations, Pilots must verify that the flight systems they intend to use during the shift are fully operational.

If a device is in **Limited Operation** or **Inoperable**, the system may need maintenance.

## Preflight

---

To verify the health status of the fleet:

### **Step 1 - Navigate to the Fleet page (located in the left sidebar)**

### **Step 2 - Review Fleet health status**

The Fleet Page provides a snapshot view of the flight systems, allowing users to quickly identify Sensor Packages, Attachments, and overall system health.

Status levels include:

- **Online** - No known issues; system is ready for flight
- **Offline** - System is disconnected
- **Limited Operation (yellow)** - Some functionality is restricted (e.g., a battery is nearing end of life); the system can fly, but maintenance may be needed soon
- **Inoperable (red)** - A critical issue is preventing flight; immediate action required

Hovering over a Limited Operation or Inoperable status displays details about the issue (e.g., Front Camera Failure).

### **Step 3 - Device: Review detailed system information**

Here, more detailed information about the flight system can be viewed. If any indicators were shown that communicated limited or poor health for the flight system, then more information can be found by selecting the gear icon for the drone.

Device Settings for the drone can also be configured here (such as enabling Remote Operations).

# Check for Temporary Flight Restrictions (TFRs) in the Flight Area

In special circumstances, the FAA may temporarily restrict access to certain designated areas of your airspace.

These airspace restrictions are called [Temporary Flight Restrictions](#) (TFRs) and are communicated to pilots through [Notices to Airmen](#) (NOTAMs).

They restrict aircraft (including drones) from operating without permission in a certain area for a limited time. **Pilots must always check NOTAMs prior to their flight.**

- Pilots can check NOTAMs at: <https://notams.aim.faa.gov/notamSearch/nsapp.html#/>
- Pilots can check for TFRs at: <https://tfr.faa.gov/>

# Check Current and Forecast Weather Conditions from an Aviation Weather Source

Pilots must check current and forecasted weather conditions from an Aviation Weather Source such as the Aviation Weather Center. Weather conditions must be within the operating limits of the drone.

Pilots should check weather conditions in all potential flight areas and maintain awareness of upcoming weather throughout their shift.

# Complete Internal Processes

Pilots should complete any additional preflight workflows or documentation required by their organization's standard operating procedures (SOPs).

These requirements may vary depending on agency policies, waiver compliance, or mission type.

# Preflight Checklist

## Physical Inspection



**WARNING:** Carefully inspect your drone and environment before launching to ensure a safe flight.

- **Inspect the chassis** to ensure it is free of damage.
- **Inspect drone arms** and verify they are fully extended and free of damage.
- **Inspect the battery** and confirm it is securely seated prior to launching. Skydio X10 uses magnets to seat the battery which may attract metallic debris. Ensure the connector pins are free of debris or damage.
- **Clean the camera lenses and time of flight sensor** with a clean microfiber cloth. Cameras should be dust and smudge-free before flight.
- **Fan out the propellers and inspect** to verify they are firmly attached and properly seated in the motors and spin freely. Propellers should be free of cracks or damage. Do NOT fly with damaged propellers.
- **Inspect the sensor package** before powering on and ensure it moves freely and is not damaged, and **remove the Gimbal Stabilizer Clip** before flying.
- **Ensure all USB-C and microSD card seals are secured** over the ports.
- **If using an attachment, inspect the connections** and confirm cables are fully seated and thumb screws are secure. Loose or partially connected cables may detach during flight and cause damage.
- **Check your surroundings** before launching to ensure a safe environment for flight.
- **Point the controller cover/antennas toward the drone** for maximum wireless performance.
- **Verify batteries and the controller are fully charged** before flying.
- **Check for drone and controller updates** before flying.

# Confirm Devices are Paired

### Step 1 - Power on Skydio X10 and the X10 Controller

### Step 2 - Wait for devices to connect

A drone and controller that were previously paired will automatically connect. If devices are not paired, use the USB-C pairing cable to connect your devices.

- The lights on the drone will turn solid blue and the name of your drone will appear on the screen when pairing is successful

## Maximum Wireless Performance (Skydio Connect SL)

For maximum wireless performance when flying over a direct link, always maintain a direct line of sight between the controller and Skydio X10. Point the controller cover toward the drone, especially when flying at close range high altitude.

Signal strength and maximum control range may be affected when flying in areas with electromagnetic interference.

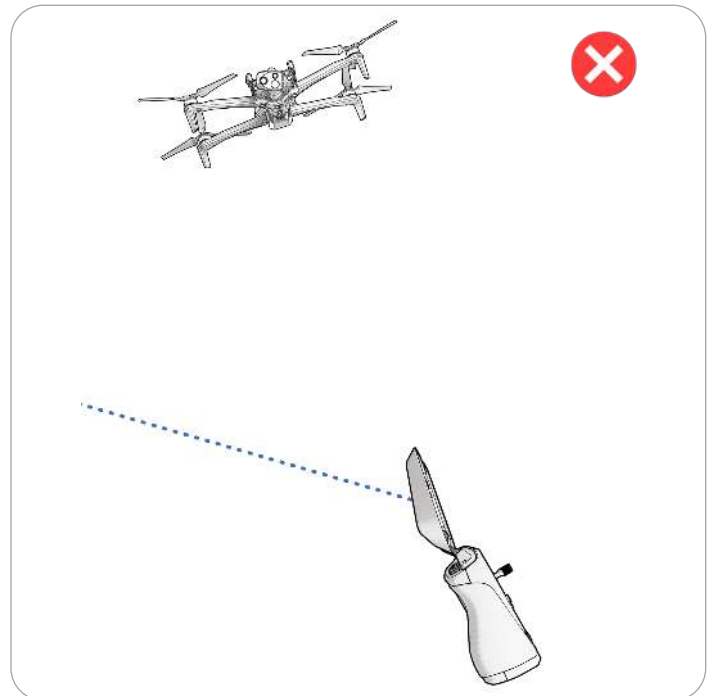
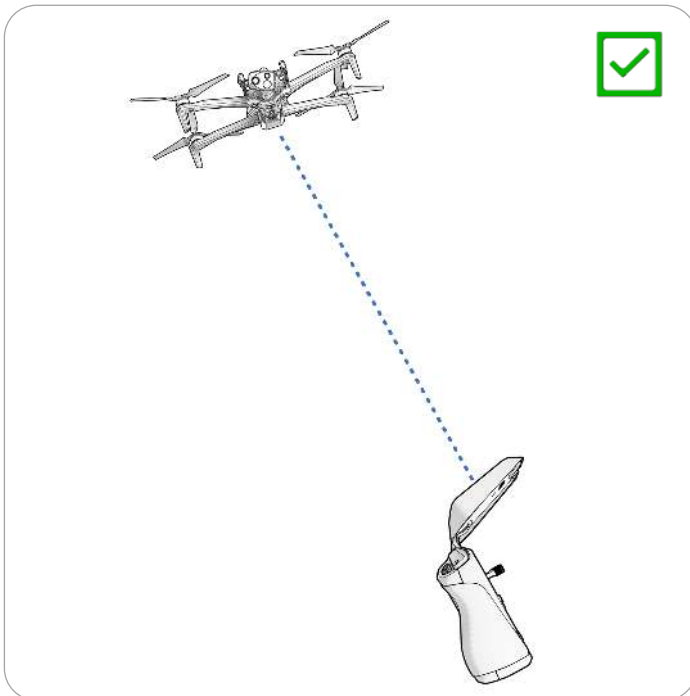



# Inflight Operations

***Relevant Flight Crew Role(s):*** Pilot in Command (PIC)

Covers the active control of a Skydio X10 during a flight. As the drone is airborne, the PIC is responsible for maintaining safe, stable, and compliant operations throughout the flight.

**This section covers**

---

Navigating Skydio Flight Deck

---

Flight Controls

---

Display

---

Radio

---

System Status

---

Quick Actions

---

Inflight Map

---



---

Camera Settings

---

Thermal Camera and Tools

---

Launching

---

Flight Screen

---

Flight Skills

---

Flying at Night

---

Flying in Precipitation

---

Low Battery

---

Returning and Landing

---

# Overview

The **Inflight Operations** phase covers the active control of a Skydio X10 during a flight. As the drone is airborne, the PIC is responsible for maintaining safe, stable, and compliant operations throughout the flight.

PICs must be prepared to respond to changes in weather, connectivity, and nearby air traffic while maintaining situational awareness through Skydio Flight Deck on the X10 Controller. Clear expectations around telemetry or contingency behaviors helps ensure each flight is completed safely, even if conditions change mid-air. Pilots should always monitor system status throughout the flight.

# Navigating Skydio Flight Deck

**Skydio Flight Deck** is the dedicated flight software on your controller. In this section you will learn about core menu locations and setting customizations.

Pilots must understand:

- Gate Screen
- Global Settings
- Flight Controls
- Return Behaviors
- Sensing (Obstacle Avoidance)
- Display
- System Status
- Quick Actions

## Gate Screen

After powering on and connecting to your drone, the first screen you will see is the **Gate Screen**. This screen is the first step to starting your flight, switching modes, or configuring preflight settings.

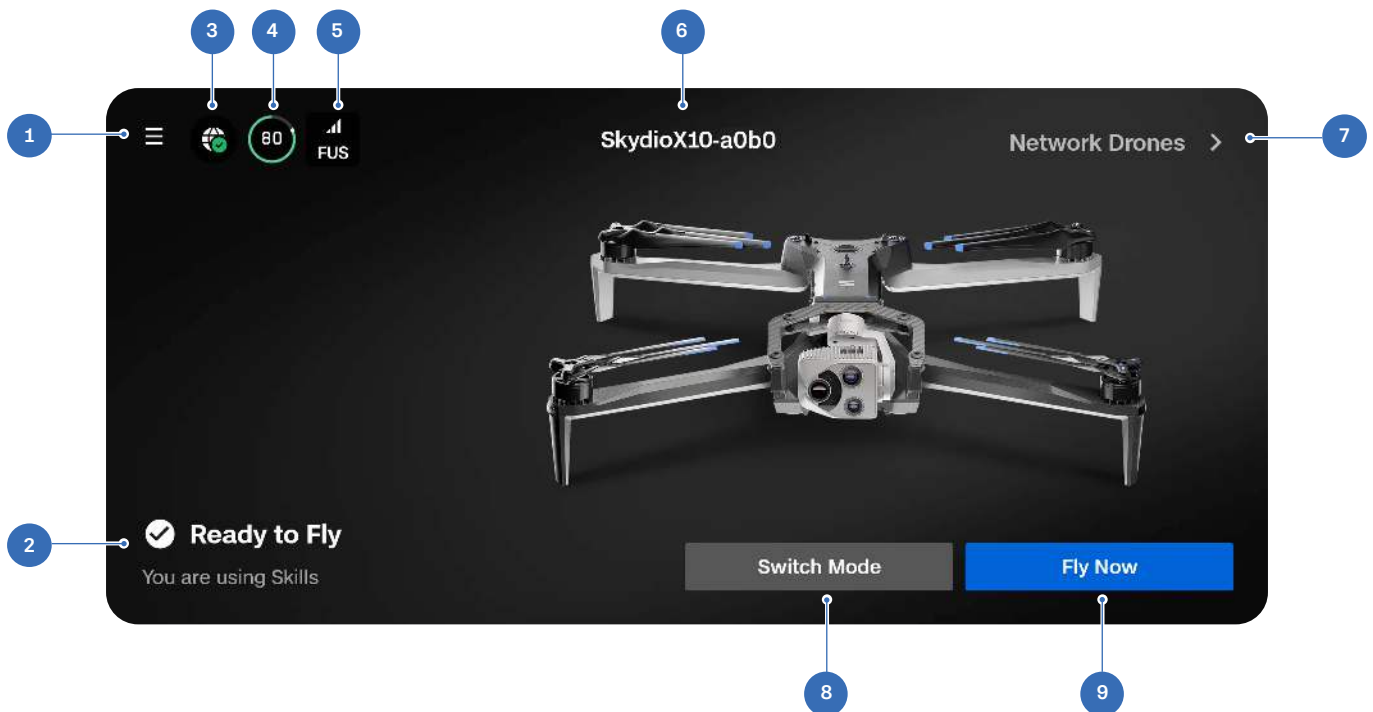

1. Global Settings
2. Flight Status
3. X10 Controller Network Status
4. Drone Battery
5. Signal Strength (select to use Connect Fusion, SL, or 5G)
6. Drone Name
7. Network Drones (displays active drones in your organization)
8. Flight Mode Selector (Skills or 3D Scan)
9. Fly Now (opens Flight Screen)



**INFO:** For more information about flying over cellular, visit [How to fly Skydio X10 over cellular connectivity](#).

# Global Settings

The Global Settings menu is accessible before and during flight. You will use this menu to navigate to a variety of settings, such as low battery behaviors, stream layouts, and obstacle avoidance behavior.

Select the Global Settings icon in the top left of the screen to access the following menu:

- Media
- Information
- Flight Controls
- Sensing
- Return
- Lighting
- Attachments\*
- Connection
- Radio
- Display
- System Status

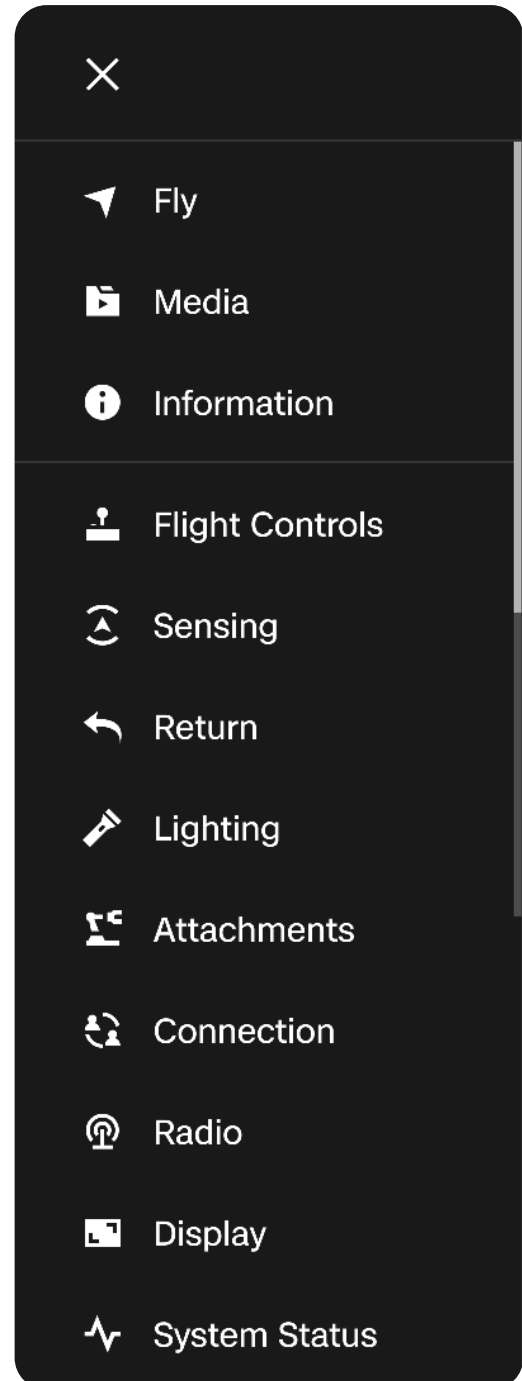

*\*Only appears if you are using an attachment*

# Media

Use this menu to view photos, videos, and scans from your recent flights.

- Select an image or video to view
- Press and hold on a thumbnail to select multiple or delete

If you capture photos using **Interval**, all photos captured will appear as a single stack. Selecting the stack will allow you to scroll through individual images one by one.

Only standard color and thermal JPGs will display in the Media menu. To access your DNG or RJPG files, you must transfer the files from your drone.



**NOTE:** Media is not accessible inflight.

# Information

While you are connected to Skydio X10, the Information menu provides access to settings such as drone and controller updates, radio frequency selections, the map library, and more.

## Devices

Lists the name of the drone that is currently connected, as well as other X10 drones that have previously paired to the controller.

Check for drone updates and verify software versions by selecting the name of a drone.

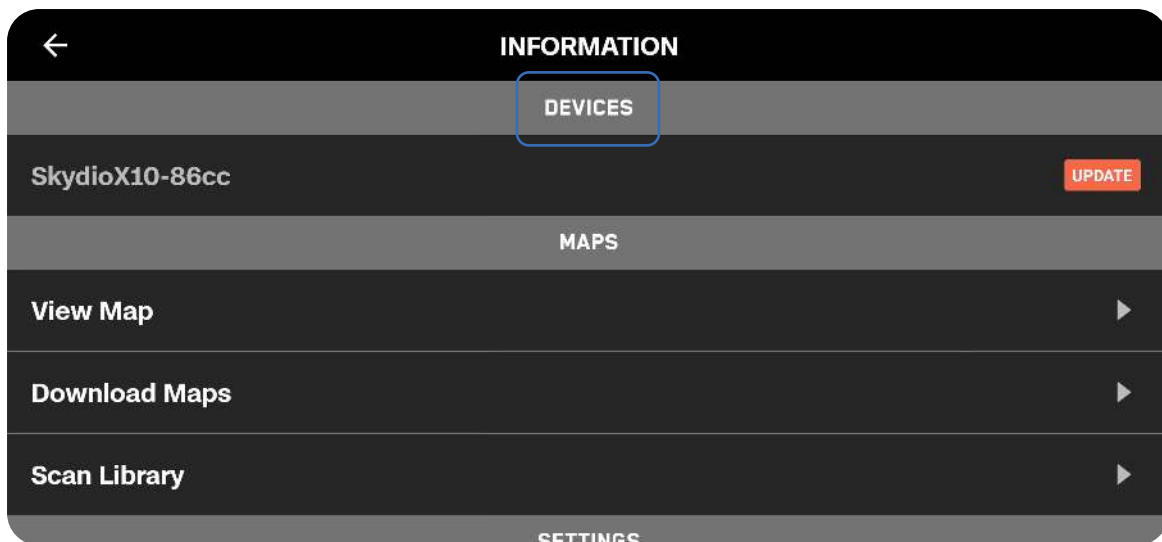

## Manage Data

Select to format the Log and Media cards or Factory Reset your drone.

## Locate Skydio X10

In the event that your Skydio X10 is lost, you may view its last known location. If the Coordinate setting is enabled, the latitude and longitude of the current or last known location will be displayed.

## View Last Flights

Displays the feed that was last viewed from the Flight Screen, even if the drone is not connected. Designed to assist you with locating your drone in the event of a crash, emergency landing, or low battery landing in an unintended location.

## Cloud Settings

Provides visibility into the licenses you have assigned to your drone, features, and the networks you have added in Skydio Cloud.

## Upload Files

Monitor the progress of file uploads from the X10 Controller to the Cloud, including flight telemetry.

## Overwrite Media

Manage your media storage by automatically deleting old media to ensure you always have enough storage space to start a new flight. Select Delete Oldest Media to automatically delete the oldest media stored on the microSD memory card.

## Anti-flicker

Adjust anti-flicker settings if you experience flickering in your video. This setting is for users located outside of North America, in countries where the frequency of the alternating current in household electrical outlets is 50 Hz.

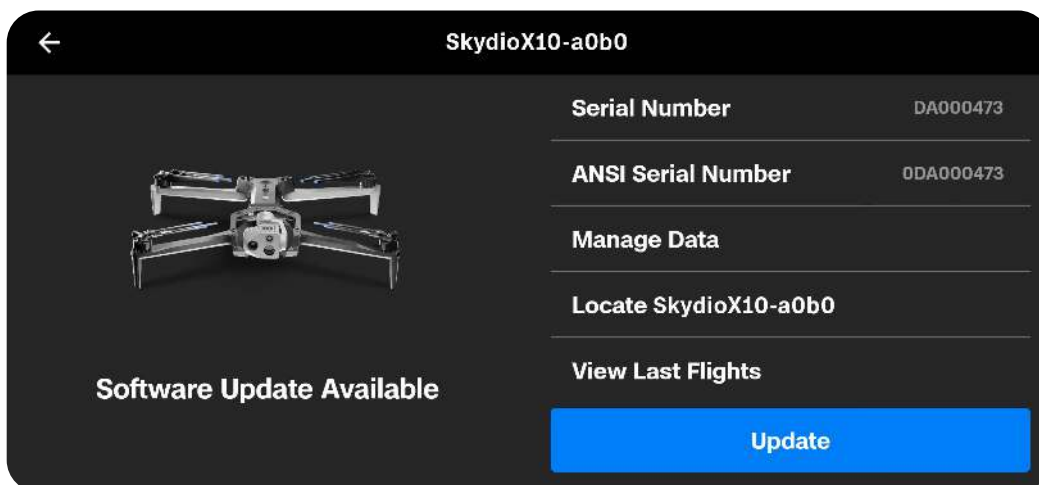

## Maps

### View Map

View your current location, search, and configure map settings.

The location of Skydio X10 (if connected), the controller, Launch Point, and Home Point (if set) are all indicated on the map. You will also be able to view alerts for nearby crewed aircraft via ADS-B alerts.



Skydio X10



Controller



Launch Point



Home Point

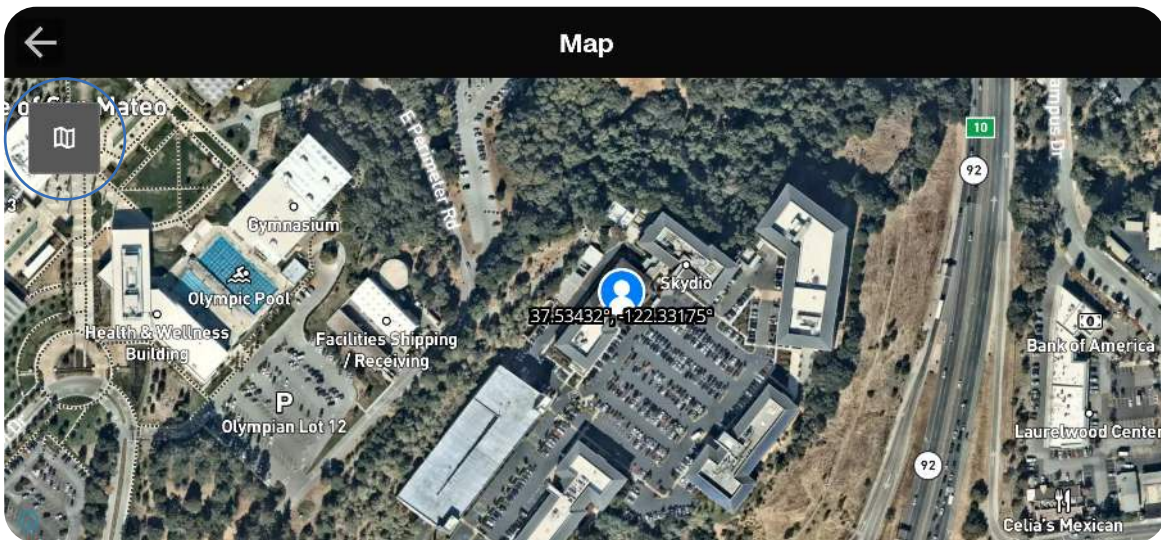
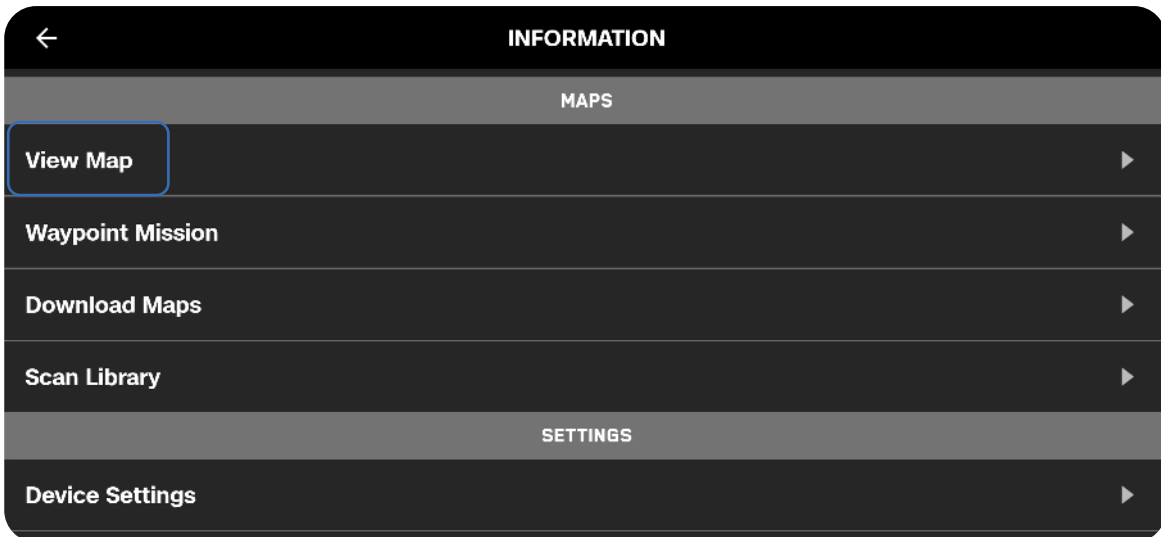

### Map Library

Three distinct galleries help you manage maps:

- **Imported** - Base maps added from a USB-C drive
- **Downloaded** - Base maps added using the Download Maps feature
- **Layers** - Map overlays added from a USB-C drive that always render above base maps

Base maps and layers are limited to 15 files to prevent excessive storage usage on the controller.

For more details on adding Map Layers or Downloading Maps, see the *Operations Planning* section.

## Waypoint Mission

Stores the most recent Waypoint Mission. Press and hold on a waypoint to delete it. Press and hold on the map to add a waypoint or delete all waypoints.

Only one Waypoint Mission will be saved at a time.

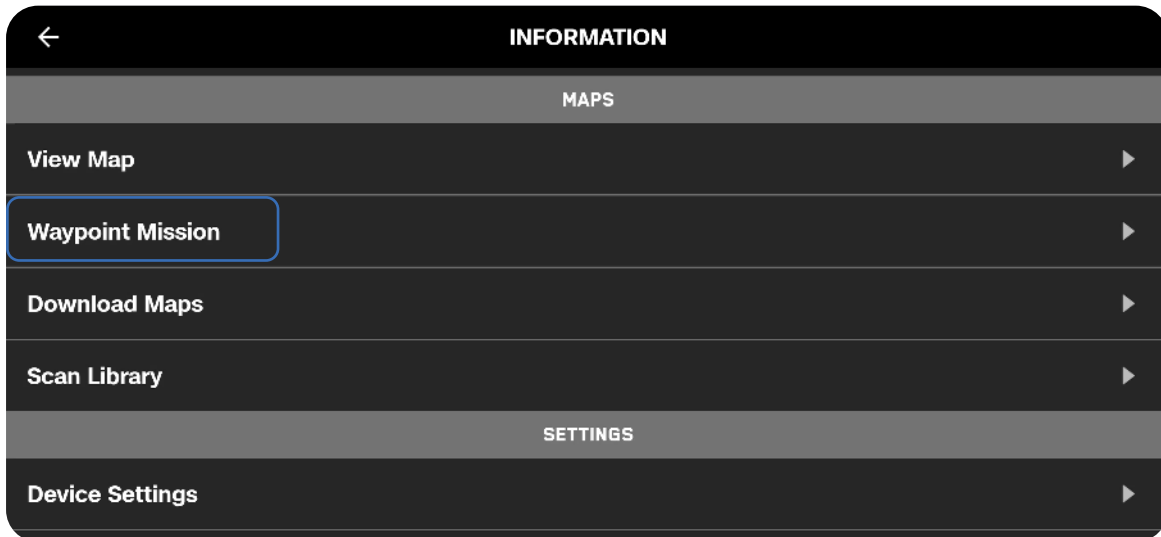

## Download Maps

- Select the blue + icon under Add New Maps and a satellite view of your current location will display.
- Drag and pinch-to-zoom on the map until your desired location is centered on the screen
- Use the search bar to enter coordinates or type a location
- Select Download Map to save

The map will be 3.5 x 3.5 square miles, centered around the target point even if you are zoomed in. Your map will appear in this menu once the download is complete.

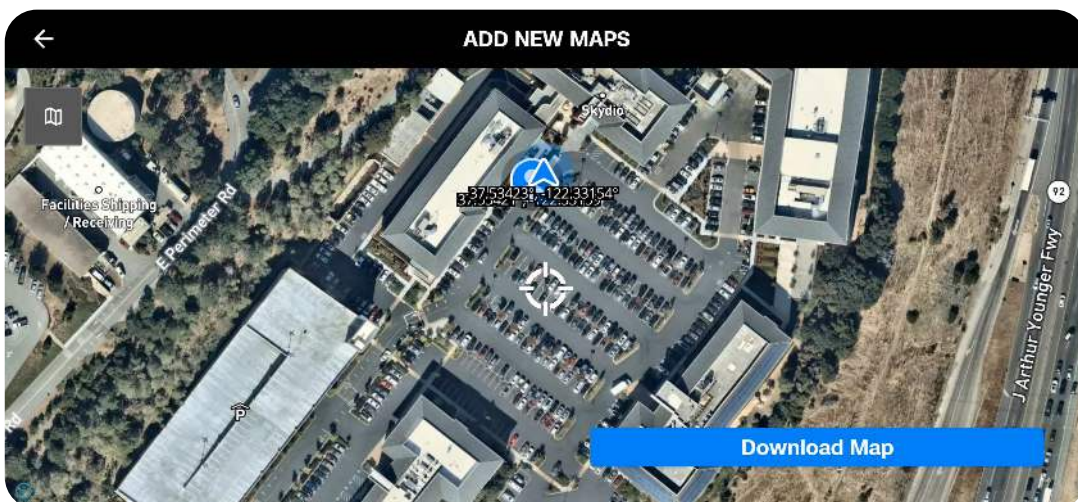
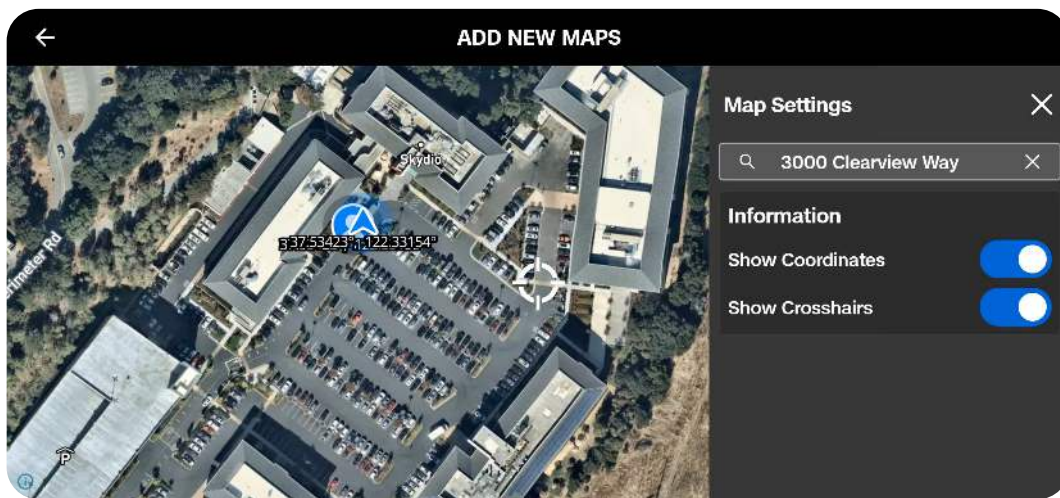

**NOTE:** Base maps and layers are limited to 15 files to prevent excessive storage usage on the controller.

## Scan Library

View or repeat saved Map Capture scans. You also have the ability to import a previous Map Capture.



**INFO:** For more information, visit [How to use Map Capture](#).

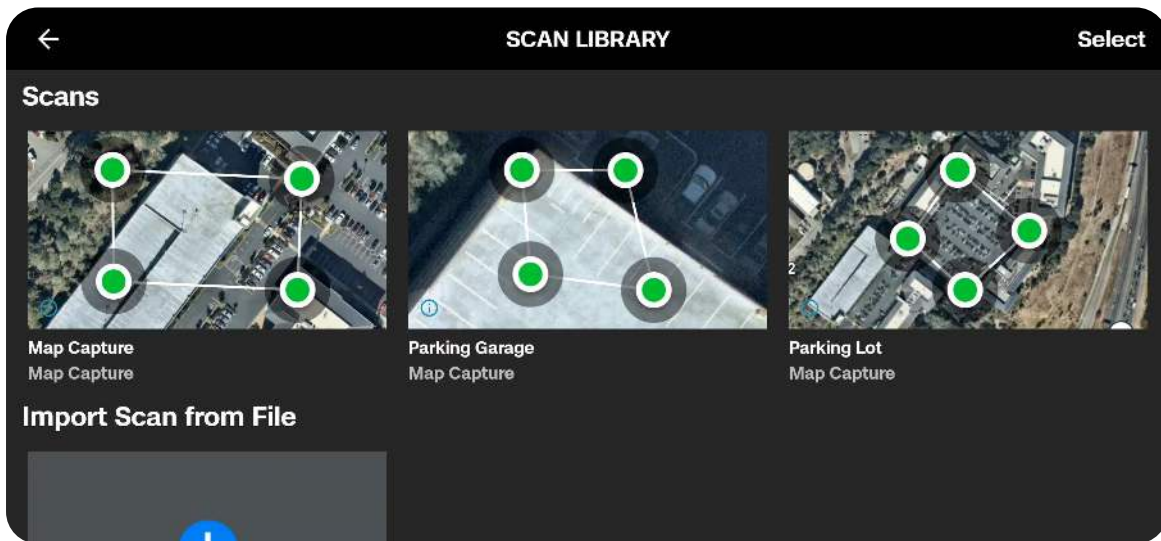

**NOTE:** Only *.mission* files created from Skydio Map Capture are supported when importing.

## Settings

### Controller Update

Use this menu to view the current software version of your controller and to check for or initiate updates.

### Create/Change Password

Optionally add a password for your controller.



**CAUTION:** *The password cannot be recovered or reset. Ensure that your password is entered correctly and is written down and stored in a safe location. If the password is lost, the controller will need to be replaced.*

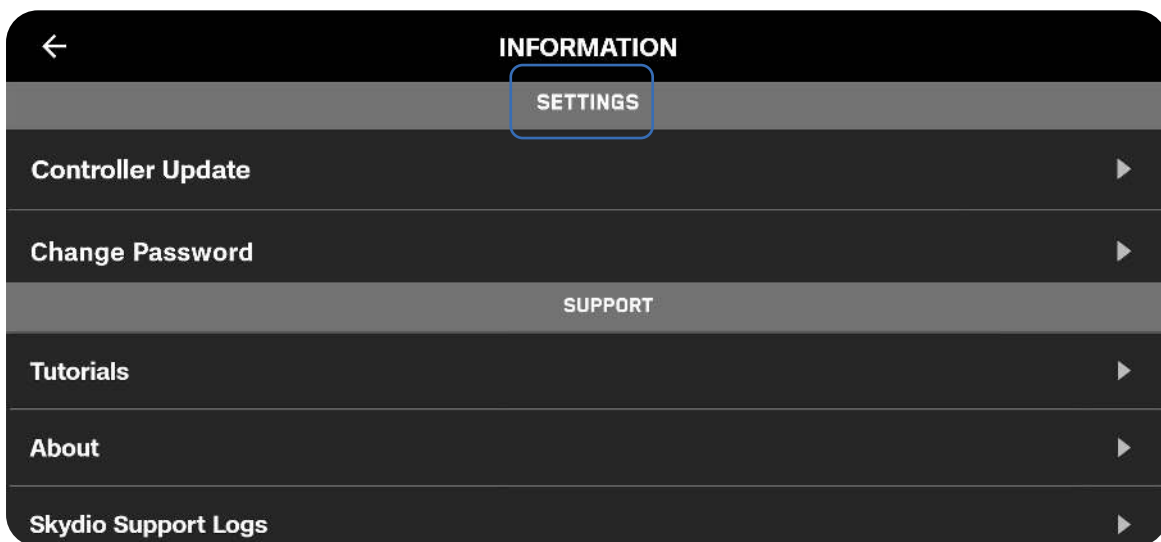

# Support

### Tutorials

Includes step-by-step instructions for actions such as calibration.

### Hand Wave Calibration Guide

For use in environments with magnetic interference such as cars, metal bars, power lines, etc. You will need to calibrate before flying at night without NightSense.

### About

View the current software version of the X10 Controller, the email associated with your account, and your organization.

### Skydio Support Logs

To assist the support team and better troubleshoot any issues or questions you may have, we may require you to upload logs or other data from your drone to help us determine the root cause of any issues. Refer to the Sending Support Logs section for step-by-step instructions on uploading logs.

If you have any objection to this, please let the support team know. We will never review your videos or data without your permission. Do not reformat or factory reset your Skydio drone prior to contacting our support team.

### Single Flight Log

Includes all logs from a specified flight. This option will show you the history of all flights, organized by date and time. Select which individual flight you wish to upload.

### All Logs

Exports all logs saved on the controller from all flight history. This option allows you to sync logs whether you are connected to the drone or not.

### Legal

View legal documentation such as the Skydio Safety and Operating Guide.

# Flight Controls

Use this menu to customize your joystick controls, input mapping, and altitude limits.



Moving the joysticks allows you to adjust the roll, pitch, yaw, and throttle of the drone.

**Roll** - Controls left and right movement

**Pitch** - Controls forward and backward movement

**Yaw** - Changes rotation around the vertical axis

**Throttle** - Controls altitude

## Sensitivity

### Gimbal Pitch

Controls how quickly the camera sensor package moves up and down.

- Default - 18%

### Flight

Allows you to customize the maximum allowed speed for roll, pitch, yaw, and throttle.

Default sensitivity:

- Roll - 35%
- Pitch - 35%
- Yaw - 45%
- Throttle - 100%

### Rapid Descent

Allows you to increase the speed to the maximum descent rate when pressing and holding Boost (L1 button).

- Descent speed: 27 mph (12 m/s)



**NOTE:** Increase pitch sensitivity to increase the maximum speed of the drone.

## Controls

### Battery

Displays Skydio X10 Controller battery level.

### Control Mode

Determines how your controller joysticks will maneuver X10. Select between Mode 1, 2 (default), and 3.

### Input Mapping

Allows you to customize buttons and wheels with the following options:

- Obstacle Avoidance (Close, Minimal, Disabled)
- Cycle Display Layout
- Cycle Thermal Palettes
- Cycle Full Screen View
- Reset Sensor Package
- Toggle Strobe Lights
- Toggle RGB Lights
- Stop at Structure
- Quick Yaw
- Quick Gimbal Pitch
- Exposure Compensation (+/-)
- No Function

Customizable buttons include: C1, C2, C3, L2, R2.

You can also invert your wheel directions, assign Exposure Compensation to your Right Wheel (instead of Zoom), or assign No Function to your wheels.

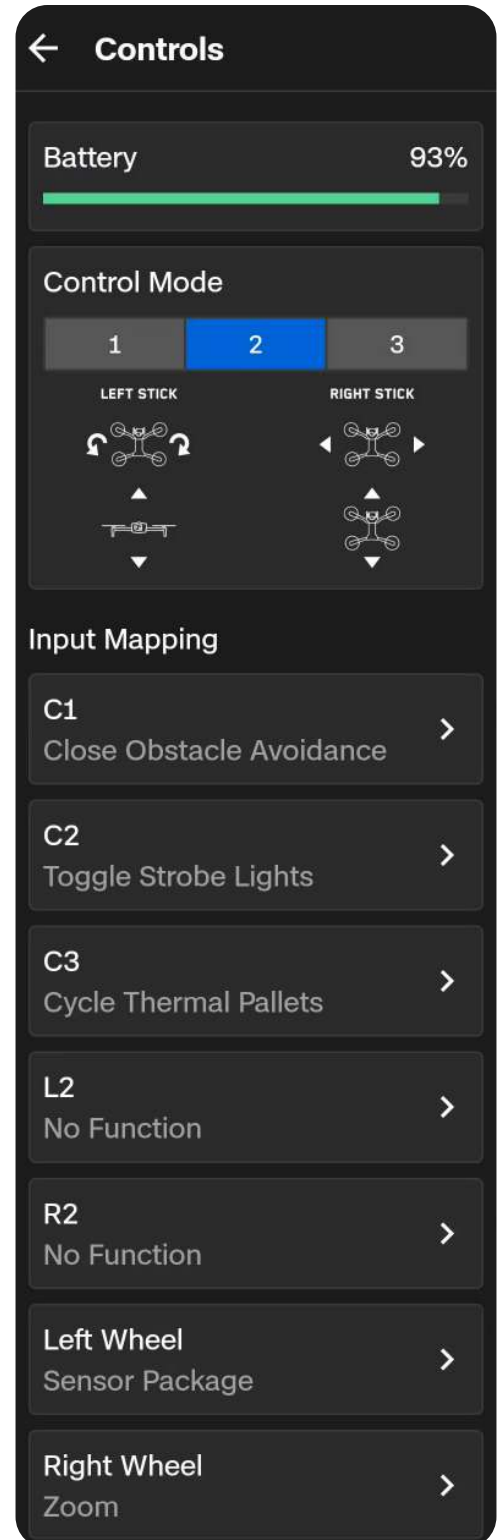

### Quick Shot: Quick Yaw and Quick Gimbal Pitch

**Quick Gimbal Pitch** and **Quick Yaw** shortcuts help Pilots reposition the camera and drone more quickly during inspection workflows. Make large, repeatable pitch and yaw adjustments with a single action, reducing the need for manual fine-tuning when capturing consistent views.

These features reduce the time pilots spend using fine adjustments with the gimbal wheel or manual yaw adjustments, enabling faster, more consistent inspection imagery.

Select the **Global Settings Menu > Flight Controls > Controls > Input Mapping**.

- Incrementally move the gimbal through preset angles (-90°, -45°, 0°, 45°, 90°) with dedicated buttons for up/down.
- Each button press adjusts pitch or yaw by a set angle increment; repeated presses continue stepping in the same direction.
- **TIP:** Assign opposite pitch or yaw increments to two buttons to quickly toggle between repeatable angles.



**NOTE:** *Quick Pitch and Yaw is available in Manual Flight only and does not apply to Flight Skills, including Subject Track and Waypoints.*

### Action Wheel

Assign functions to your controller D-pad and quickly preview and select functions in flight.

Once functions are assigned, hold the Back button on the controller to bring up the Action Wheel menu. While holding the Back button, press the D-pad up, left, or right to execute that function.

### Camera Dragging

Drag your finger on the screen to pitch the sensor package and yaw the drone to look around.

### Joystick/Roller Input

Enabled by default. This toggle functions as a safety precaution in the event that you experience a hardware issue with the joysticks.

When disabled, you will still have the ability to use touchscreen inputs and buttons on the controller.

**Only disable this toggle if you experience errors with the joystick controls.**

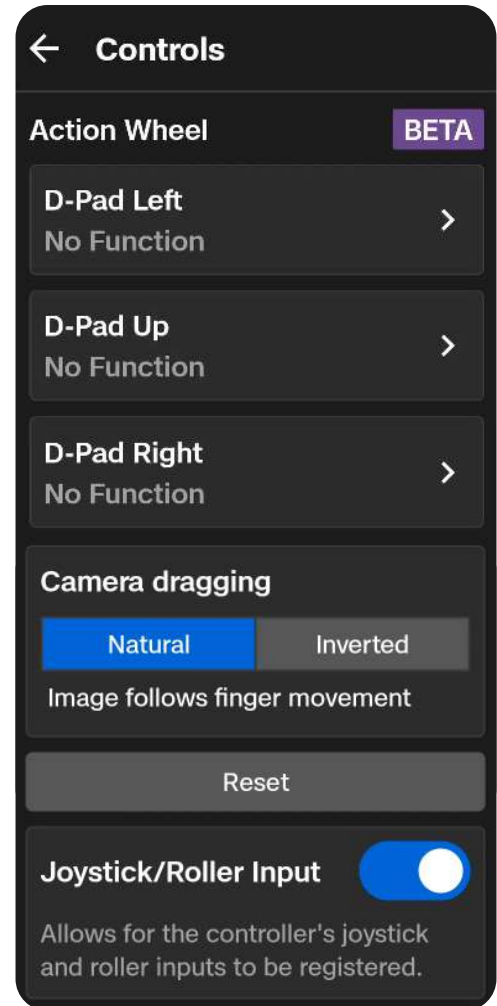

**WARNING:** Disabling the Joystick/Roller Input toggle turns off joystick functionality, which may result in serious bodily injury and/or damage. You may only disable this toggle if you experience errors with the joystick controls and proceed with extreme caution. Any injury and/or damage resulting from disabling this toggle is not covered under Skydio's Limited Warranty.

## Control Mode

By default, flight controls are set to Mode 2.

In Mode 2, the left joystick controls the elevation and horizontal rotation of the drone, and the right joystick controls the forward, backward, and lateral movements of the drone.

### Left Stick

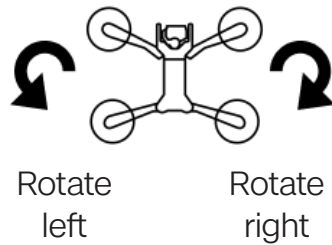
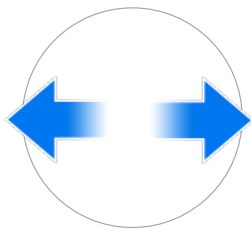
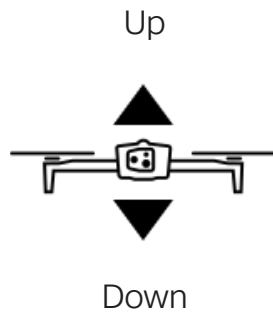
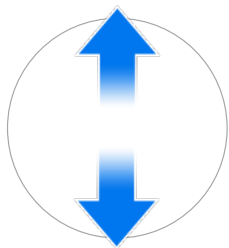

### Right Stick

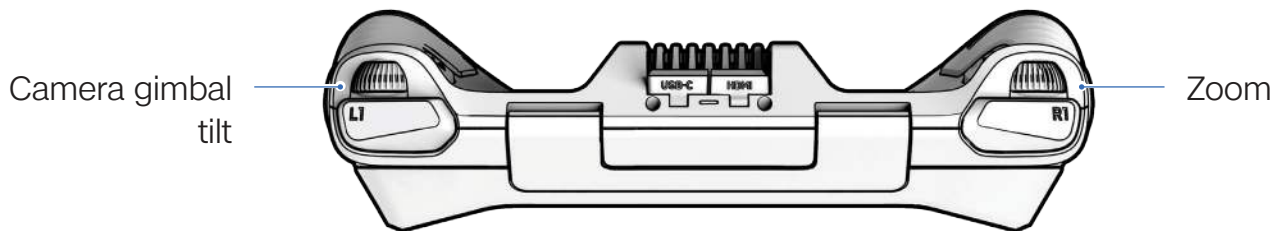
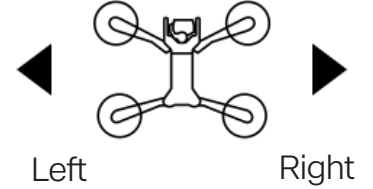
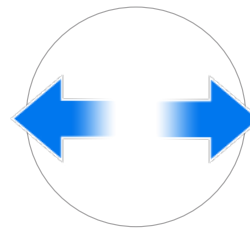
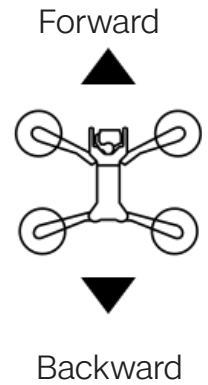
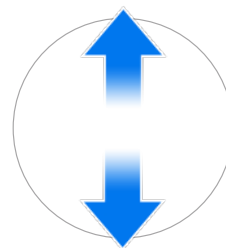

## Limits

### Height Ceiling

When enabled, allows you to set the maximum allowed drone altitude above the Launch Point.

- Minimum: 30 ft (9 m)
- Maximum: 1500 ft (457 m)

Height Ceiling settings persist across flights and power cycles.

### Weak GPS Alt Limit

When enabled, prevents flight above 164 ft (50 m) when GPS is weak.

If GPS is lost, Skydio X10 maintains continuous navigation using Visual Navigation (VIO), which operates alongside GPS and can fully take over all navigation functions.

The drone can maintain stable VIO at altitudes up to 984 ft (300 m).

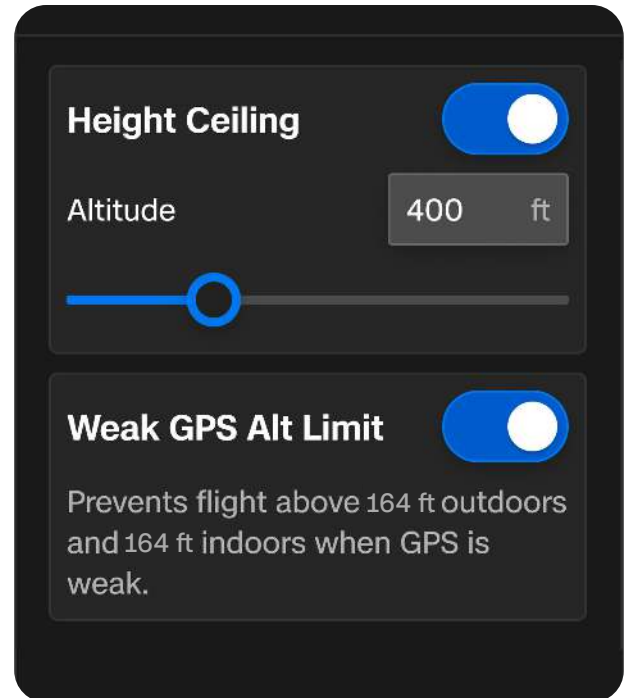

**WARNING:** Toggling Weak GPS Alt Limit OFF disables the altitude limit and your drone will fly using only visual navigation. To reduce the risk of an emergency landing, maintain a flight path near surfaces and objects.



**NOTE:** If you are using the NightSense attachment, the Weak GPS Alt Limit is 16 ft (5 m).

# Sensing

Use this menu to adjust autonomous flight behaviors.

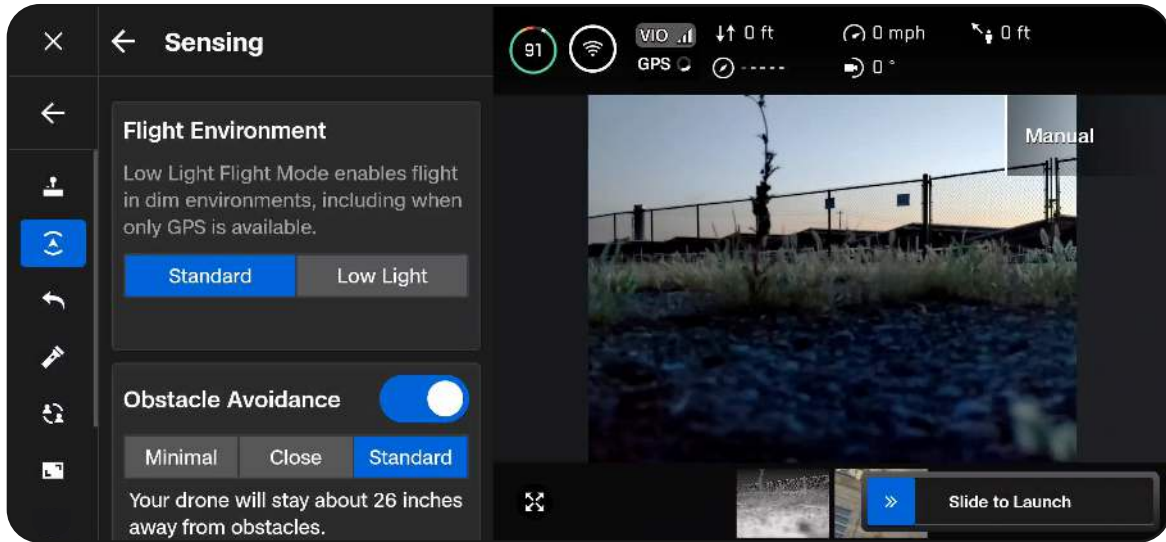

### Flight Environment

Select either Standard or Low Light to best represent your flight environment

**Standard (default)** - flight in normal daytime or in brightly lit conditions (i.e. indoors)

**Low Light** - flight at night or in low-light conditions with poor visibility.

### Obstacle Avoidance

When flying near obstacles your drone will follow your selected distance setting. Choose between Standard, Close, and Minimal.

**Standard (default)** - Drone stays 24 in (60 cm) away from obstacles (15 in, 39 cm in narrow spaces)

- Top ground speed: ~36 mph (16 m/s)

**Close** - Drone stays 6 in (15 cm) away from obstacles (5 in, 13 cm in narrow spaces)

- Top ground speed: ~18 mph (8 m/s)

**Minimal** - Slight course corrections to avoid obstacles, but primarily relies on the pilot to avoid collisions.

- Top ground speed: ~18 mph (8 m/s)

**Disabled (toggle off)** - Skydio X10 will not avoid obstacles and there is a high risk of collision

- Top ground speed: ~45 mph (20 m/s)

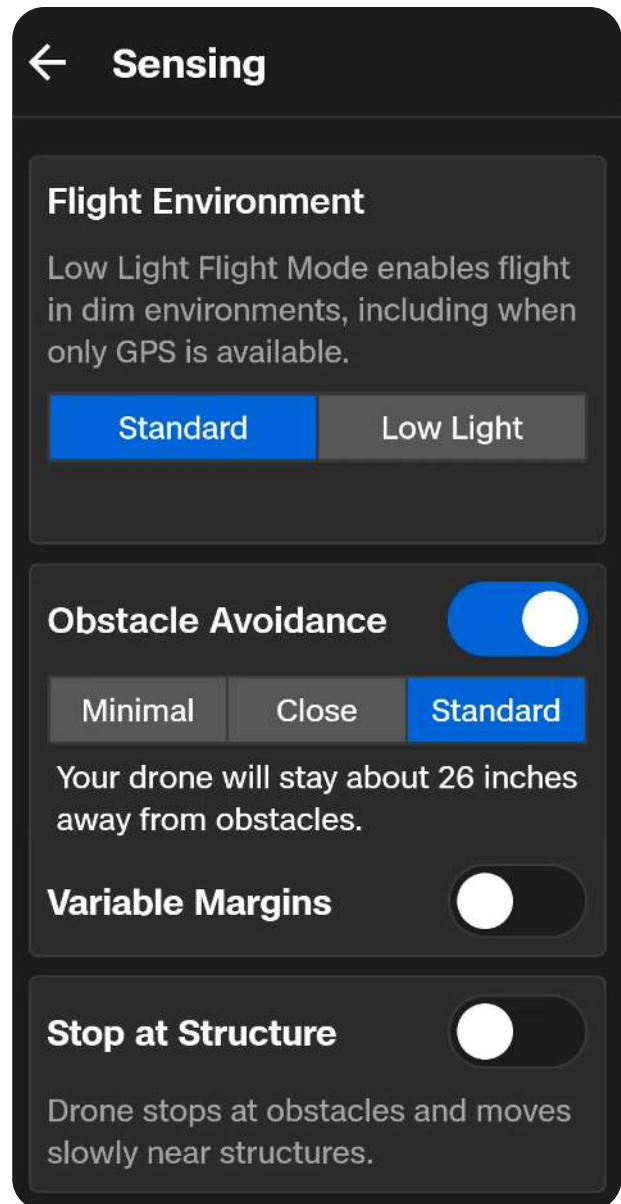

### Variable Margins

Skydio X10 uses AI and visual navigation to dynamically, and temporarily, reduce obstacle avoidance margins when moving through narrow spaces. Margins will also dynamically expand if the drone detects environmental dangers, such as wind.

Enabled by default. Disable to turn off the dynamic margin behavior.

### Stop at Structure

Perform finer, more controlled inspections on structures such as bridges or building facades.

When enabled, your drone will not deviate from its course when it is within 8 ft (2.5 m) of a structure.

The drone will reduce speed and maintain position, allowing for more precise maneuvering in the immediate vicinity of the structure.

- Adjust the maximum speed using the Speed Near Obstacles slider
- Maximum controller speed settings apply when no structure is present
- Stop at Structure is active during manual flight, including when paused during a 3D Scan



**CAUTION:** *Flying with Close, Minimal or Disabled settings greatly increases the risk of collision. Minimal or Disabled settings are used to navigate tight spaces and should only be used if you are an experienced pilot. Skydio recommends turning down controller throttle, roll, and pitch sensitivity to the lowest setting and proceeding at a maximum speed of 2 mph (1 m/s).*

## Return

Configure your standard return behaviors as well as how Skydio X10 will return if connection is lost.

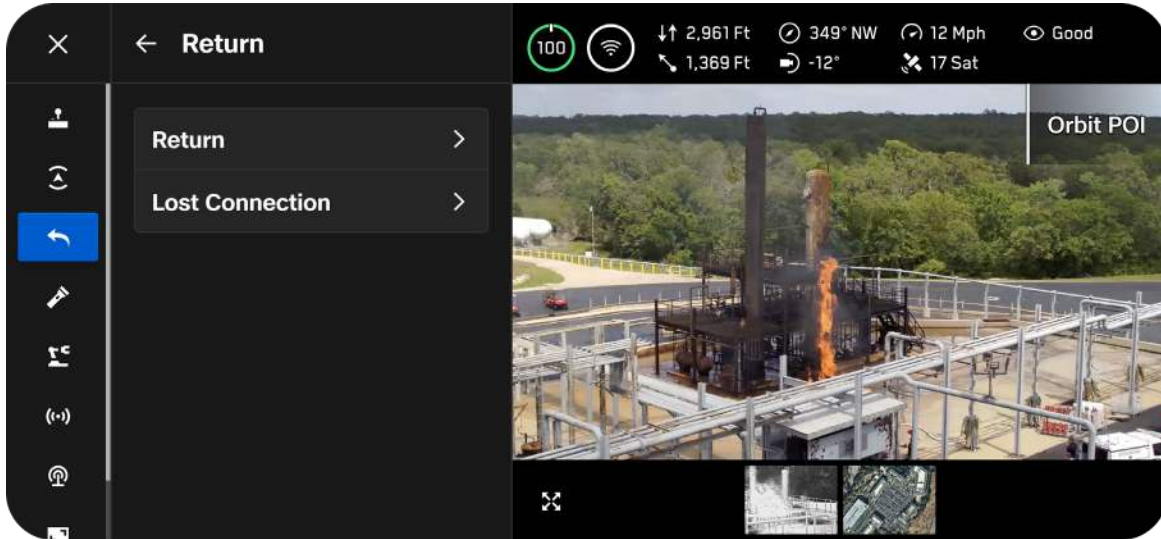

**WARNING:** Before flying, ensure you have set your Lost Connection Return Behaviors. This is a critical step that ensures your drone returns safely and lands in an accessible location.

## Return

### Height Behavior

Customize the altitude behavior of Skydio X10 when returning.

Use Return Height to set the altitude at which the drone will ascend to before returning.

**Absolute** means your drone will ascend to the specified Return Height above the Launch Point before returning

- For example, if the Return Height is 32 ft and the drone is at 20 ft at the time the return is commanded, Skydio will ascend 12 ft before returning

**Relative** means your drone will ascend to the specified Return Height above the current position before returning

- For example, if the Return Height is 32 ft and the drone is at 20 ft at the time the return is commanded, Skydio will ascend 32 ft and then return at a height of 52 ft

### Drone Will Face

Set Skydio X10 to either look toward or away from the return destination while flying.

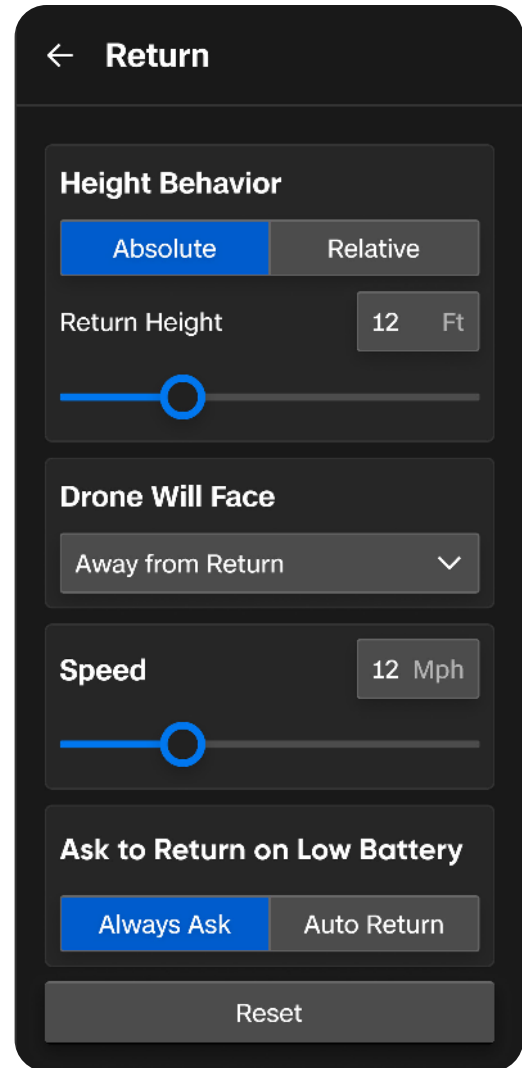

### Speed

Set the speed at which Skydio X10 returns.

- Vision return: 1 - 35 mph (0.5 - 16 m/s)
- GPS return: 1 - 45 mph (0.5 - 20 m/s)

### Ask to Return on Low Battery

When the battery is only sufficient to return and land, choose between a prompt or an automatic return.

- **Always Ask (default)** - you will be asked to select the return location each time the battery level is low
- **Auto Return** - the drone will automatically return to either the Launch Point or the Home Point (if set) when the battery is low (default in Remote Flight Deck)

# Lost Connection

If connection is lost, Skydio X10 will default to the **Lost Connection** settings. Select between **Return** and **Hover** upon lost connection.

## Return

**Wait Before Return** - set the amount of time you want Skydio X10 to wait before it initiates a return flight, allowing time to reconnect

**Land After Return** - when enabled, your drone will return, hover for a specified amount of time, then land.

**Wait Before Land** - the amount of time between 0 to 300 seconds (default is 240 seconds) that you want your drone to wait above the landing location before landing. This setting is only enabled when Land After Return is toggled on.

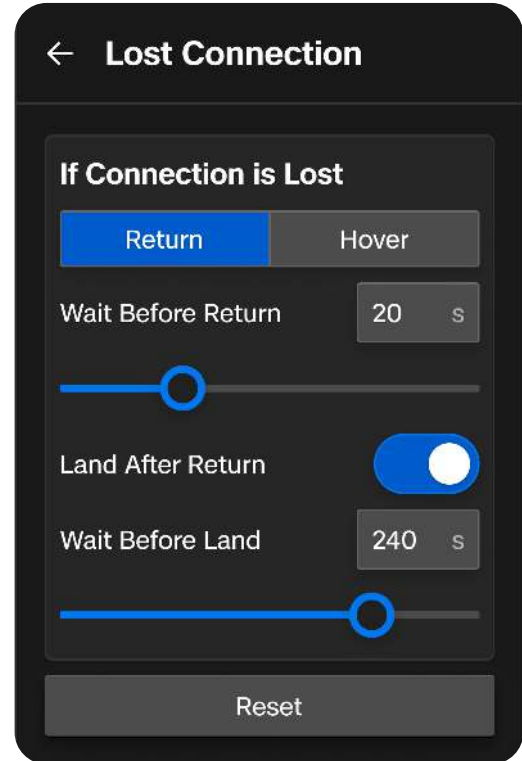

### Hover

**Land After Hover** - when enabled, Skydio X10 will hover for a specified amount of time, then use visual navigation to find a safe area to land.

**Wait Before Land** - the amount of time between 0 to 300 seconds (default is 240 seconds) that you want your drone to wait before landing. This setting is only enabled when Land After Hover is toggled on.

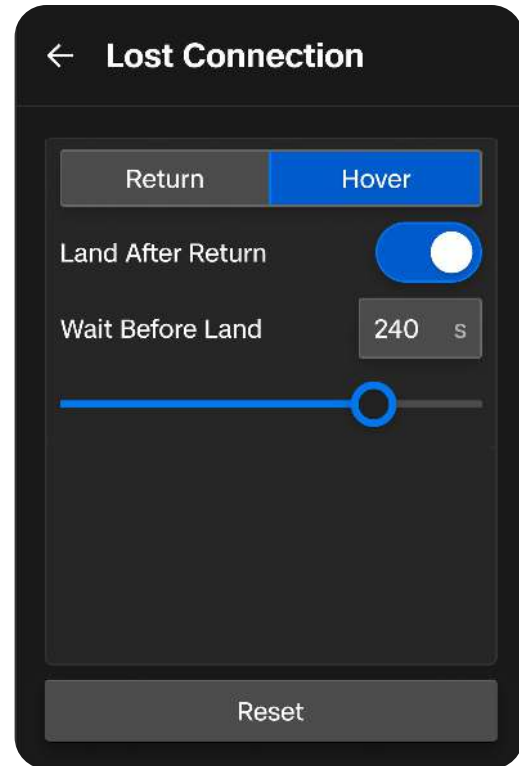

Skydio X10 will continue hovering as it tries to regain connection. If it fails to reconnect and reaches low battery:

- If you have an automatic return set, your drone will return to either the Launch Point or Home Point (if set)
- If you do not have an automatic return set, your drone will use visual navigation to find a safe area to land
- If VIO is degraded (flying in Low Light without NightSense), your drone will be unable to use visual navigation and will descend vertically and land

# Lighting

Customize the inflight behavior of the RGB/strobe lights that are located at the end of the arms.

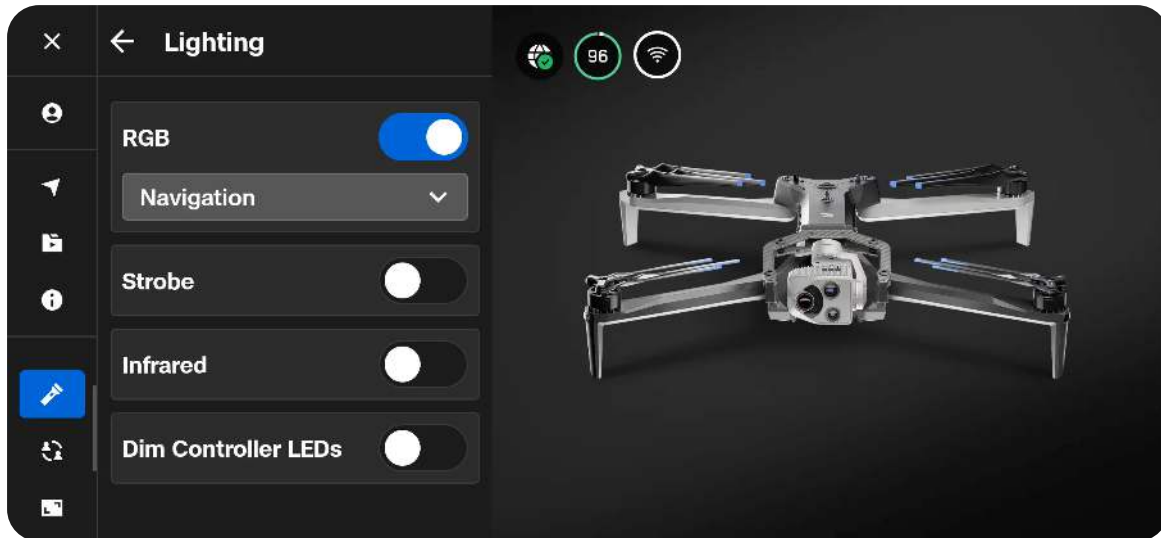

### RGB

Choose between Navigation, Police, or Emergency lights.

- **Navigation (default)** - When enabled, the lights on the end of the arms will appear red and green while flying. When the drone is powered on and grounded, the lights will appear blue.
- **Police** - When enabled, the front and back RGB lights will flash red and blue and alternate colors between the right and left arms.
- **Emergency** - When enabled, the front and back RGB lights will flash red and white and alternate colors between the right and left arms.

### Strobe

Enable to visually track the drone in low-light conditions. Skydio X10 strobe lights meet the FAA requirement of being visible at a distance of 3 statute miles (4.8 km).

### Infrared

Cannot be seen by the naked eye. These broadcast an IR light that can only be detected with an infrared lens. Assists with navigation in low-light.



**CAUTION:** *Police and Emergency lights option is only for strict use by authorized users comprising public safety first responders and emergency personnel performing a public safety mission.*

# Sharing



Use this menu to share a live stream of your flight or configure an ATAK or RTSP stream.

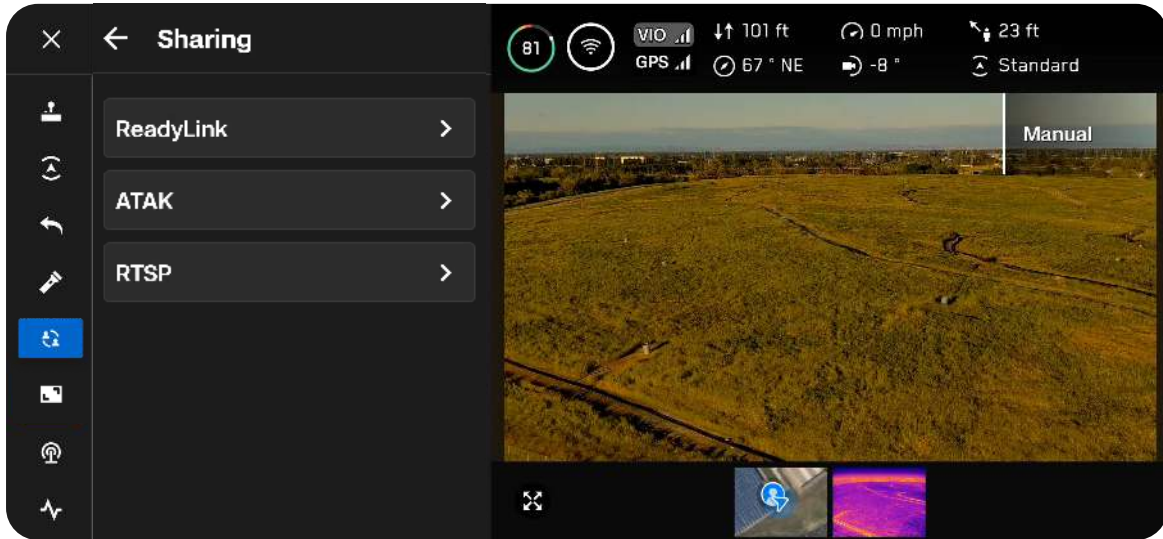

# Sharing a Live Stream with ReadyLink

ReadyLink allows you to share a live stream of your flight with others via a QR Code.

- **Connect SL** - You will see the ReadyLink option appear in the Sharing menu **after launching**
- **Connect Fusion or Connect 5G** - A ReadyLink will automatically generate after launching

Use the **ReadyLink Quick Action** in the Flight Screen to access the QR Code at any time.



**NOTE:** Skydio Live Streaming is an optional software add-on available for purchase. You must have Live Streaming to use ReadyLink. When flying over Connect 5G or Fusion, Skydio X10 will live stream automatically.

### Step 1 - Launch and open the ReadyLink menu

Navigate to **Global Settings > Sharing > ReadyLink**

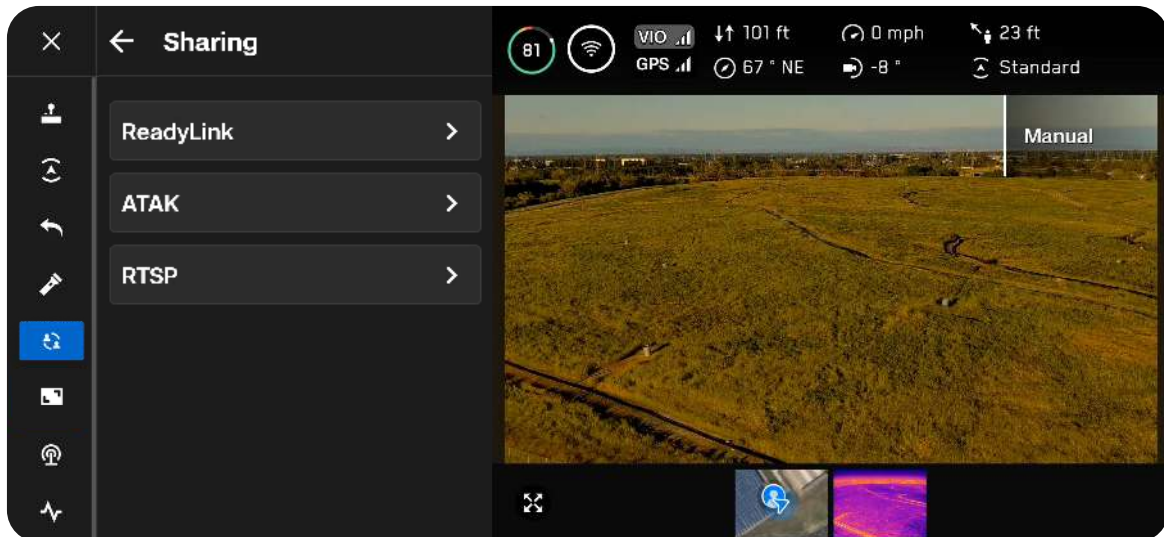

# Inflight Operations | Navigating Skydio Flight Deck

## Step 2 - Select Start ReadyLink

Wait a moment as the QR Code is generated.

Select the QR Code to share your stream. While streaming, you will be able to see how many viewers are watching your flight.

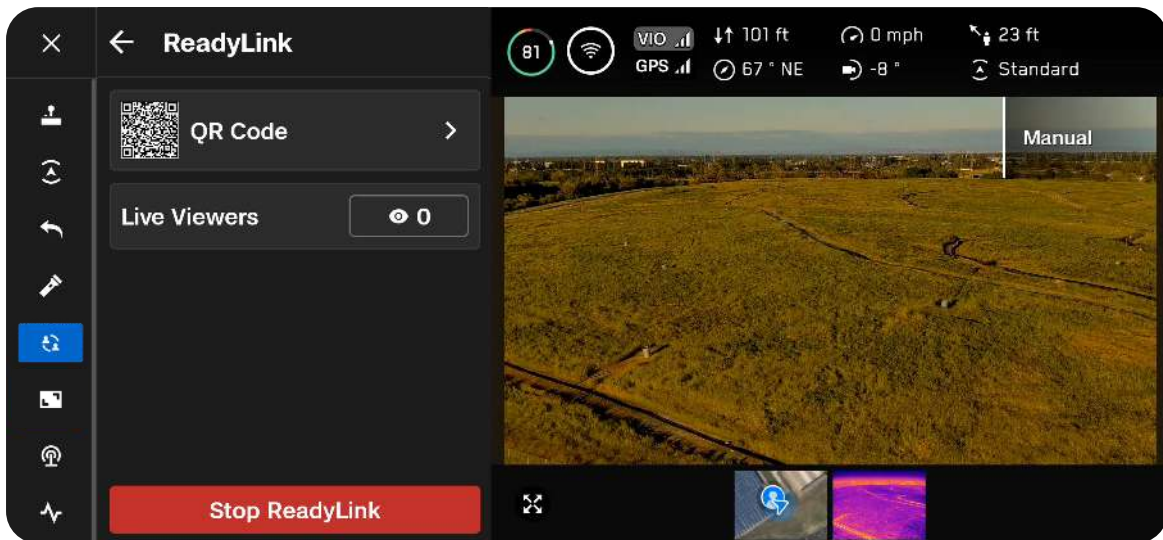
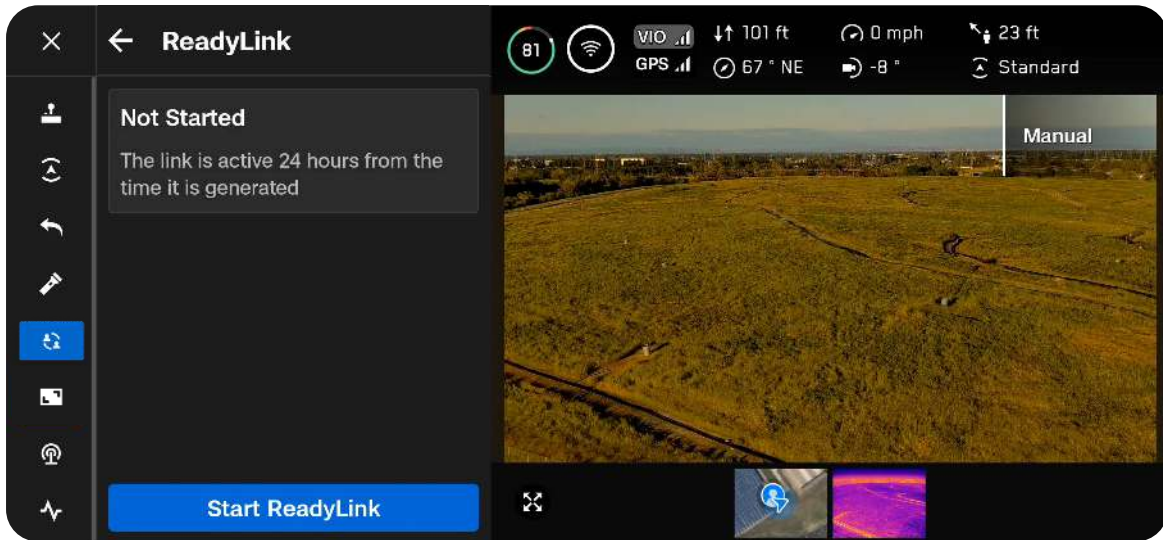

# Inflight Operations | Navigating Skydio Flight Deck

Use the ReadyLink Quick Action in the Flight Screen to access the QR Code at any time.



The controller will display ReadyLinks associated with your drone, including PIN codes when applicable. Active ReadyLinks appear based on your Skydio Cloud permissions, with the default ReadyLink shown first.

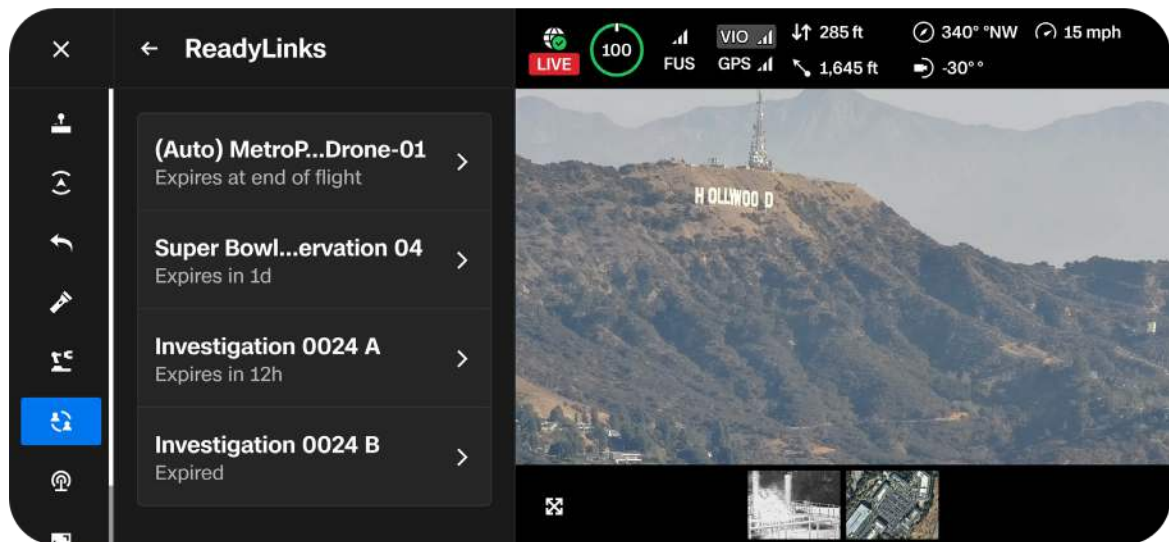

### ATAK

The integration of the Skydio X10 Controller and the Android Team Awareness Kit (ATAK) app allows you to seamlessly monitor your Skydio fleet. ATAK provides geospatial information about your drones and controllers for increased situational awareness in the field.

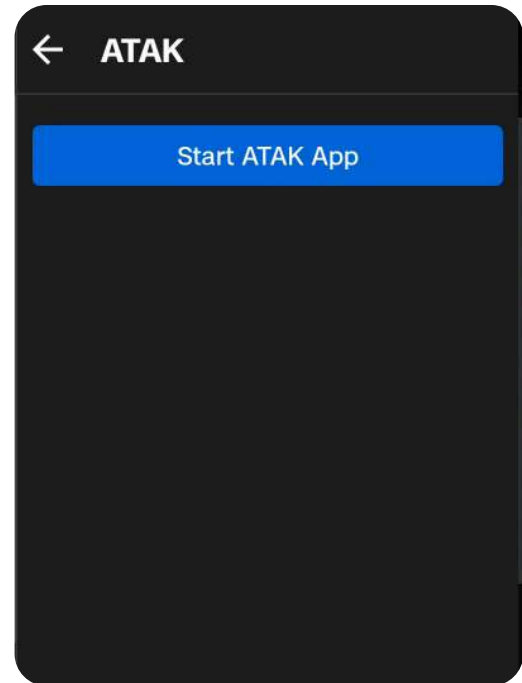

**INFO:** For more information about setting up ATAK, visit [How to set up ATAK with the Skydio X10 Controller](#).

### RTSP (Real-Time Streaming Protocol)

RTSP enables live video streaming from your Skydio drone directly to any compatible media player or system. This protocol allows for flexible, real-time monitoring of video feeds, whether you are using it for surveillance, situational awareness, or integrating with third-party systems.

## DroneSense Integration: Missions and Call Signs

Skydio's integration with DroneSense allows pilots to link flights to active missions directly from the Skydio Controller. This streamlines mission tracking and removes the need for the DroneSense CoPilot app.

If your organization has DroneSense enabled, a DroneSense option will appear under **Global Settings > Sharing** on the controller. From there, pilots can select or update an active mission either before launch or mid-flight.

Assigning a mission ensures that each flight is properly categorized in DroneSense, improving mission documentation and real-time awareness across your team. This is especially useful for DFR operations, training sessions, or incident-based response, where mission coordination and call sign accuracy are critical.



**NOTE:** This integration must be enabled by an Organization Admin in Skydio Cloud before it will appear on the controller. For more information, visit the [Integrations section of our Support Site](#).

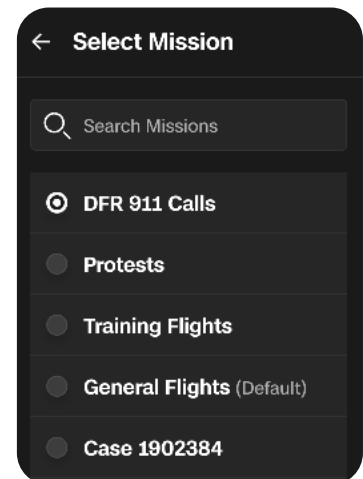
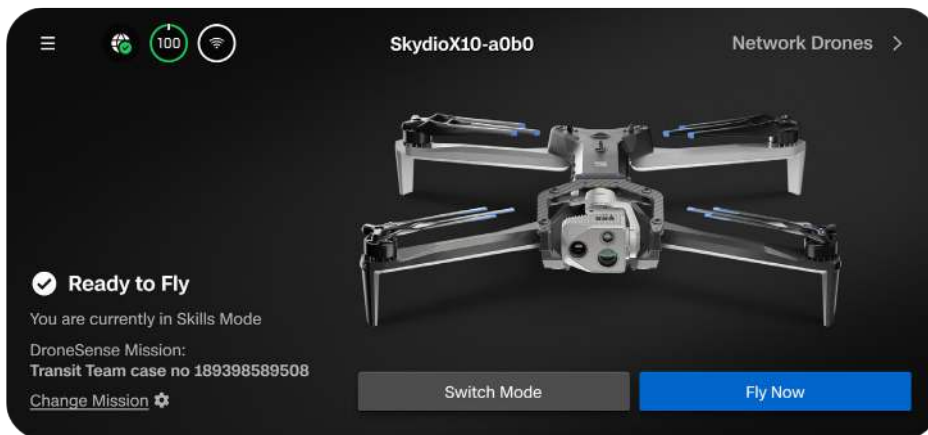

# Display

Customize your Flight Screen display, including telemetry metrics, unit type, and depth style.

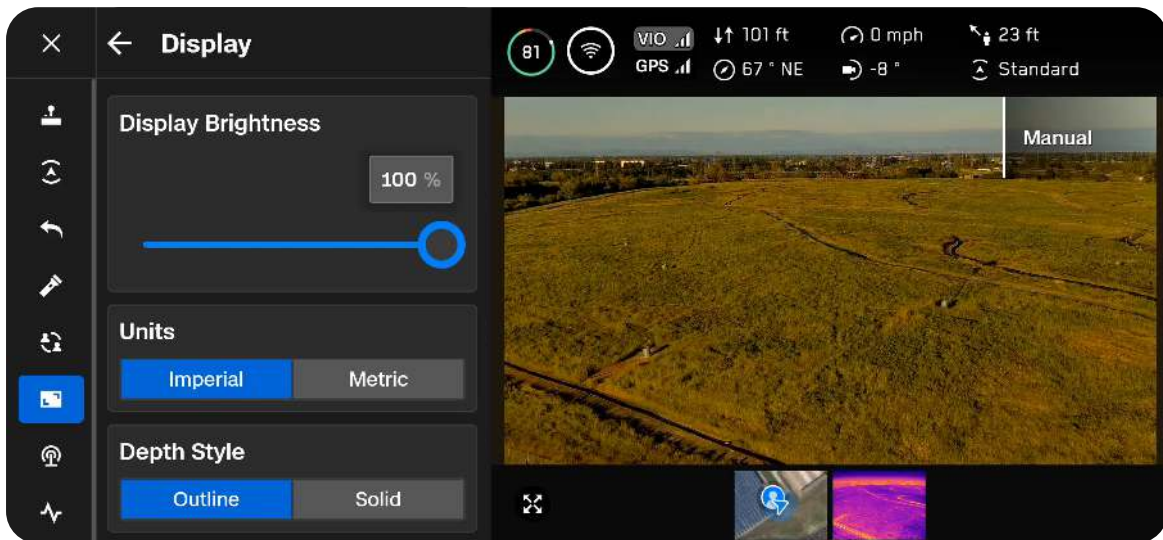
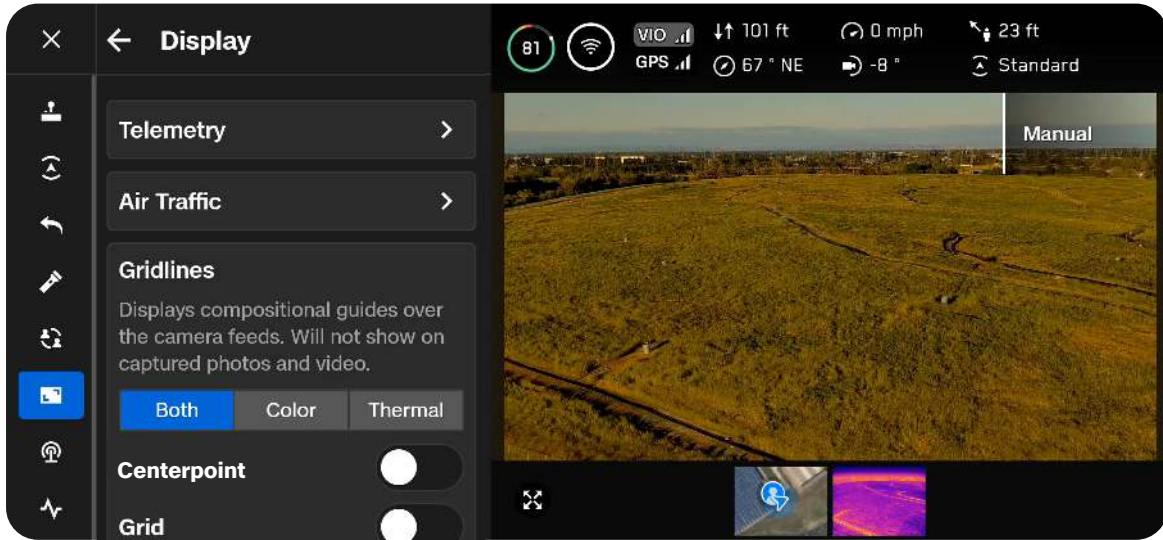

## Telemetry

Customize the telemetry metrics you want to display while flying. Select the blue checkmark to enable or disable the corresponding telemetry information. Up to 6 telemetry metrics may be displayed while flying.

Altitude is required.

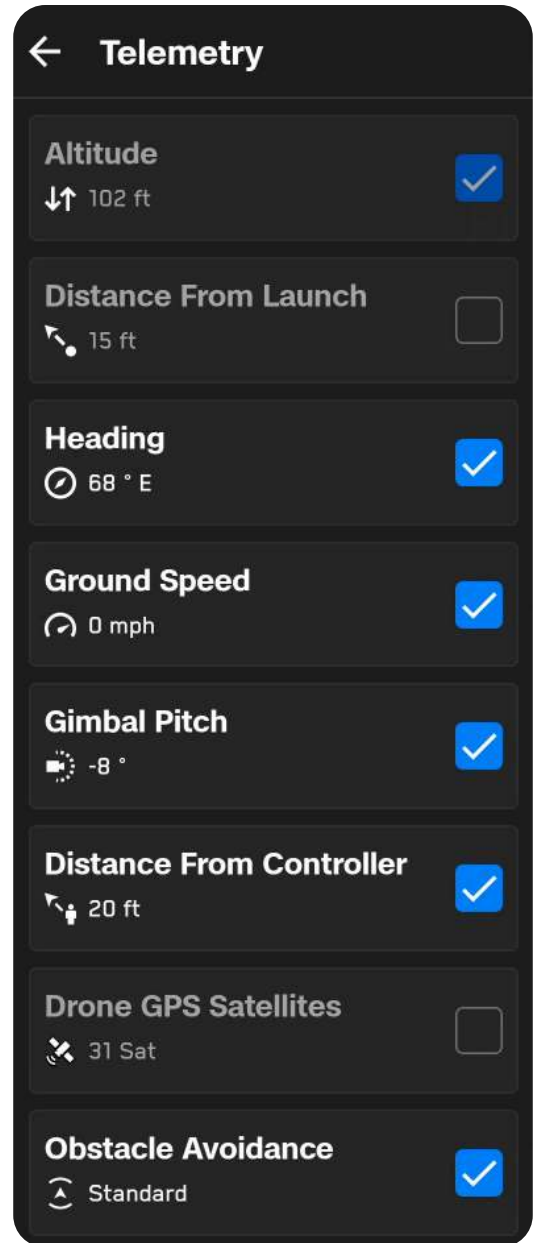

## Air Traffic

Use this menu to configure ADS-B settings for the inflight map.

**ADS-B Alert Range** - Use the adjustable alerting range to customize the detection sensitivity, where **V** is the vertical distance from the drone before the alert is triggered, and **H** is the horizontal distance.

When an aircraft enters your alert range, its icon will turn red and you will hear an audible alert through the controller speakers.

The default range is set to **Small**.

- Small - H: 0.5 NM; V: +/- 500 ft (152 m)
- Medium - H: 1 NM; V: +/- 500 ft (152 m)
- Large - H: 1.5 NM; V: +/- 500 ft (152 m)

**ADS-B Exclusion Range** - Provides information about the distance at which aircraft are removed from the map.

Aircraft are excluded:

- Outside 6.0 NM
- Above 3,000 ft (914 m)

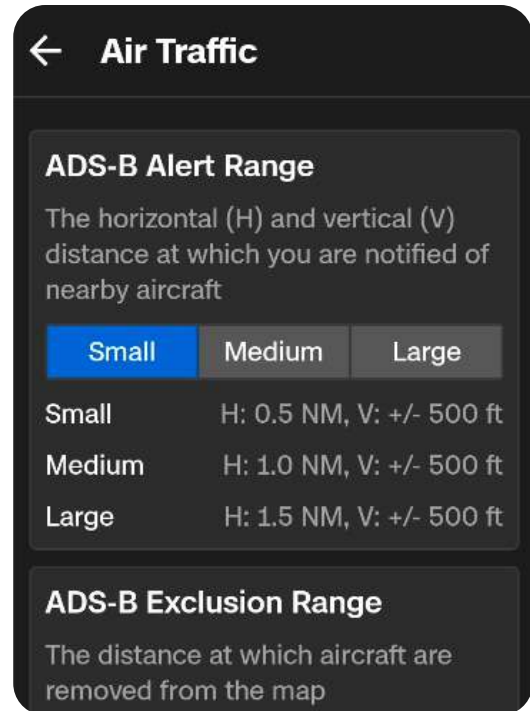

## Gridlines

Choose from **Centerpoint**, **Grid**, or **Diagonal** to enable on-screen framing guides. Assists with centering and framing subjects.

Each tool adjusts for day and night visibility. Available in **Photo** and **Video** modes for both color and thermal cameras.

Use the toggles to enable one, two, or all three overlays. When enabled, they display on-screen only, without appearing in captured media.

- **Centerpoint** - Displays a crosshair in the center of the screen to align subjects
- **Gridlines** - Adds a rule of thirds overlay for balanced framing
- **Diagonals** - Displays two intersecting diagonal lines from opposite corners, aiding in angular alignment

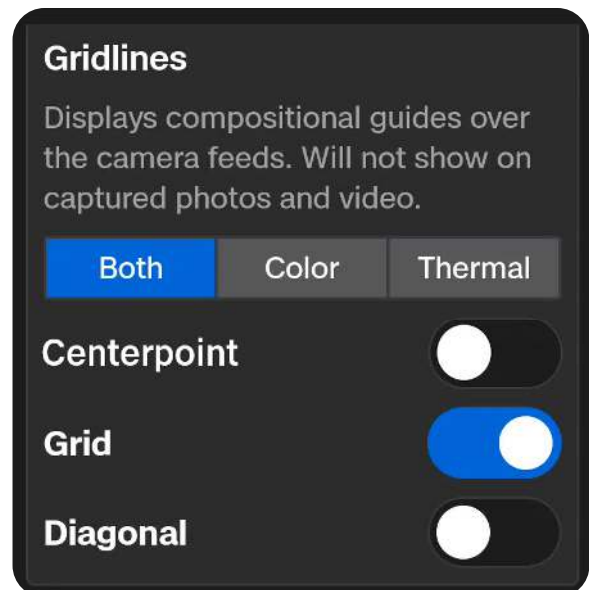
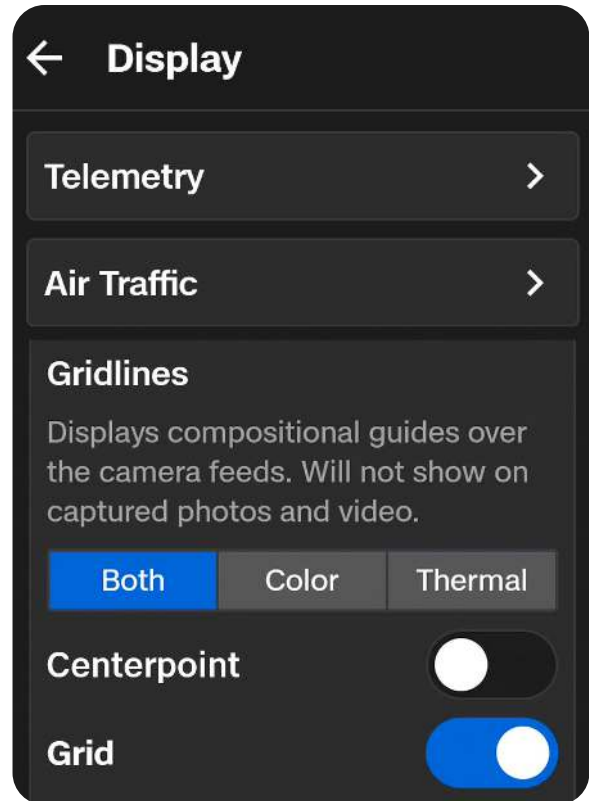

# Inflight Operations | Navigating Skydio Flight Deck



*Centerpoint*



*Grid*

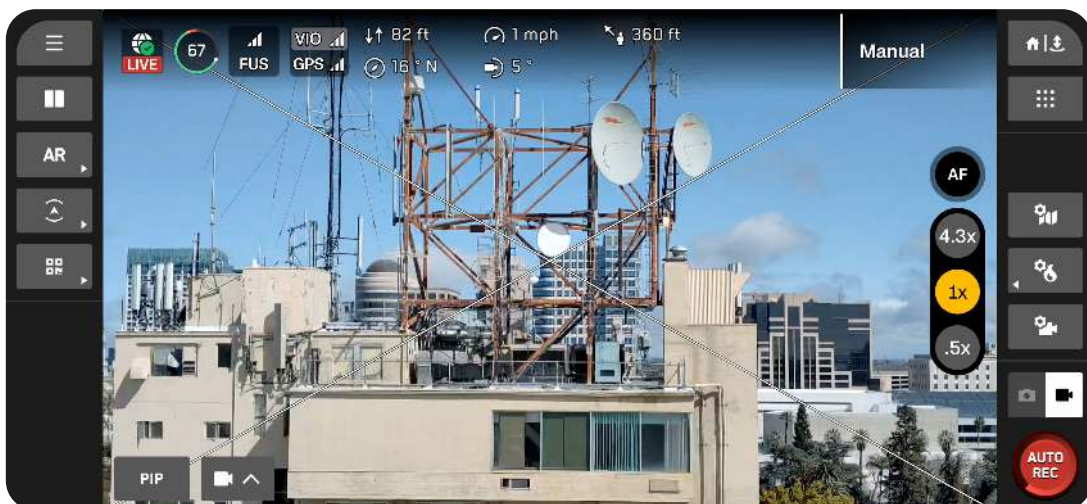

*Diagonal*

## Display Brightness

Adjust the brightness of your X10 Controller screen.

## Units

Choose between Imperial or Metric units.

## Depth Style

Only applies if you have enabled Depth View within the AR Quick Actions (located on the left side of the Flight Screen).

Select **Solid** or **Outline** when displaying visual information about what obstacles the drone sees.

- Solid displays boxes filled with color
- Outline displays wireframed or unfilled boxes

The **AR Quick Actions** button on the Flight Screen cycles between the distances from objects at which the visual information will start showing on screen.

- Off
- 6 ft (2 m)
- 13 ft (4 m)

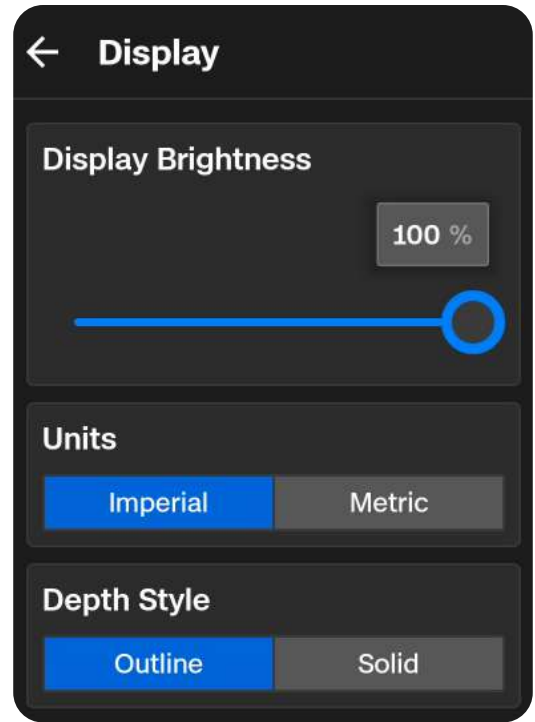

## Display Layouts

While flying, you have the option to use a Single, Split or Grid layout to set the number of streams that appear while flying. Available feeds include:

- Color
- Thermal
- Map

### Single Layout

Displays one stream at a time.

In this layout, you will see a Picture-in-Picture (PiP) in the bottom left of the screen.

- Minimize using the two arrows in the top right
- Use the buttons on the bottom to select whether the Color, Thermal or Map feed displays in the PiP

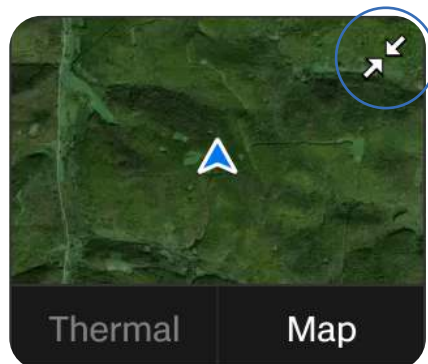
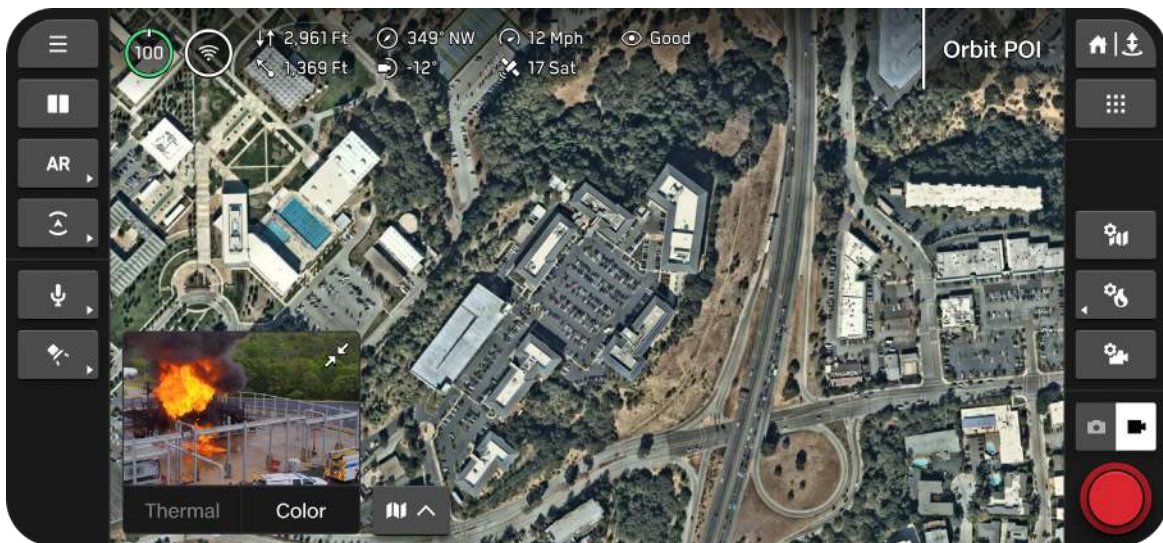

# Inflight Operations | Navigating Skydio Flight Deck

## Split Layout

Choose two streams to display. Drag the middle handlebar to resize streams.

The primary feed displays on the right.

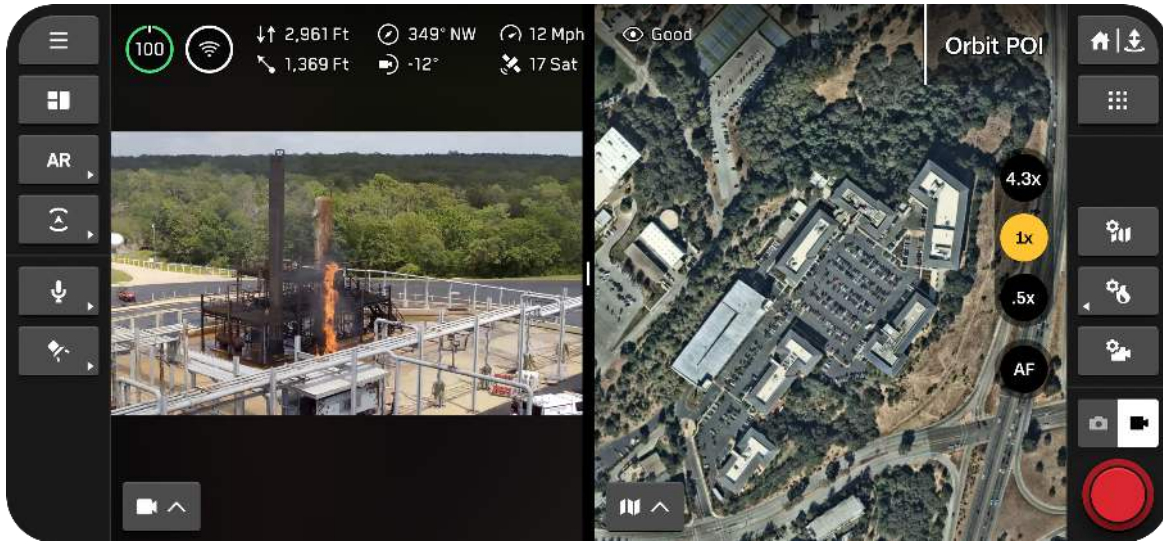

## Grid Layout

Choose three streams to display. Press and drag the middle handlebar to resize streams.

The primary feed displays on the right.



## Customizing Display Layout

### Step 1 - Select the Display Layout icon in the left sidebar

Use this button to cycle through the various layout options. The icon reflects the next layout in the queue rather than the layout you are currently using.



Single Layout



Split Layout



Grid Layout

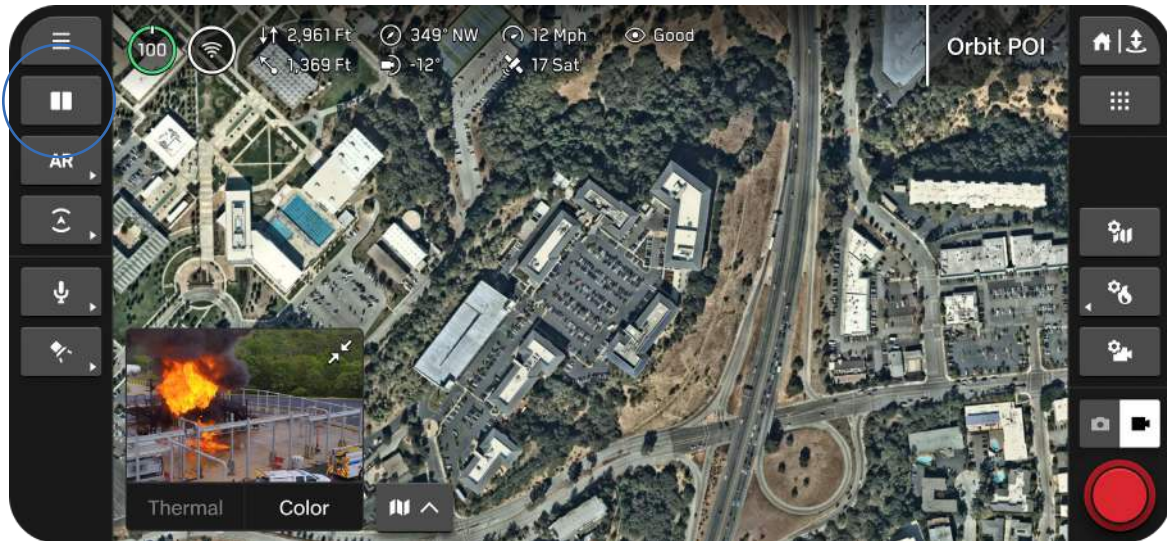

# Inflight Operations | Navigating Skydio Flight Deck

## Step 2 - Use the View Selector to select which feeds display

A menu will appear with the stream options. Drag the middle handlebar to resize streams.

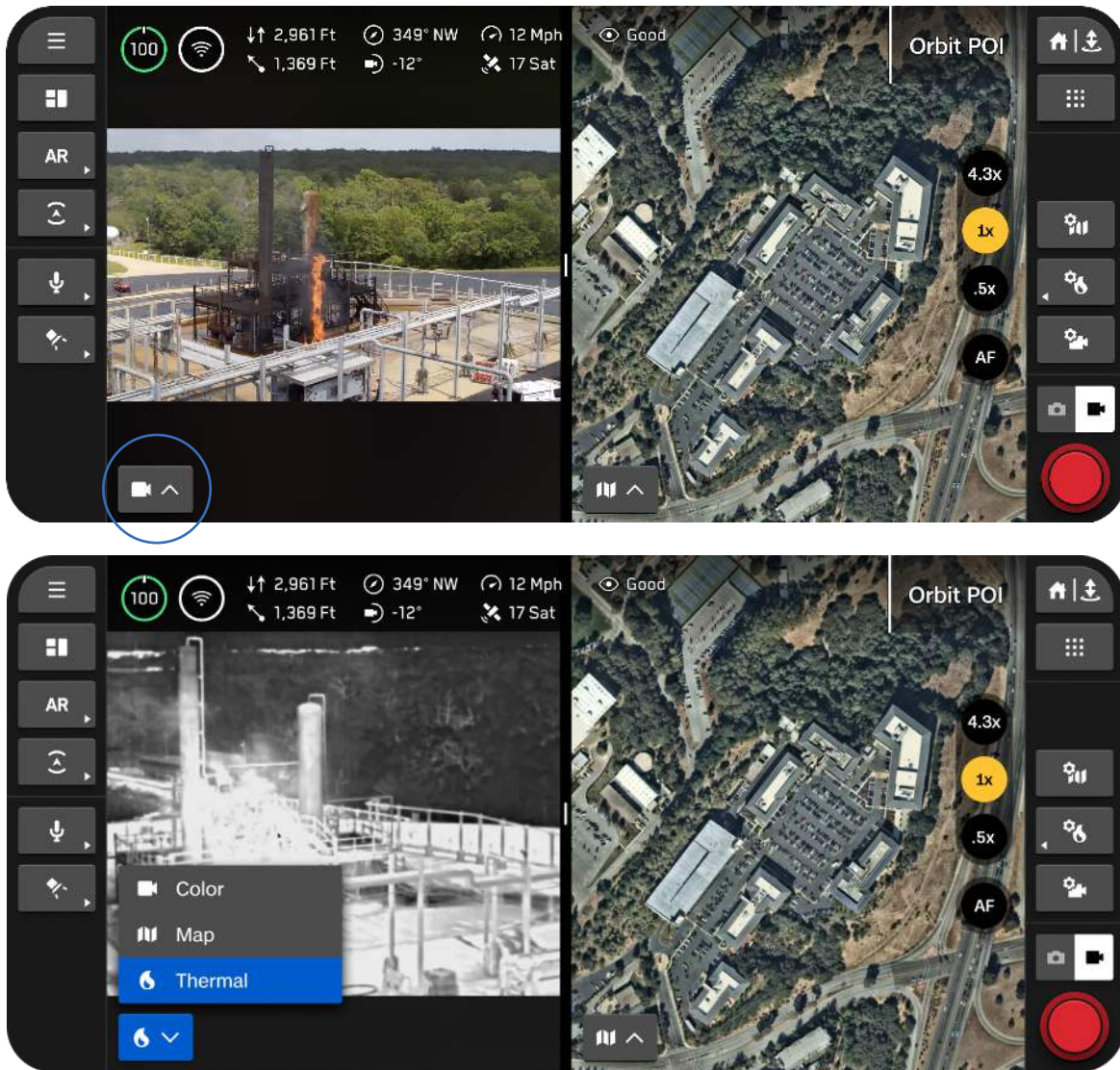

# Radio

Use this menu to configure your radio settings.

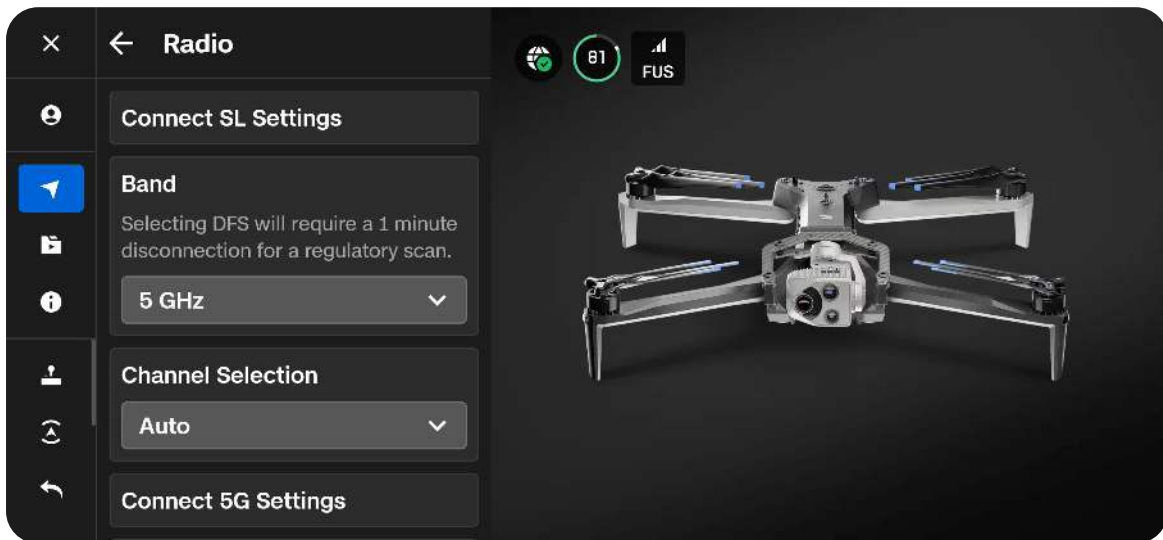
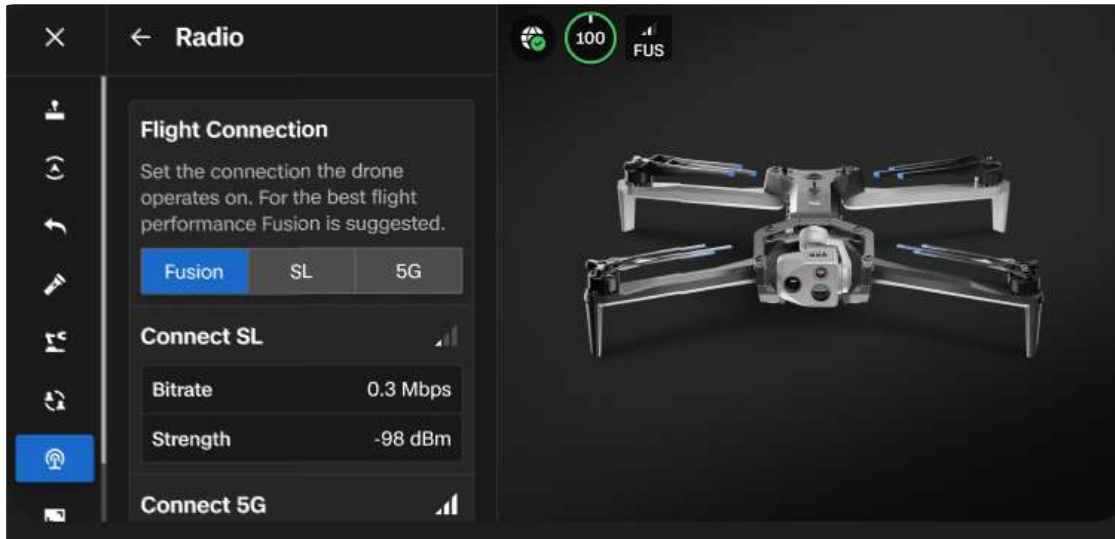

## Flight Connection

Set the connection X10 operates on. Displays the current link quality between the drone and controller, including signal strength (in dBm) and bitrate.

- **Fusion (default)** - Optimizes inflight connectivity by automatically selecting the strongest signal between Connect SL and Connect 5G, eliminating the need for manual switching
- **SL** - The drone will only use Connect SL (point-to-point)
- **5G** - The drone will only use Connect 5G (cellular)

## Band (Connect SL)

Select your radio bandwidth:

- 2.4 GHz (coming soon)
- 5 GHz
- DFS (Dynamic Frequency Selection)

## Channel

Select your radio frequency channel to avoid congestion from other signals.

Set to **Auto** by default.

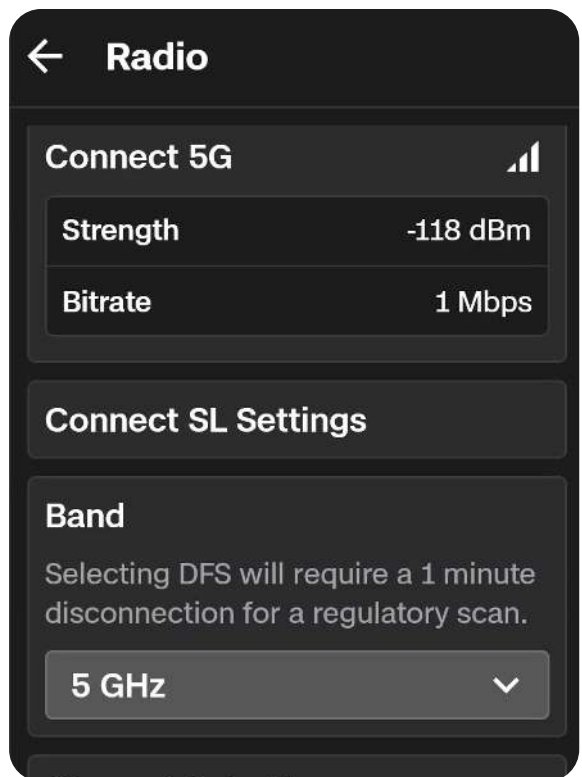
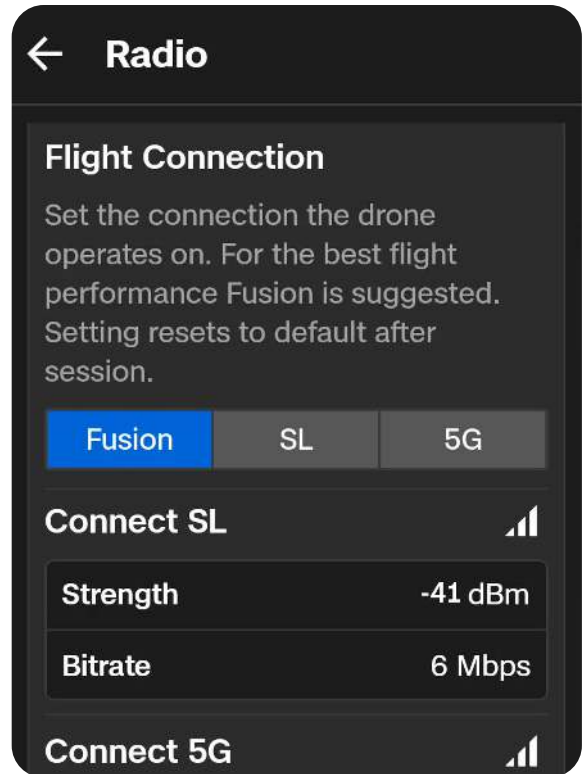

### Drone Connect 5G

Enables 5G cellular connection to the drone. For more information about setting up and flying over 5G cellular, visit: [How to fly Skydio X10 over cellular connectivity](#).

### Low Data Mode

Helps reduce instances of lost connection or high video latency when flying in locations with poor cellular coverage. Enable this toggle if you're experiencing frequent lost connections or high video latency when Drone Connect 5G is enabled.

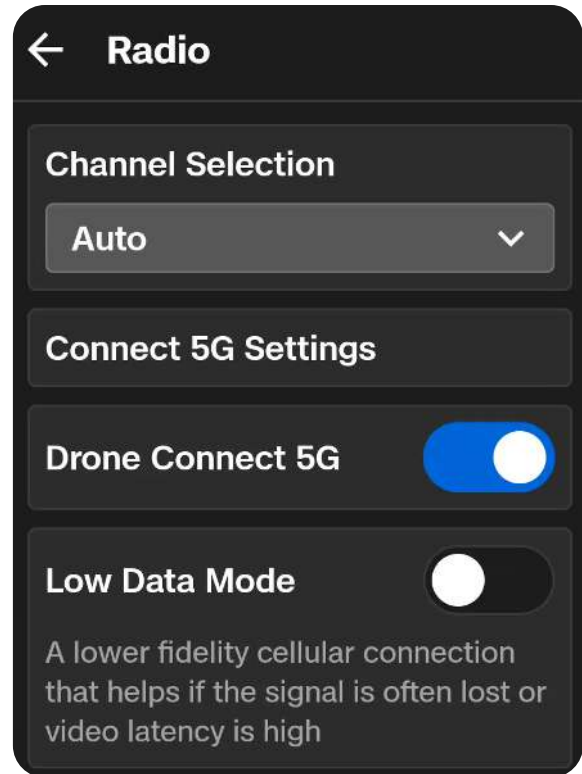

## Skydio Connect SL Frequencies

---

### 2.4 GHz (coming soon)

Auto

- 1: 2401-2423 MHz
  - 2: 2406-2428 MHz
  - 3: 2411-2433 MHz
  - 4: 2416-2438 MHz
  - 5: 2421-2443 MHz
  - 6: 2426-2448 MHz
  - 7: 2431-2453 MHz
  - 8: 2436-2458 MHz
  - 9: 2441-2463 MHz
  - 10: 2446-2468 MHz
  - 11: 2451-2473 MHz
- 

### 5 GHz

Auto

- 36: 5170-5190 MHz
  - 40: 5190-5210 MHz
  - 44: 5210-5230 MHz
  - 48: 5230-5250 MHz
  - 149: 5735-5755 MHz
  - 153: 5755-5775 MHz
  - 157: 5775-5795 MHz
  - 161: 5795-5815 MHz
  - 165: 5815-5835 MHz
- 

### DFS (Dynamic Frequency Selection)

Auto

- 52: 5250-5270 MHz
  - 56: 5270-5290 MHz
  - 60: 5290-5310 MHz
  - 64: 5310-5330 MHz
  - 68: 5330-5350 MHz
  - 96: 5470-5490 MHz
  - 100: 5490-5510 MHz
  - 104: 5510-5530 MHz
  - 108: 5530-5550 MHz
  - 112: 5550-5570 MHz
  - 116: 5570-5590 MHz
  - 120: 5590-5610 MHz
  - 124: 5610-5630 MHz
  - 128: 5630-5650 MHz
  - 132: 5650-5670 MHz
  - 136: 5670-5690 MHz
  - 140: 5690-5710 MHz
  - 144: 5710-5730 MHz
-

# Sound

Allows you to control the notification volume that plays through the X10 Controller speakers. Set the slider to zero to mute all sounds.

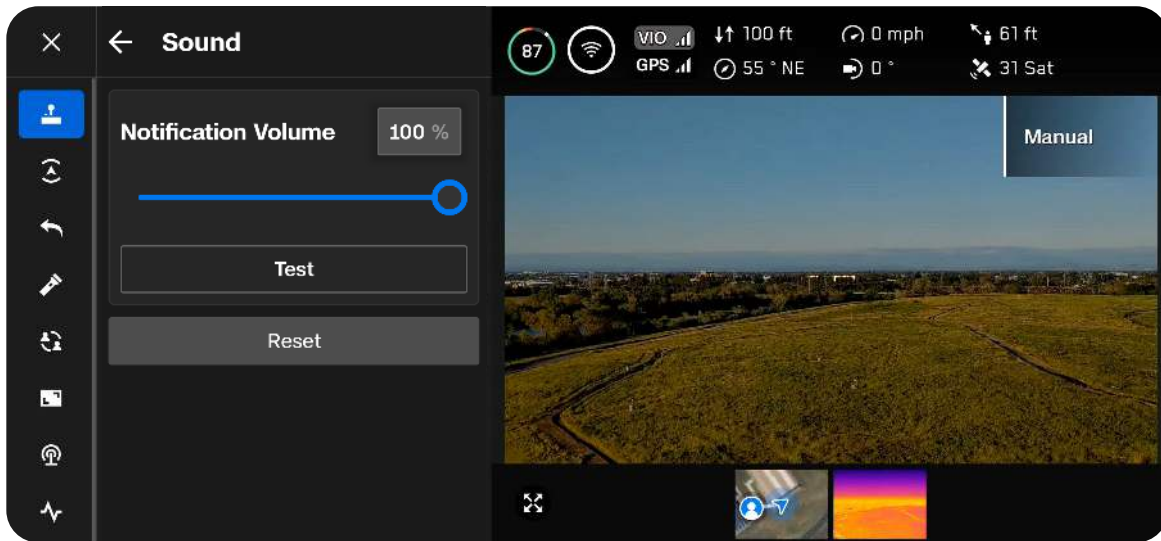

# System Status

Provides a comprehensive overview of the system at a glance.

Displays:

- Drone connection quality
- GPS signal quality and position accuracy
- Live Stream status
- Remote ID broadcast status

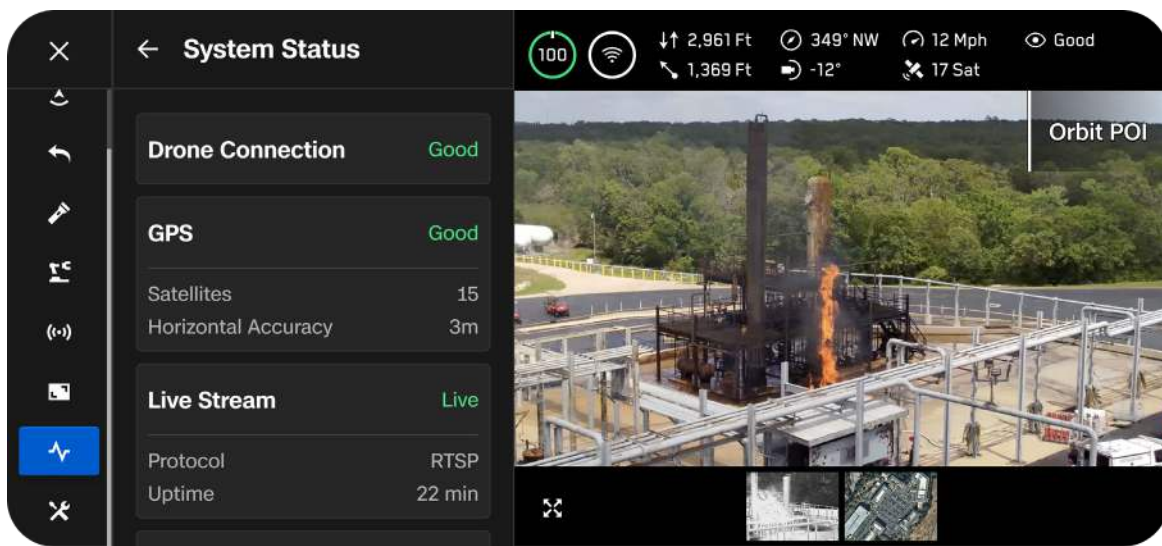

## Drone Connection

Skydio Connect SL

Refers to the connection quality between the drone and controller.

Skydio Connect 5G\*

Refers to the cellular connection quality of the drone to cellular towers.

*\*You must have purchased a Skydio X10 Controller with Connect 5G on it*

## GPS

### Satellites

Represents the count of GPS satellites that the drone is currently receiving signals from. A greater number of satellites results in a more accurate position as well as greater safety and reliability during flight.

It is important to establish a strong GPS connection, especially before flying over water.

- Connection to 13 or more satellites is considered a Good connection
- We recommend 18 or more satellites before flying over water

### Horizontal Accuracy

Quantifies the position of Skydio X10 on a two-dimensional plane. Especially useful when mapping or surveying.

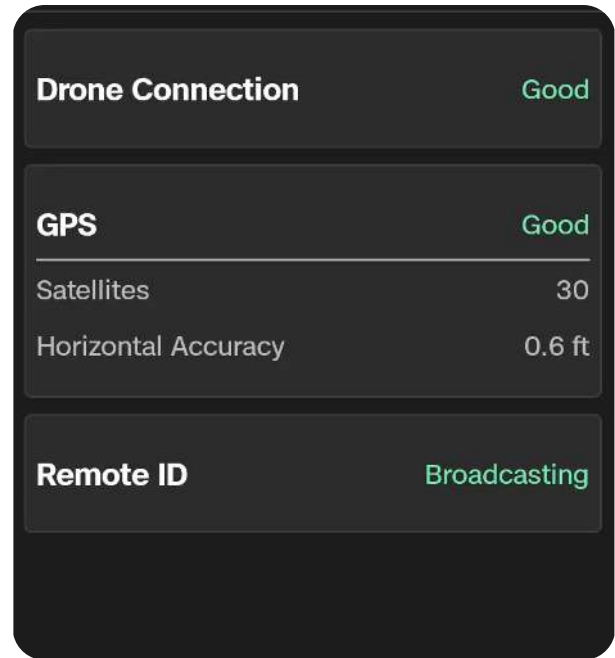

### **Remote ID**

Displays the status of Remote ID broadcasts.

Remote ID requires drones operating in U.S. airspace to identify themselves by broadcasting information that will enable the authorities to identify pilots who are not following the rules. Only authorized individuals from public safety organizations may request the identity of the owner of the drone from the FAA.

Remote ID broadcast includes:

- Launch location
- Drone ID - your Skydio ANSI serial number
- Drone location and altitude
- Drone velocity
- Control station location and elevation
- Time of operation
- Emergency status

# Quick Actions

The left sidebar of your Flight Screen contains a variety of Quick Action menus. With Quick Actions, you have the ability to quickly **toggle** a setting or **cycle** through setting options.

### Toggle

Full green bar indicates a setting is ON.



### Cycle

A menu will pop out and label the current setting. The green bars indicate the number of available settings.

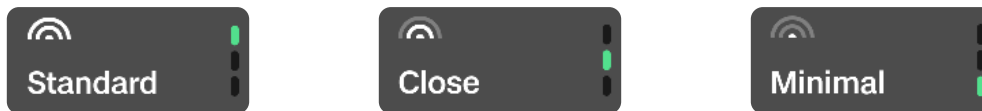

## Augmented Reality (AR) Quick Actions

Enable to visually display where Skydio X10 detects obstacles in the environment. Appears as either solid or outlined augmented reality (AR) boxes, depending on your selection within the **Display** menu.

Use the **AR Quick Action** button to cycle between the distances from which obstacles are rendered on the screen. Objects that are closer appear red.

- Off
- 0 - 6 ft (0 - 2 m)
- 0 - 13 ft (0 - 4 m)

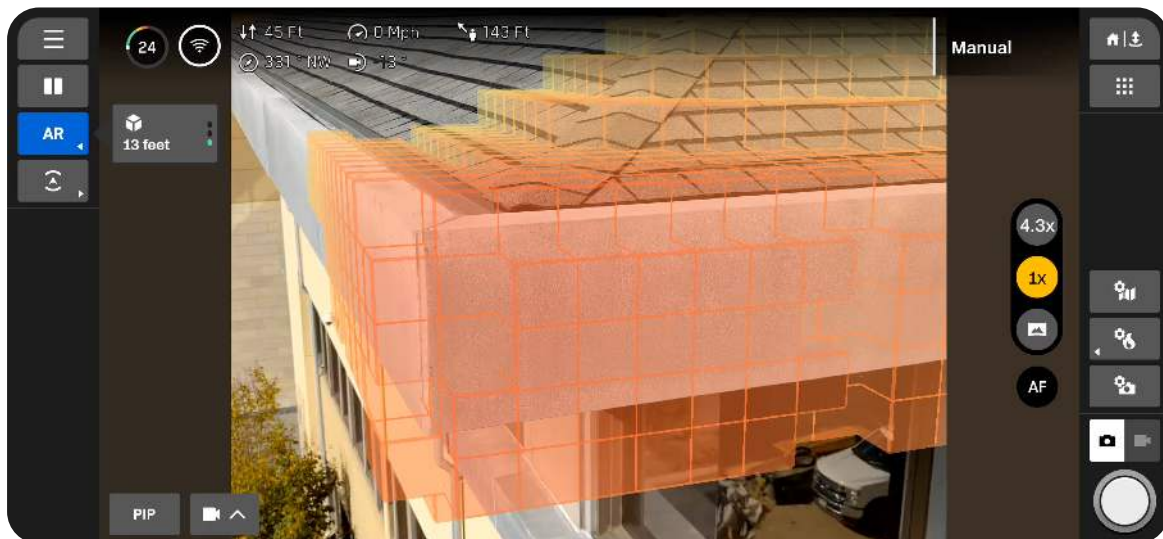
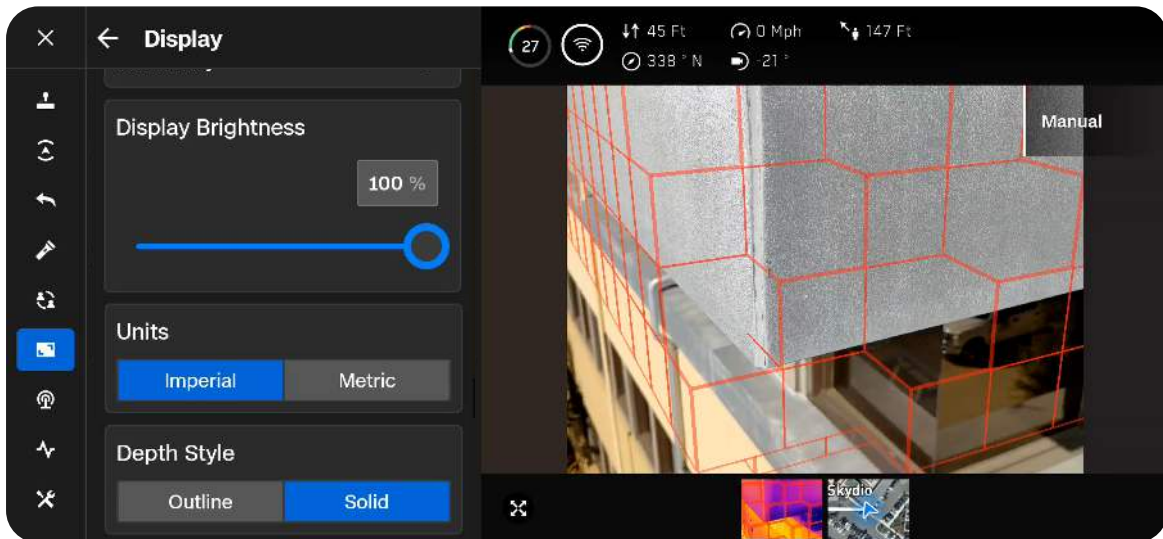

## Obstacle Avoidance Quick Actions

Quickly cycle through the three obstacle avoidance settings, available in the **Sensing** menu.

A yellow border appears when in Close or Minimal obstacle avoidance mode.

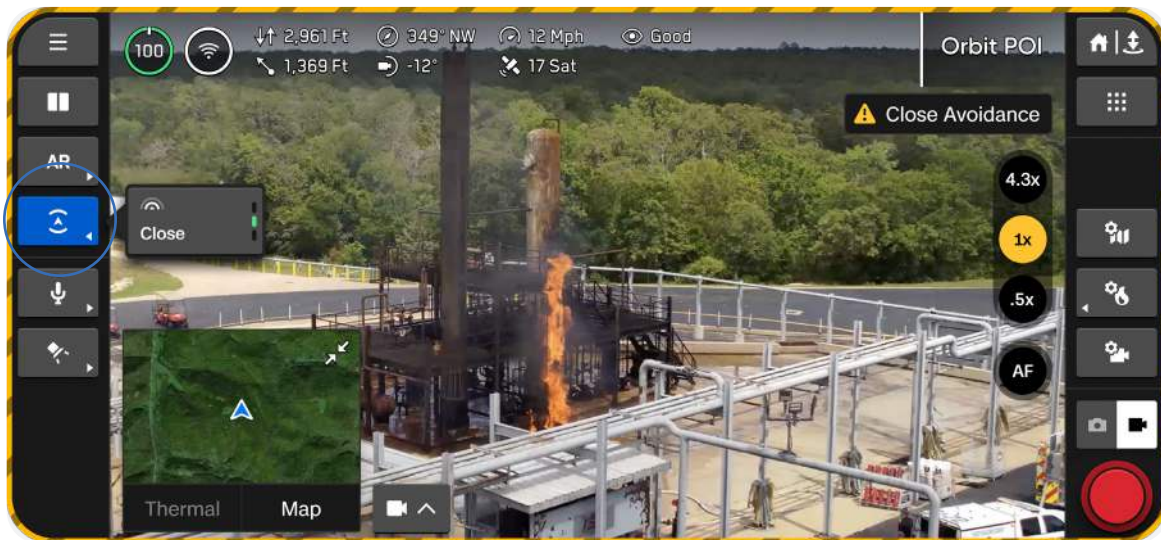

## Inflight Map

View your current location, search, set a Home Point, and configure map settings.

- The location of Skydio X10, the controller, Launch Point, and Home Point (if set) are indicated on the map
- Press and hold on a location to set a **Home Point**



Skydio X10



Controller



Launch Point



Home Point

When an aircraft enters your ADS-B alert radius (Display > Air Traffic), a series of notifications appear:

**Aircraft icon** – Displays either a fixed wing aircraft or rotorcraft

- Shows the altitude **relative** to your drone
- Select this icon to view more flight details (e.g., vertical/horizontal speed, ground distance relative to your drone)

**Visual notification** – An alert appears in the top left of the screen and displays **Incoming Aircraft**

**Audible alert** – The X10 Controller will play an audible beep, along with a spoken “Traffic”

- Mute this alert using the **Sound** menu (within Global Settings)

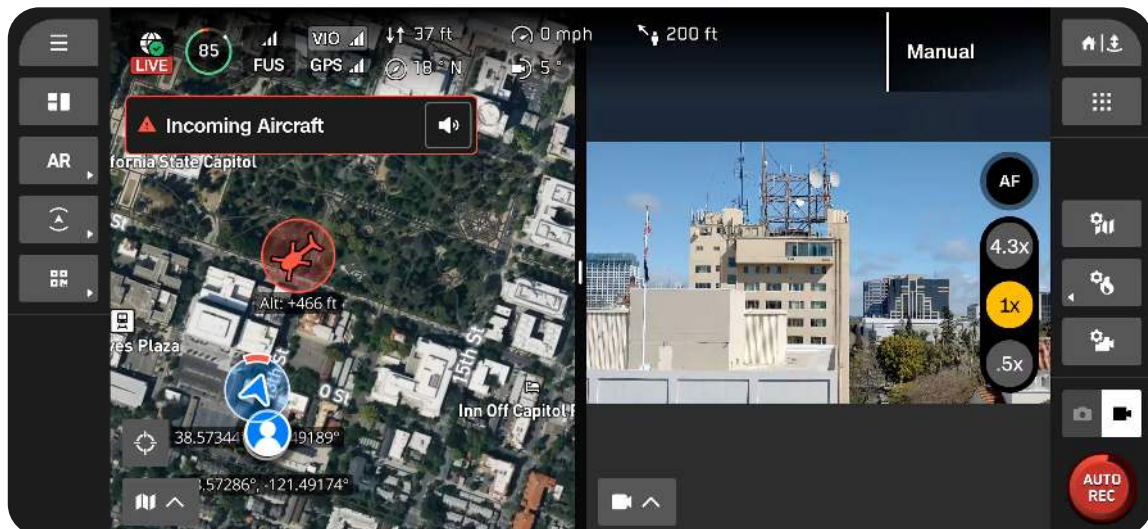

# Inflight Operations | Navigating Skydio Flight Deck

Adjust your map settings during flight using the **Map Settings** icon.

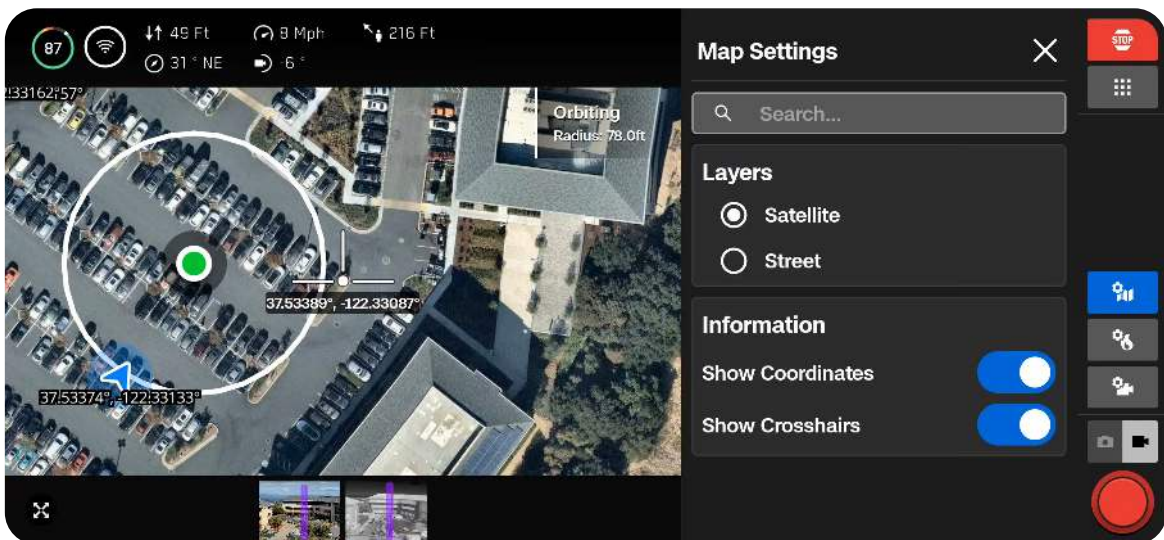
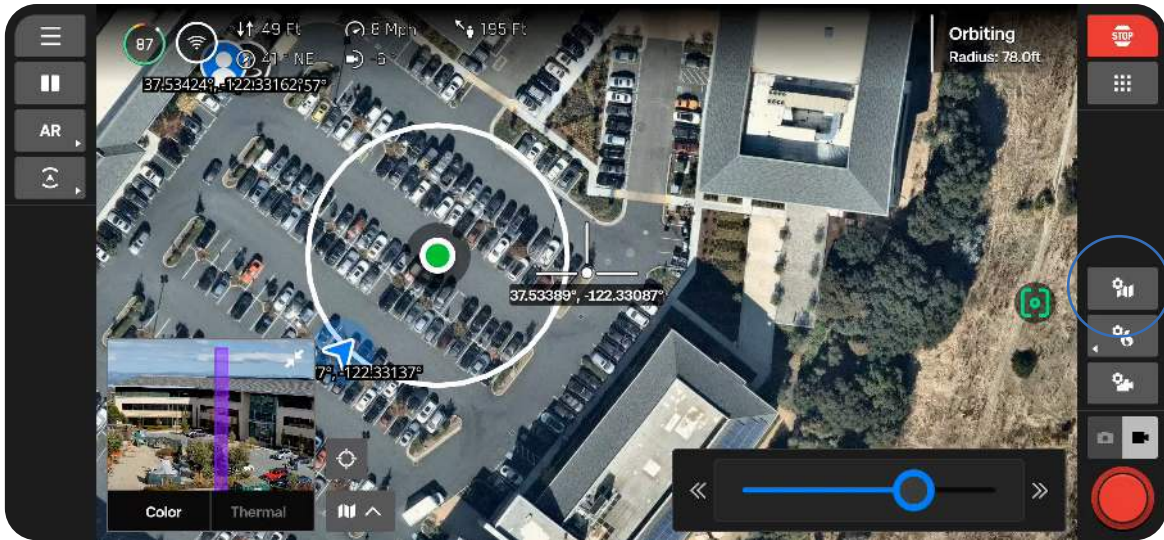

## Fly Here Now

Press and hold on the map and select **Fly Here Now** to immediately fly to that location.

The drone will always travel at 45 mph (20 m/s) during a Fly Here Now transit.

- Select anywhere along the flight path between the drone and the Fly Here Now location and add **transit points**
- Edit the altitude of the transit points or destination using the menu on the right
- Both the Fly Here Now point or transit points are draggable



**NOTE:** The drone will fly at maximum speed while executing a Fly Here Now mission.

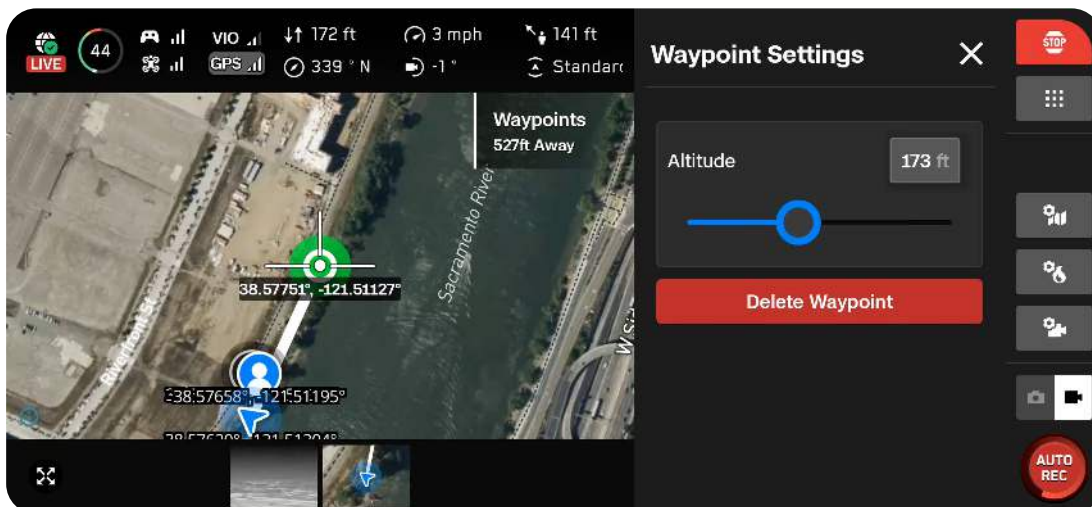
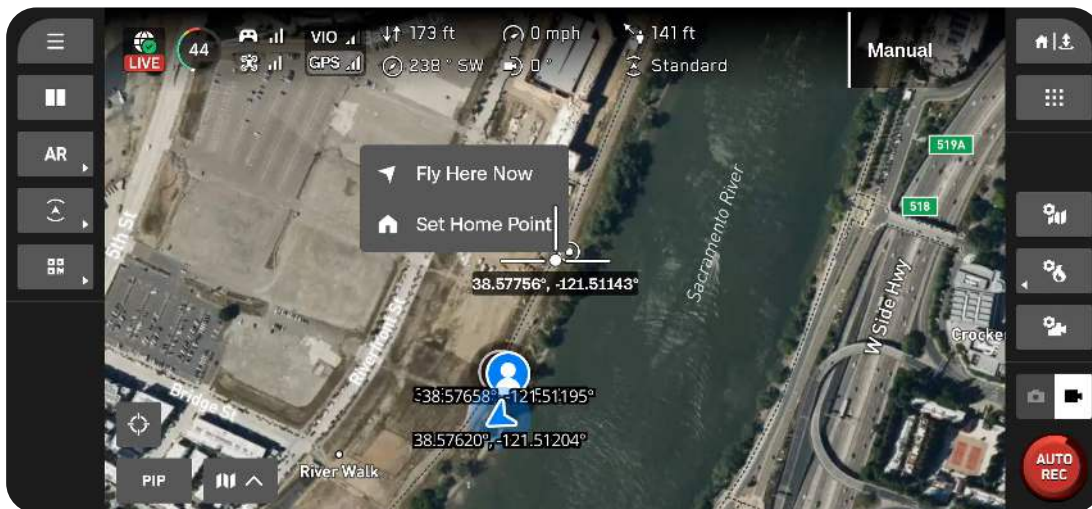

### Fly Here Now

Press and hold on the map and select **Fly Here Now** to immediately fly to that location.

- Select anywhere along the flight path between the drone and the Fly Here Now location and add **transit points**
- Edit the altitude of the transit points or destination using the menu on the right
- Both the Fly Here Now point or transit points are draggable

# Camera Settings

Learn how to adjust photo and video settings such as zoom, exposure, ISO, and resolution.

Pilots must understand:

- Capture Settings (Photo and Video)
- Focus and Exposure
- Zoom Settings (Photo and Video)
- Shutter Indicators
- Photo Settings
- Video Settings
- Sensor Package Flashlights

## Overview

When your drone captures a photo or video, it will save one image file with the color camera. Two files will save if you have JPG and DNG enabled. If you would like Skydio X10 to also capture an image file with the thermal camera, enable **Thermal Capture** within the **Thermal Settings**.

Use **Camera Mode** on the right sidebar to switch between photo or video. Skydio X10 can capture photos or videos but not both at the same time. Your color and thermal cameras will always be in the same Camera Mode.

Access your photos and videos using the **Media** menu located in **Global Settings**.

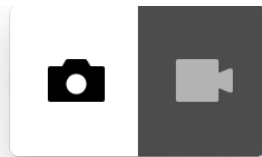
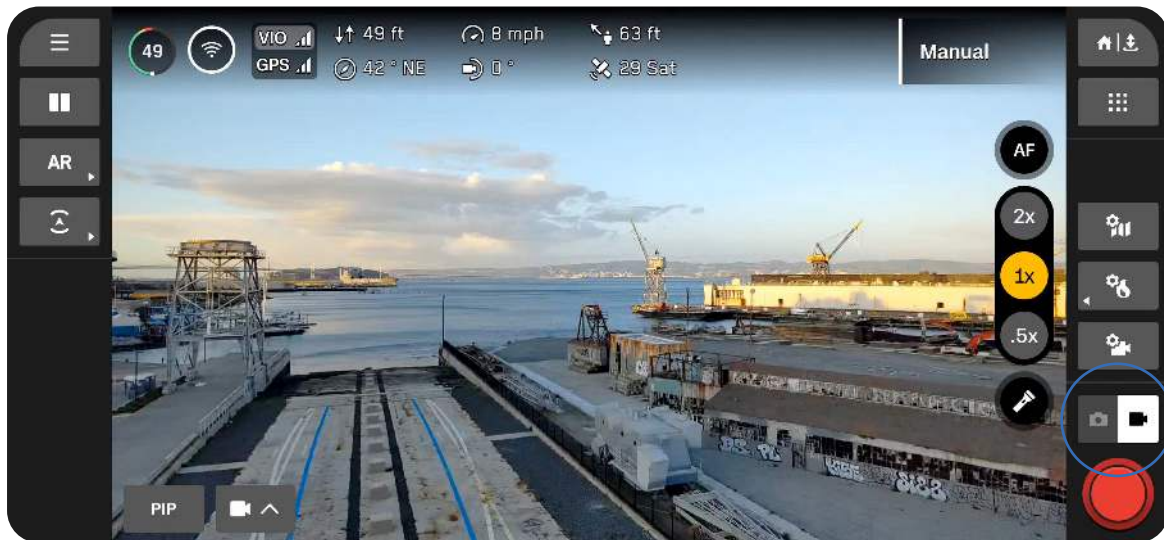

Photo enabled



Video enabled



**NOTE:** Photo and Video mode settings are independent of each other and persist through mode changes, but not power cycles.

# Capture Settings (Photo and Video)

### Brightness Exposure Value (EV)

Refers to the amount of light the camera allows in.

Negative numbers result in darker images (less exposure) while positive numbers result in brighter images (more exposure).

- Brightness is set to Auto by default

### White Balance

Balances the color temperature in your photo. If the whites in your picture are too orange, for example, adding the opposite color (blue) will balance them out.

Lower values result in a cooler (blues) image while higher values result in a warmer (yellows) image.

- Auto (default) means Skydio X10 will automatically adjust the White Balance for its environment

### ISO

Brightens or darkens your photo. When in low-light conditions, raising the ISO value will brighten the image, however you may see some graininess.

- Auto means Skydio X10 will automatically adjust the ISO for its environment

### Shutter

Refers to the length of time a photo is exposed.

Slower shutter speed means greater exposure, while faster shutter speed means less exposure.

- Auto means Skydio X10 will automatically adjust the Shutter speed based on the available light

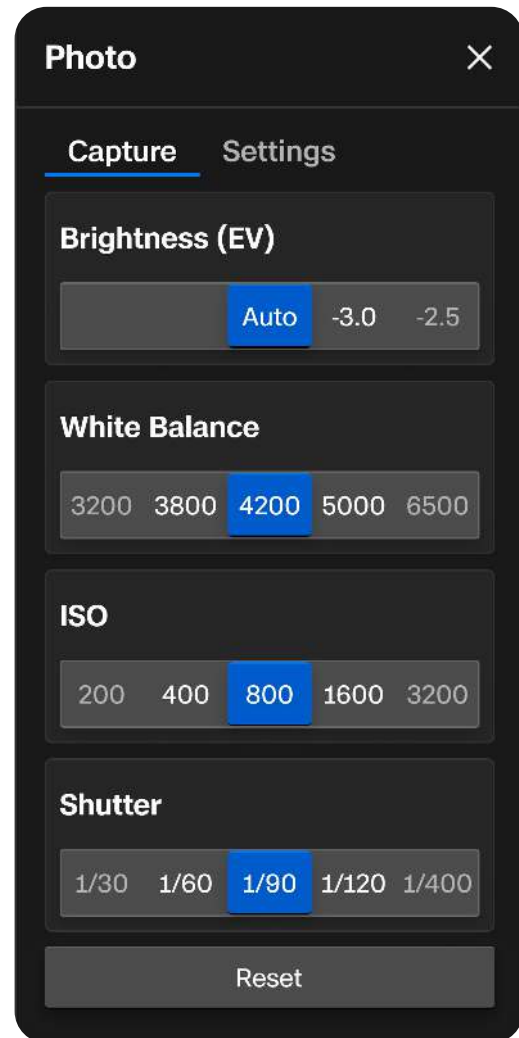

## Focus and Exposure

To view the various focus options, select the Focus Control button on the right side of the Flight Screen.

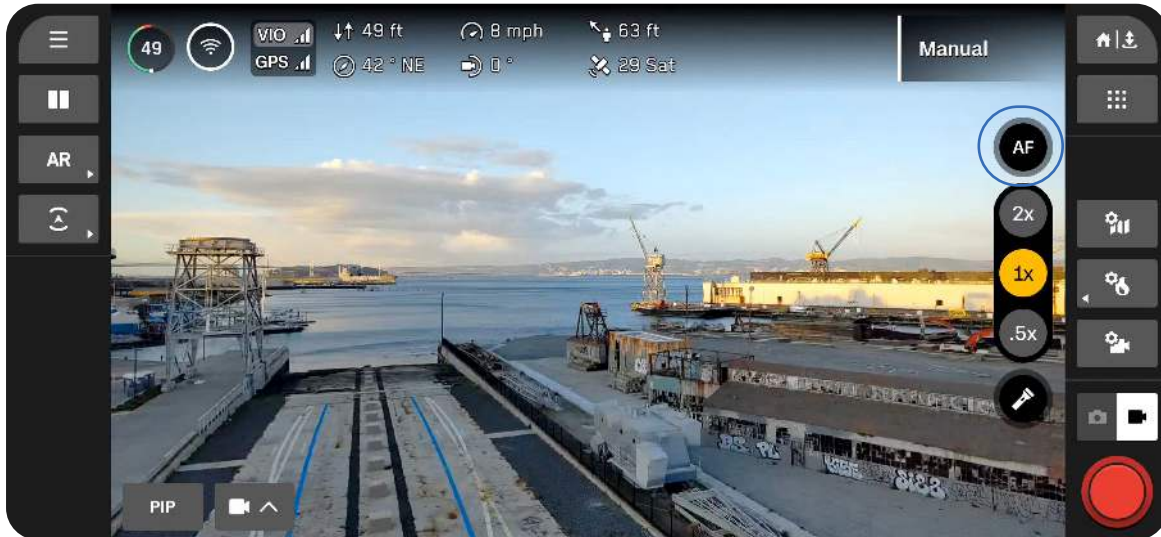

### AutoFocus (AF)

By default, your camera will be set to automatically adjust focus and exposure. In this focus mode, focus will generally prioritize objects in the center of the screen.



### Manual Focus (MF)

After selecting the Manual Focus icon, a focus slider will appear:

- Drag the slider to adjust the plane of focus
- Select outside the slider to return to the full parameter view
- To go back to Auto focus, select the Focus, Manual box again



### Tap to Focus

Touch anywhere on the screen to focus on an area of interest, or select the icon to center. The Focus Indicator will turn green once the image is sharp and clear.



### Manual Capture Controls

The Manual Focus option provides you with greater control over image settings. Switch between AutoFocus and Manual Focus at any time.

#### Switching Modes

Select the Focus Control button to switch between Auto and Manual focus. In Manual Focus, you control:

- Exposure Value (EV)
- ISO
- White Balance (WB)
- Shutter Speed

#### Touch Controls

- Select the parameter box you wish to control (EV, ISO, WB, Shutter Speed)
- A value selector will appear; drag up or down to set your value
- Select outside of the selector to confirm and return to the main control view
- A **lock icon** indicates a manual value, select the lock to return the parameter to Auto

#### D-Pad Controls

From Auto mode, press down on the D-Pad to toggle into Manual mode. The active parameter is highlighted with a yellow border. Use the D-Pad to:

- Press down to open a parameter's value menu
- Press up or down to scroll through available values
- Press down again to confirm
- Press down repeatedly to cycle focus between parameters

## Zoom Settings (Photo and Video)

To zoom in digitally, place your finger on the right controller wheel and push it to the left. Customize this using Input Mapping (Flight Controls > Controls).

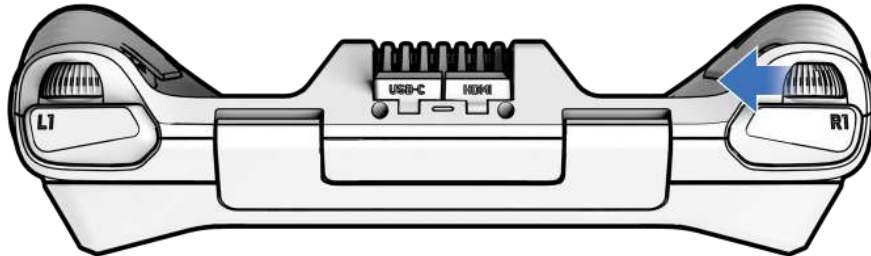

Quickly snap to a zoom level using the Zoom buttons on the right side of the screen.

### VT300-Z Sensor

- 4.3x - transitions between narrow and telephoto lens, 128x max system zoom
- 1x - default zoom level of narrow lens
- .5x - Surround Vision

### VT300-L Sensor

- 2x - transitions between wide and narrow lens, 64x max system zoom
- 1x - default zoom level of wide lens
- .5x - Surround Vision



**NOTE:** Images and videos taken while zoomed in will be saved at that zoom level.

## Surround Vision

Surround Vision uses Skydio X10 navigation cameras to generate an ultra-wide view of your environment for situational awareness.



**NOTE:** Photos and videos captured when in Surround Vision will be saved at 1x zoom.



## Thermal Zoom

The thermal camera will zoom up to 16x, but you may continue to zoom using the color camera. If any Tools are enabled, such as Region of Interest, they will dynamically adjust to fit the screen as you zoom.

## Shutter Indicators

The Shutter is located in the bottom right of the Flight Screen and indicates the current state of Photo or Video mode.

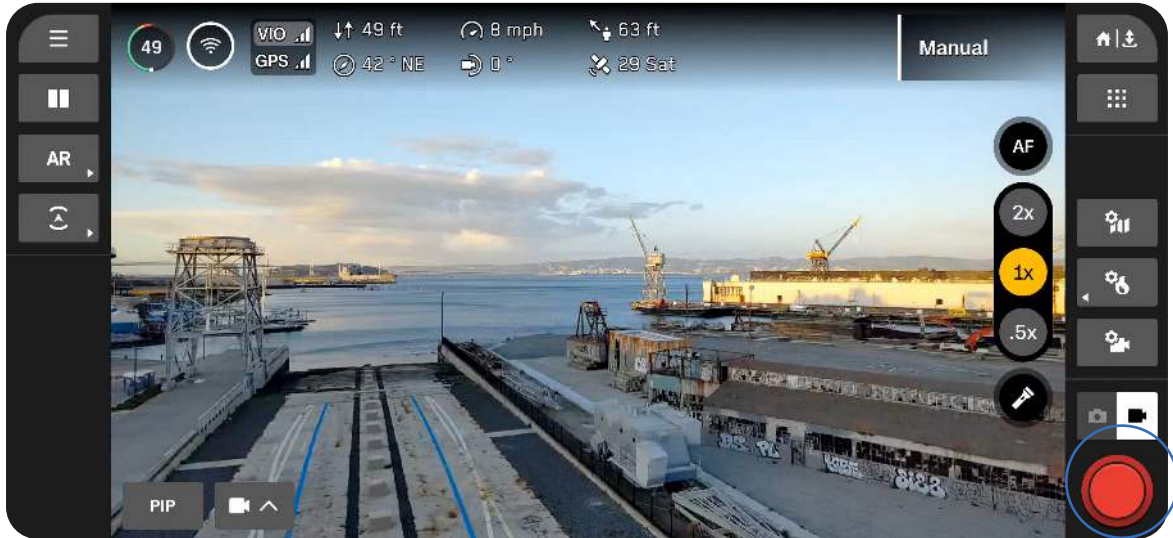

### Photo

Ready for Capture



Pressed



Disabled



Interval



### Video

Manual Record



Manual Record (Pressed)



Recording



Recording (Pressed)



Auto Recording



Auto Recording (Paused)



**NOTE:** You have the ability to enable Shutter Sounds when capturing photos within Photo Settings.

## Photo Settings

### Save to Custom Folder

You have the ability to create a custom folder preflight or inflight. This folder will be saved on the **Media card** under DCIM > [Custom Folder Name].

All photos and videos captured **after** creating a custom folder will automatically save to this new folder. To revert to default, select **Revert to Media**.

- If you do not enter a custom folder name, media will be saved in DCIM > 100XSKYDO
- Does not apply to photos captured in 3D Scan

### File Type

Choose whether you want Skydio to capture JPG images only, or both JPG and DNG files.

- **JPG** - Digital image format containing compressed image data.
- **DNG** - RAW image format file, meaning it is not compressed and retains all original photo data. A DNG file is larger than a JPG file since it stores image data.

### Resolution

Refers to the amount of detail in your video. Measured in megapixels.

- **Full** - Images are captured at the highest quality, providing more detail and clarity.
- **1/4** - Images are captured at one-fourth of the full resolution, resulting in smaller file sizes. Best for conserving storage space or transmitting images faster.

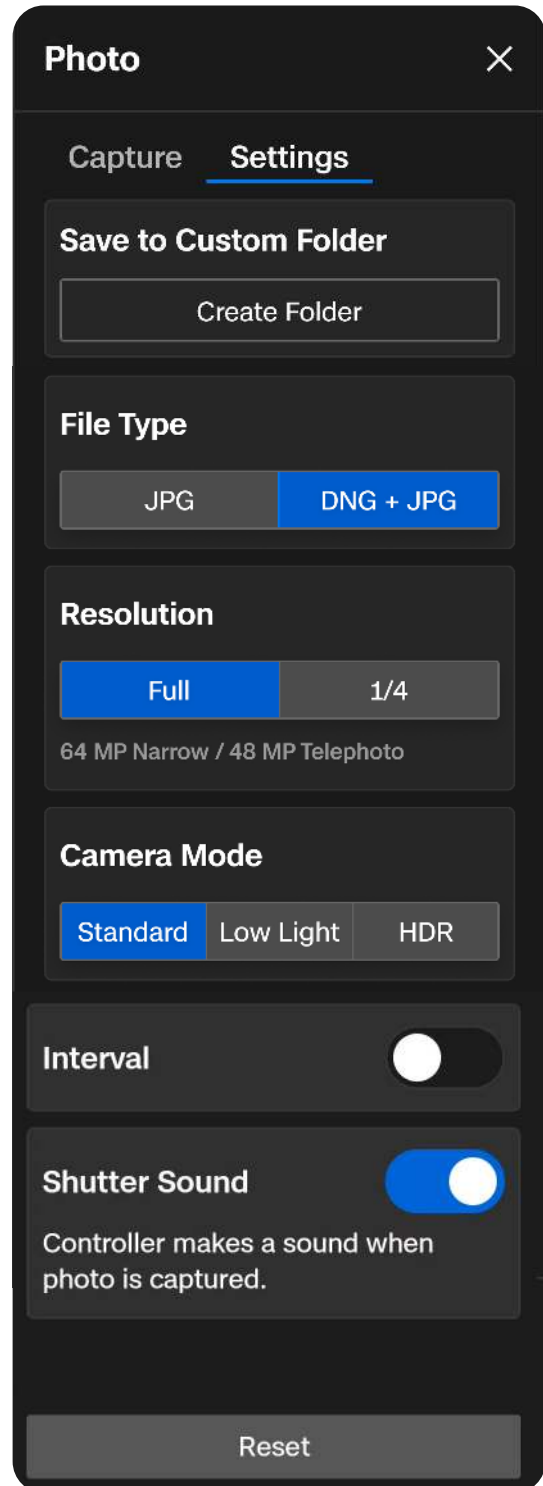

### Camera Mode

- **Standard** - Designed for typical, everyday lighting conditions. Provides a balanced, standard level of exposure, image processing, and contrast.
- **Low Light** - Designed for environments with dim lighting, such as indoors or evening. Settings are adjusted to capture more light, reduce noise, and improve visibility. Only available with 1/4 Resolution.
- **HDR** - Designed to capture environments with a wide range of brightness levels. Only available with 1/4 Resolution.

### Interval

When enabled, Skydio X10 will continuously capture photos at the specified time interval until the setting is disabled or the flight ends.

### Shutter Sound

When enabled, you will hear a shutter sound when capturing photos, providing instant confirmation that an image has been taken.

- Enabled by default
- Sound only plays through the controller speakers, not through connected headsets

## Video Settings

### Auto Start Recording

When enabled, Skydio X10 will record video automatically.

When disabled, tap the on-screen Shutter button or on the controller (R1 button) to start/stop video recording.

### File Type

Select between H.264 and H.265 compression formats, depending on your preferences for video quality, file size, and playback compatibility.

- **H.264** - Provides manageable file sizes without sacrificing video quality. Recommended for standard video recording, and compatible with most devices and video editing software.
- **H.265** - Ideal for high-quality video capture and maintains efficient compression.

### Resolution

Select between 4K and Full HD, which refers to the amount of detail in your video. Measured in pixels.

- More pixels result in a high-resolution video
- Fewer pixels result in a lower resolution video

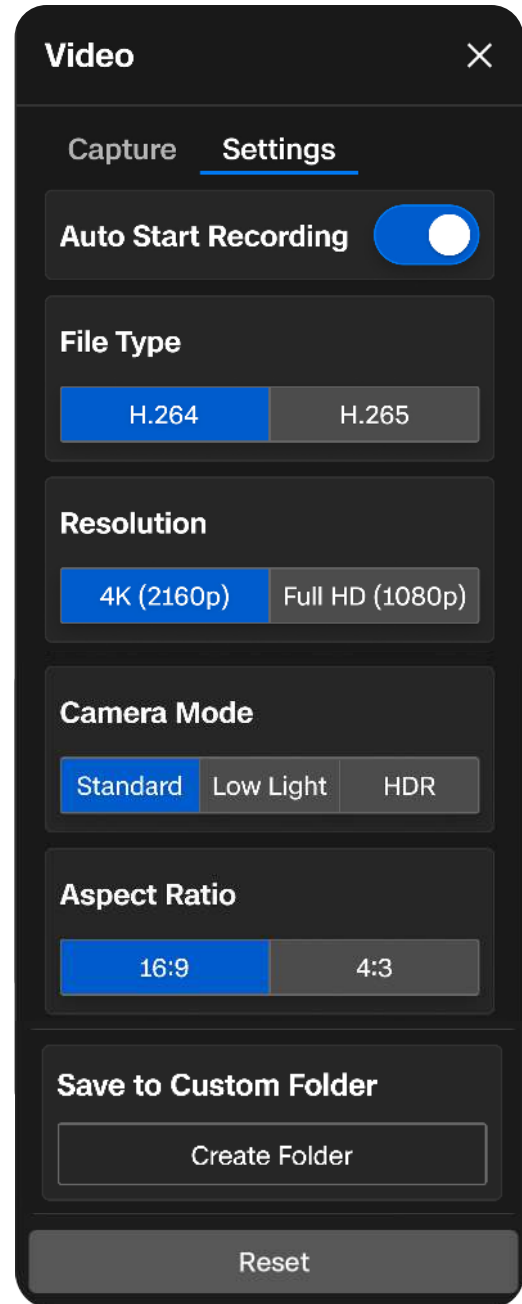

### Camera Mode

- **Standard** - Designed for typical, everyday lighting conditions. Provides a balanced, standard level of exposure, image processing, and contrast.
- **Low Light** - Designed for environments with dim lighting, such as indoors or evening. Settings are adjusted to capture more light, reduce noise, and improve visibility.
- **HDR** - Designed to capture environments with a wide range of brightness levels.

### Aspect Ratio

Sets the shape and framing of your video.

- **16:9** - Provides a wider, broader field of view.
- **4:3** - Provides greater FOV in the vertical axis, resulting in more square-shaped framing. Images are taller, as opposed to wider.

### Save to Custom Folder

You have the ability to create a custom folder preflight or inflight. This folder will be saved on the **Media card** under DCIM > [Custom Folder Name].

All photos and videos captured **after** creating a custom folder will automatically save to this new folder. To revert to default, select **Revert to Media**.

- If you do not enter a custom folder name, media will be saved in DCIM > 100XSKYDO
- Does not apply to photos captured in 3D Scan

### Using the Flashlight on VT300-L or V100-L Sensor Packages

The VT300-L and V100-L sensor packages comes equipped with an onboard flashlight, providing effective illumination up to 10 ft (3 m) and enabling inspections in low-light environments.

Select the on-screen flashlight icon to turn the flashlight on or off in flight.



**NOTE:** The flashlight can only be controlled during flight and will not be operational on the ground nor during launch and landing.



**WARNING:** When using the flashlight on the VT300-L or V100-L sensor packages, do not stare directly into the light at any range for any extended period of time.



**WARNING:** After prolonged use of the flashlight, your sensor package may be hot to the touch and could present a serious burn risk. After landing, wait for your sensor package to cool down before handling.

# Thermal Camera and Tools

The thermal camera with Skydio X10 includes a powerful suite of tools, such as radiometric capabilities, to assist you in a variety of use cases.

Pilots must understand:

- Accessing Thermal Options
- Flat Field Correction (FFC)
- Thermal Tools
- Thermal Settings
- Thermal Parameters

# Accessing Thermal Options

Quickly access your Thermal Tools and Settings using the quick action button located on the right side of the Flight Screen.

## Step 1 - Select Thermal Settings

Easily enable some settings using the quick actions that appear, or access the full menu.

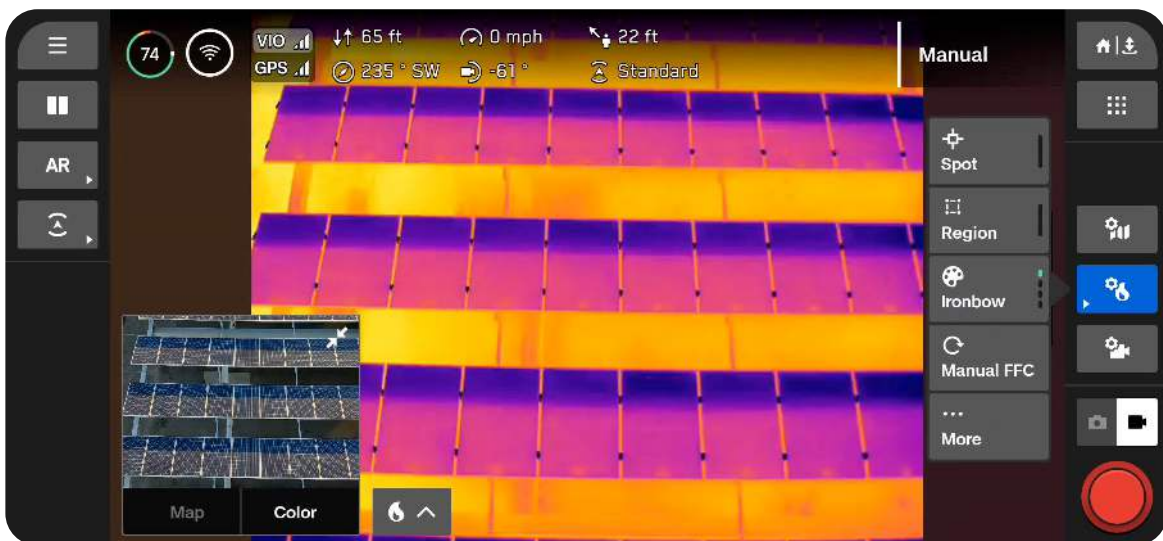
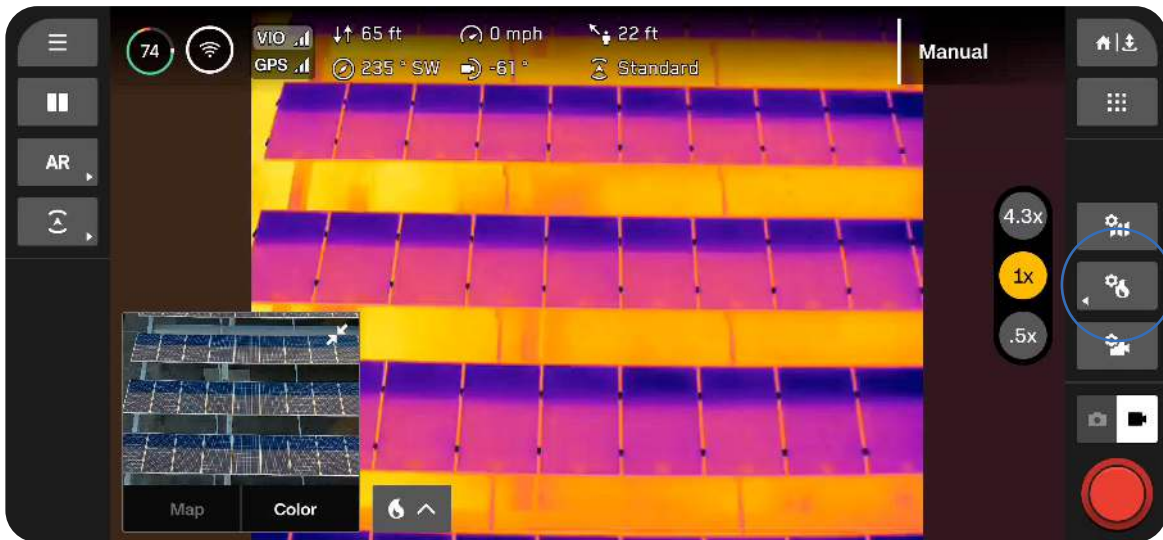

## Step 2 - Select More

Use the tabs at the top to customize your Tools, Settings, and Parameters.

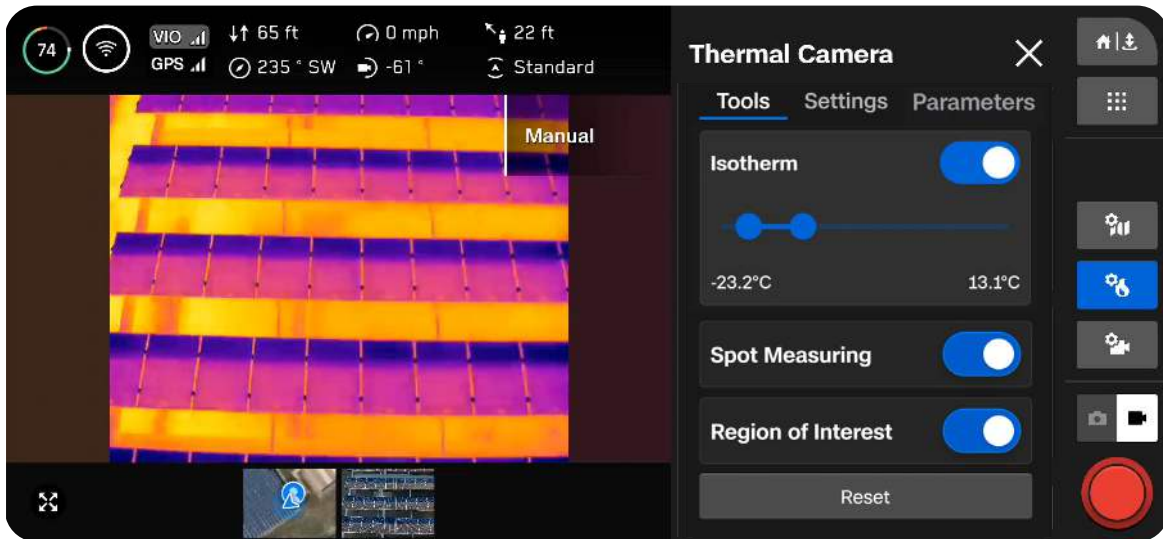
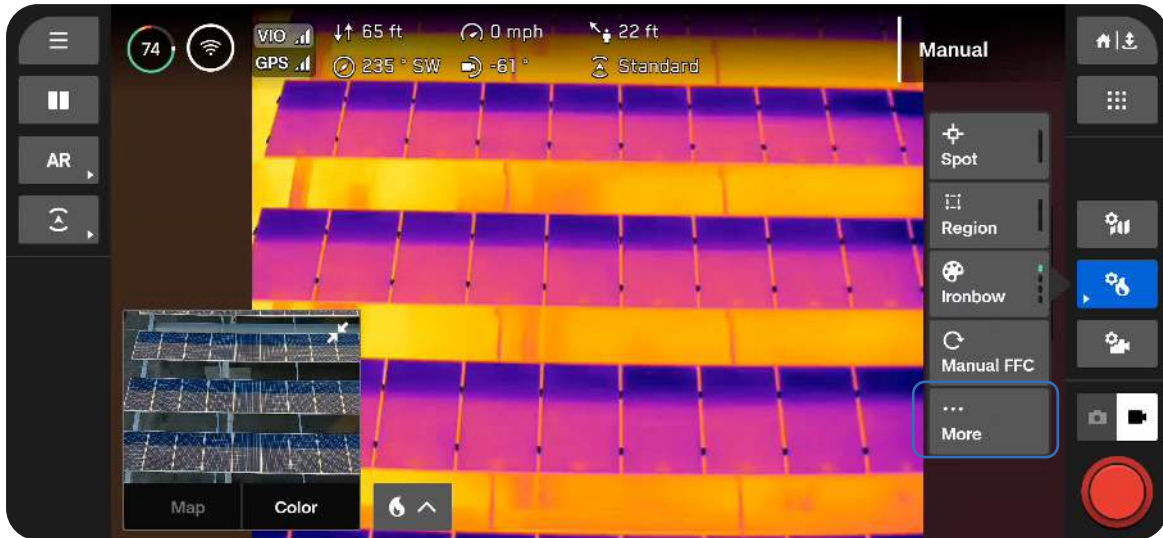

### Flat Field Correction (FFC)

Flat Field Correction (FFC) mitigates and compensates for errors that build up over time during the thermal camera operation. This is performed in the background automatically at lower zoom levels, however, you can use the Thermal Settings to manually perform FFC at any time.

Before launching, your drone will complete an automatic FFC. As a result, you may hear a light clicking sound coming from the sensor package as this completes.



**NOTE:** If you manually perform FFC, the actuation of the shutter may be noticeable on the image at higher zoom levels.

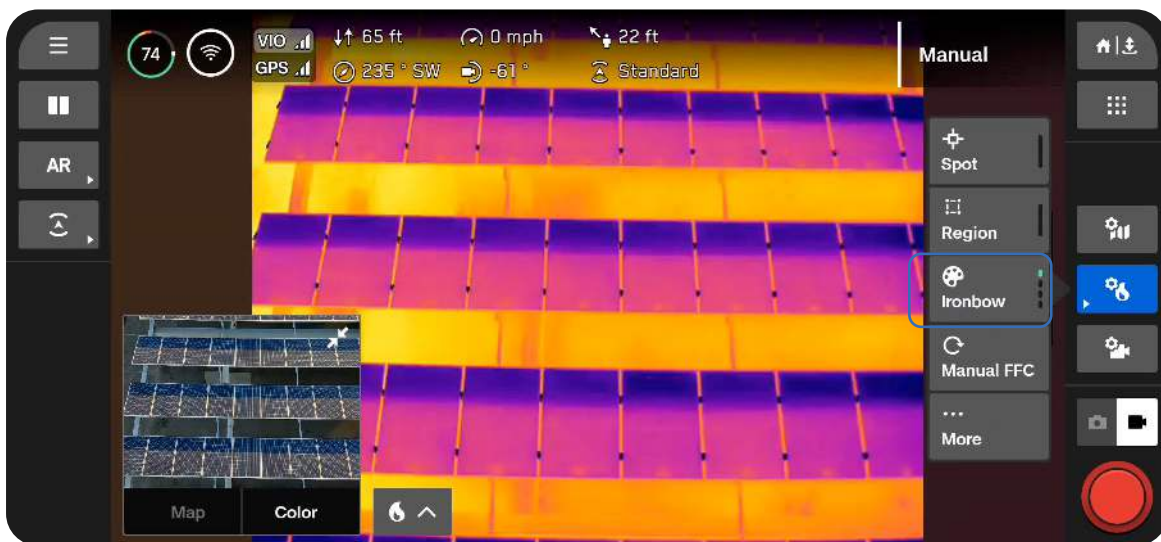

# Thermal Tools

## Isotherm

Allows you to set a range of temperatures to detect. Use this setting to omit unwanted data outside of the specified range.

The defined range will appear as the currently selected palette.

- Temperatures outside of the defined range will appear as the default White Hot or Black Hot palette
- If White Hot or Black Hot are currently selected, the temperatures in the Isotherm range will default to Rainbow

## Spot Measuring

Enable to display the specific temperature value of an object on-screen as you drag your finger on-screen.

- Tap or drag your finger across the screen to view temperatures

## Region of Interest

Enable to display an on-screen box that detects the minimum, maximum, and average temperatures within the outlined area

- **H** represents the highest temperature detected
- **L** represents the lowest temperature detected
- **A** indicates the average temperature detected
- Select the edges of the box to resize, or use the arrows to drag the box to a different location

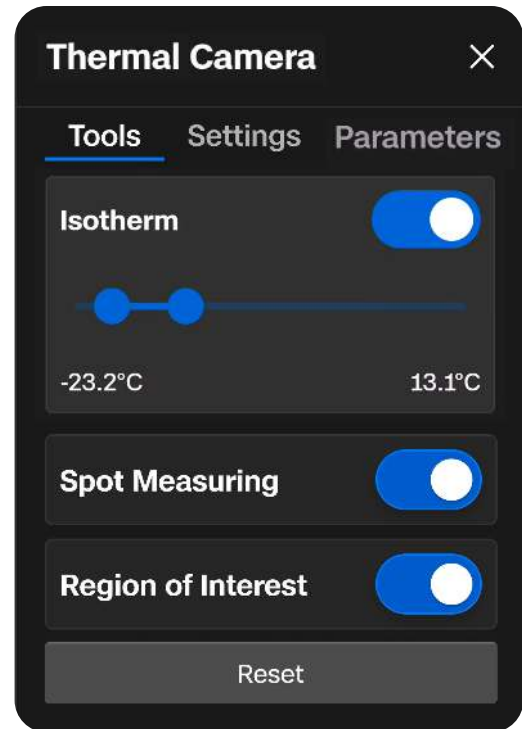

## Spot Measuring



## Region of Interest

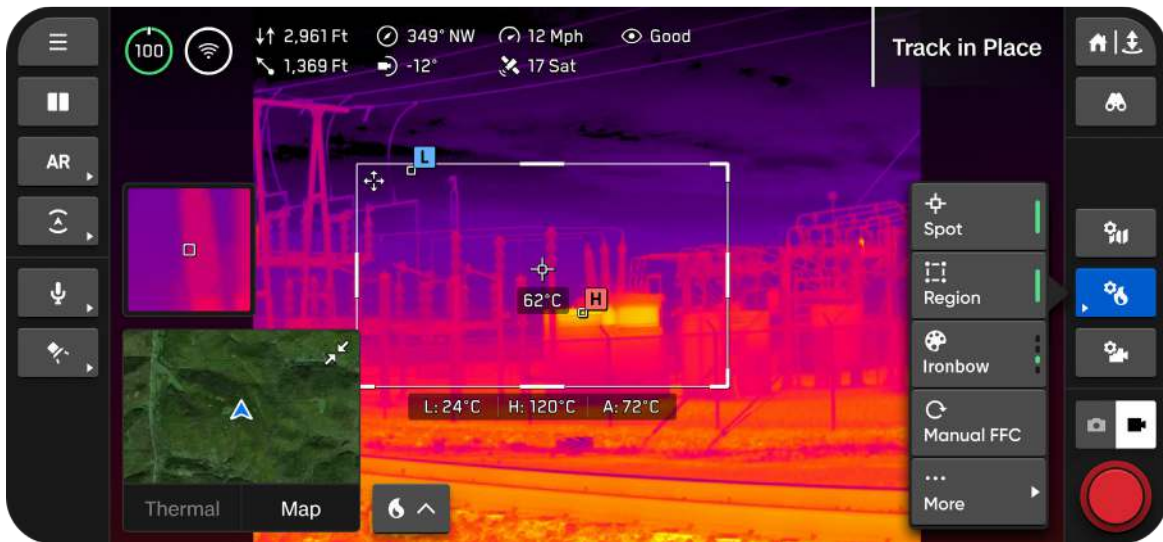

# Thermal Settings

## Color Palette

Visual representations of temperature variations captured by a thermal camera

**Ironbow** - Quickly identify varying temperatures and spot thermal anomalies. Displays a specific range of colors, from blues to reds, which indicate different temperature levels.

- Warmer objects are presented in lighter colors and colder objects in darker colors

**Rainbow** - Uses the colors of a traditional rainbow to distinguish between subtle variations in temperature levels.

- Covers a broader range of colors without emphasizing specific temperature ranges

**White Hot** - Provides a clear visualization of temperature variations without a variety of colors.

- Brighter, whiter colors indicate warmer temperatures
- Darker colors represent cooler temperatures

**Black Hot** - Displays the inverse of a White Hot palette.

- Brighter, white colors indicate cooler temperatures
- Darker, black colors represent warmer temperatures

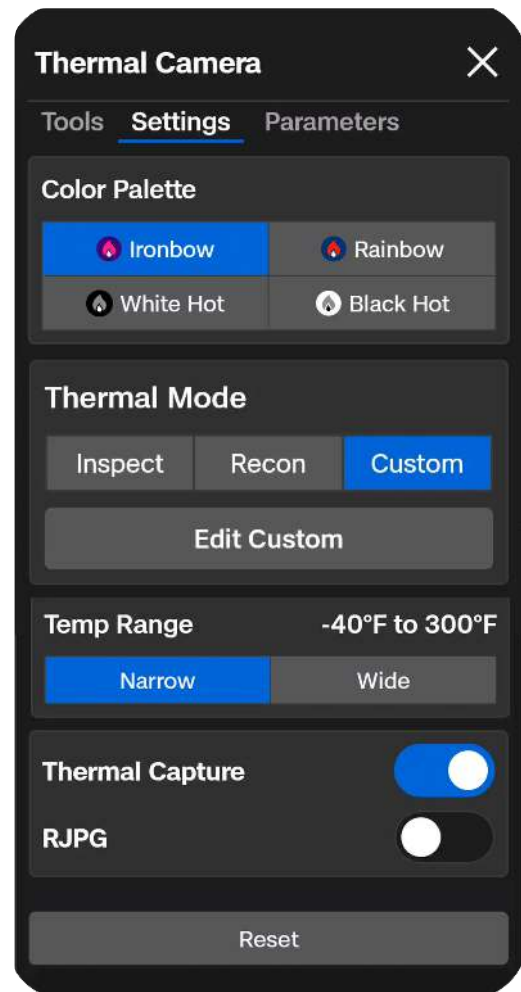

### Thermal Mode

Adjust the signal amplification from the camera sensor to enhance temperature differences in an image.

**Recon** - Tuned to increase the contrast between the overall scene and targets. Best for search and rescue or situational awareness use cases. Recon helps differentiate the scene from things like people, vehicles, or animals.

**Inspect** - Tuned to decrease the overall contrast so that temperature anomalies are easier to identify in inspection use cases. This makes it easier to not only see the anomaly, but help track the source from the heat signature.

**Custom** - Allows you to fine-tune your Gain, High Tail, and Low Tail settings. Select Inspect or Recon as your Base Mode, then adjust your Gain, High Tail, and Low Tail settings from there. These settings will persist across flights and will be applied each time you select Custom as your Thermal Mode.

- Gain - Artificially increases contrast of areas with similar temperatures
- High Tail - Adjust saturation of the hotter items in the scene
- Low Tail - Adjust saturation of colder items in the scene

### Temp Range

Select the range of temperatures Skydio X10 will detect.

**Narrow** - Detects temperatures ranging from -40°F to 302°F (-40°C to 150°C)

**Wide** - Detects temperatures ranging from -40°F to 662°F (-40°C to 350°C)

### Thermal Capture

Enable to capture thermal images as JPG files.

**RJPG** - When enabled, your drone will capture a Radiometric JPG in addition to a standard JPG. A Radiometric JPG includes the radiometric data within the photo file.

# Thermal Parameters

## Emissivity

The measure of how efficiently an object emits thermal radiation. Adjust to match the camera readings to the true temperature of the object.

- Higher values means the camera is more sensitive to temperature variations
- Lower values means the camera is less sensitive to temperature variations

Surfaces that are better emitters (higher emissivity) provide more reliable temperature readings. For example, black electrical tape, rusted or oxidized surfaces, bodies of water, or human skin all absorb and emit energy. Set your emissivity high for these types of surfaces.

Reflective surfaces are not good emitters (low emissivity) and therefore not as reliable to measure. Stainless steel, shiny surfaces, or reflective windows tend to have a low emissivity. Set your emissivity low for these types of surfaces, but we recommend gathering your reading from a higher emissivity surface whenever possible.

## Humidity

Set your humidity to accurately reflect the environment you are flying in. This should be the humidity between the sensor and the target.

Humidity is an important parameter to set because your thermal sensor will detect atmospheric conditions like humidity (and distance) which can affect the accuracy of your reading.

## Distance

Set your distance to accurately reflect the range from your thermal sensor to the target.

The further away the target is, the more atmosphere your thermal camera will pick up along the way to the target which can affect the accuracy of your reading.

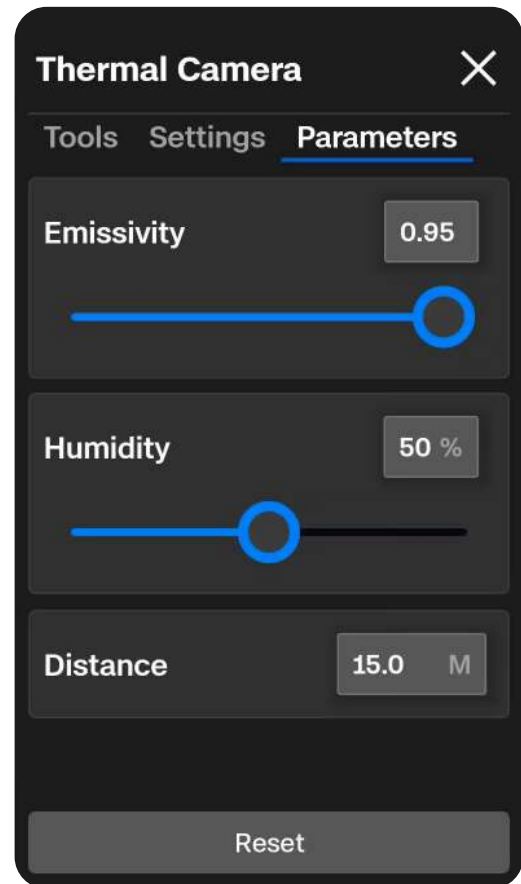

# Launching



**NOTE:** Before your first flight, make sure to set your Return and Lost Connection Behaviors (Global Settings > Return). Scan the QR Code for more information about Return and Lost Connection Behaviors.



## Step 1 - Find a clear, safe area to launch

Find a clear, safe area to launch and place your drone on a stable surface. Leave about 10 ft (3 m) of clearance in all directions.

Use the Signal Strength icon to select your connection type (2.4/5 GHz Connect SL or Connect 5G), then select **Fly Now**.

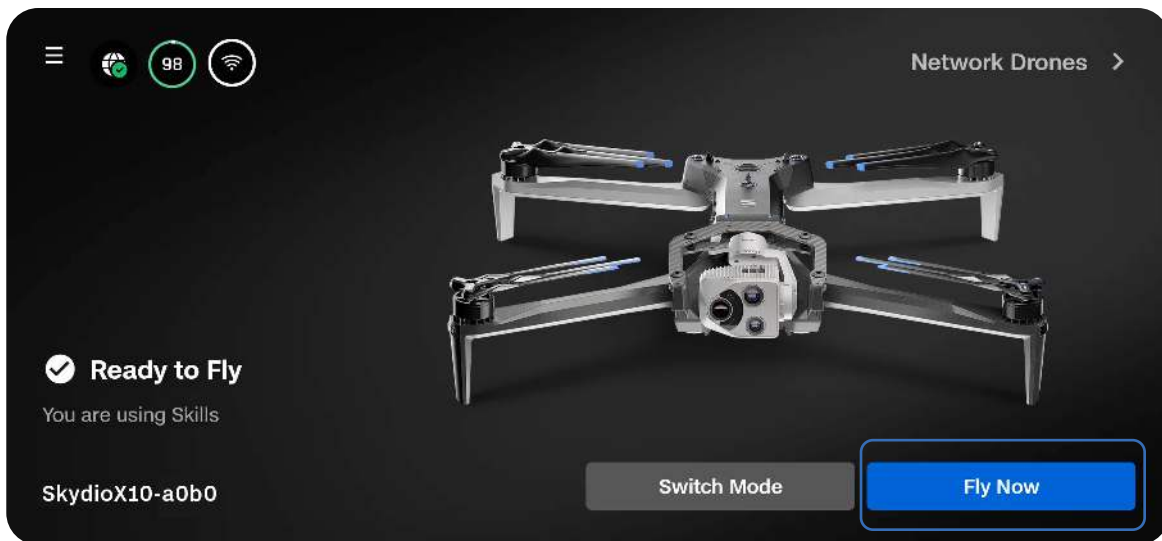

**WARNING:** Skydio X10 is capable of launching with as little as ~6 ft (2 m) of vertical clearance. However, this capability is intended for constrained environments and should not replace the standard 10 ft (3 m) of recommended clearance in all directions. Operating in tighter spaces may increase the risk of collision or serious bodily injury or damage during launch.

## Step 2 - Launch

Your drone will rotate 360° during launch to calibrate its Inertial Measurement Unit (IMU) and navigation system, climb to 10 ft (3 m), and hover.

### Option 1 - Drag the on-screen slider

The drone will initiate launching when you lift your finger away from the screen.

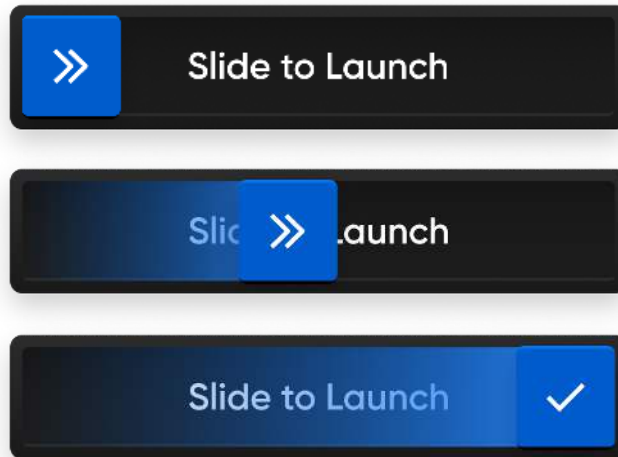

### Option 2 - Press and hold the Launch/Land button on the controller

The drone will initiate launching when you see the on-screen check mark.

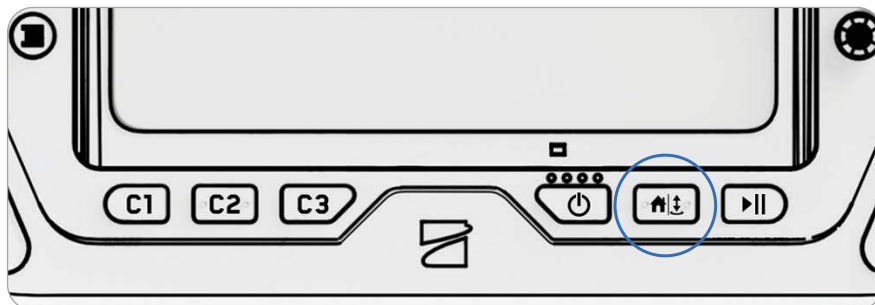

**NOTE:** If obstacle avoidance is enabled prior to launch, it will be active throughout the entire launch sequence.

# Inflight Operations | Launching

## Step 3 - Acquire GPS Lock

The GPS indicator in the telemetry bar will spin until the drone has acquired GPS Lock and established heading.

When the **Weak GPS Alt Limit** toggle is enabled, your drone will not be able to ascend above 164 ft (50 m) when GPS is weak.

Fly laterally to acquire a GPS lock.

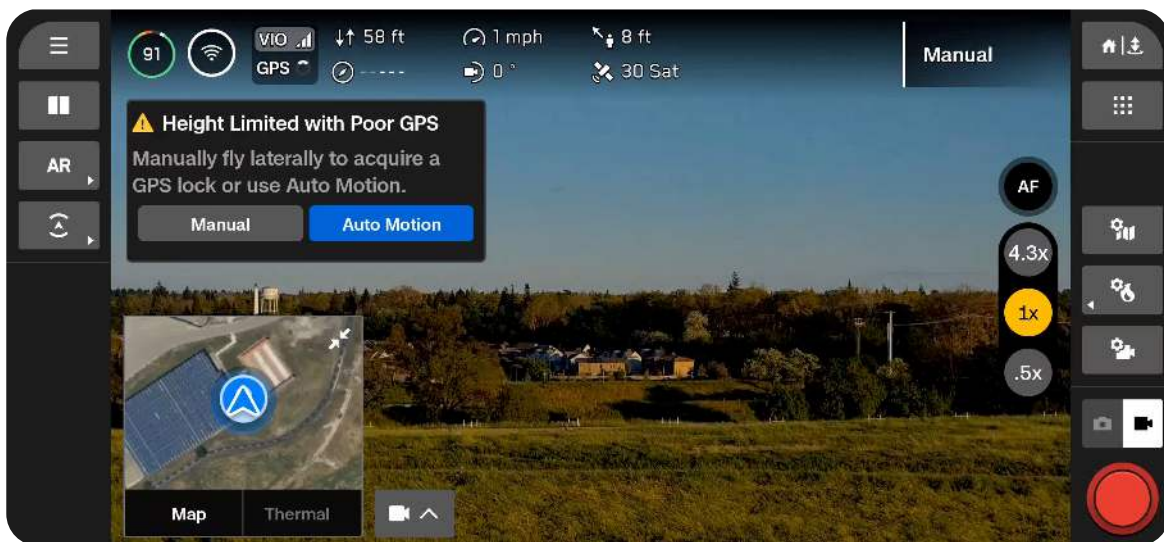

# Hand Launching

Launching and landing Skydio X10 from your hand is a quick and convenient way to start or end your flight, particularly if you are not in a clear, level area. For your safety, always use caution when hand launching. This maneuver is dangerous and should not be attempted in unstable environments, such as during high winds or while standing on a moving vehicle or boat.



**WARNING:** Obstacle avoidance is disabled when the drone is below 10 ft (3 m) during landing. Exercise extreme care to avoid injury or damage. Do not touch spinning propellers.

**Step 1 - Ensure you have clearance above and in front of you**

**Step 2 - Hold the drone away from you (sensor package facing away from your body)**

- Lightly grip the battery
- Keep the drone level, still, and at arm's length from your body
- Your fingers should be below the Skydio X10 chassis and away from the propellers at all times
- Ensure your hand steady

**Step 3 - Launch**

Press and hold the Launch Button on the X10 Controller. Slowly relax your grip as Skydio X10 launches.

- Do not push or throw the drone up in the air
- Keep your hand still - the drone will slide off your palm and take flight on its own



**TIP:** Quick Launch allows you to use the battery power button to hand launch your Skydio X10 so that you do not have to balance the controller in one hand and your drone in the other. Press the battery button four times to initiate the launch.

# Flight Screen

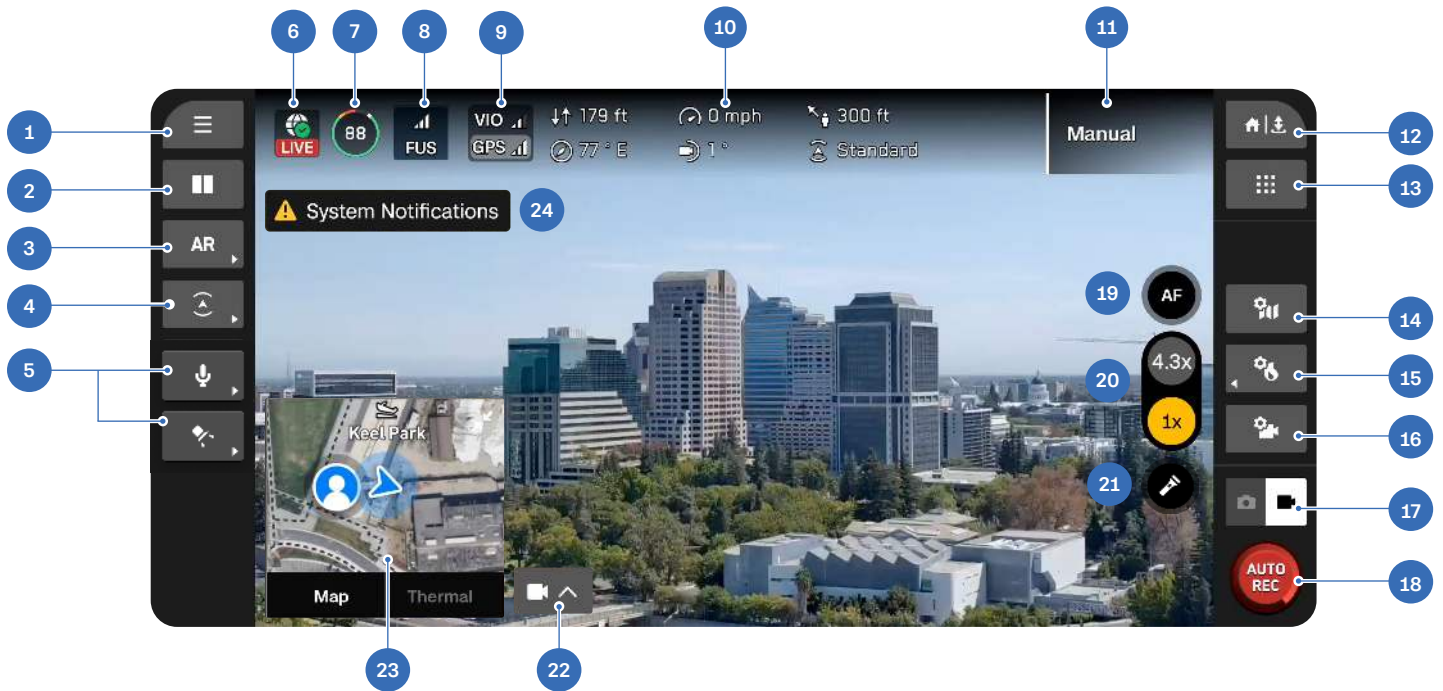

- |  |  |
|--|--|
| <ul style="list-style-type: none"> <li>1. Global Settings</li> <li>2. Display Layout</li> <li>3. AR Quick Actions</li> <li>4. Obstacle Avoidance Quick Actions</li> <li>5. Attachments Quick Actions*</li> <li>6. Controller Network Indicator</li> <li>7. Drone Battery</li> <li>8. Signal Strength (Connect Fusion, SL, 5G)</li> <li>9. Navigation Health Indicator</li> <li>10. Telemetry (customizable)</li> <li>11. Active Flight Skill</li> <li>12. Return/Land</li> </ul> | <ul style="list-style-type: none"> <li>13. Flight Skills</li> <li>14. Map Settings</li> <li>15. Thermal Settings</li> <li>16. Camera Settings</li> <li>17. Camera Mode</li> <li>18. Shutter</li> <li>19. Focus Control</li> <li>20. Zoom</li> <li>21. Flashlight On/Off (VT300-L/V100-L Only)</li> <li>22. View Selector</li> <li>23. Picture-in-Picture (PiP)</li> <li>24. Notifications</li> </ul> |
|--|--|

*\*Only appears when you are currently using an attachment.*

# Controller Network Indicator

This icon at the top of the screen indicates whether or not the Skydio X10 Controller has network connection (WiFi, cellular, or ethernet).

**Green check with a LIVE status** indicates a healthy network connection and an active stream with ReadyLink



**Green** check indicates a healthy network connection



**Red X** indicates no network connection



# Battery Indicator

The Battery Indicator **dynamically updates** during flight based on your altitude and distance from the return location. Monitor the indicator to understand how much battery is:

- Available for flight (green)
- Required to return (yellow)
- Required to land (red)

The battery on Skydio X10 has the ability to warm itself in cold environments. For more information, read the Maintenance section.

**Green** indicates the battery capacity for nominal flight before the time limit required to safely return and land.

- Decreases as battery capacity diminishes
- Adapts based on your altitude and distance from the return location

**Yellow** indicates how much battery is required to safely return.

- Adapts based on your altitude and distance from the return location

**Red** indicates how much battery is required to land.

- Adapts based on your altitude and distance from the return location



## Inflight Operations

---

The **lightning bolt** indicates the battery is connected and charging.



Three **dashes** indicate the battery is disconnected.

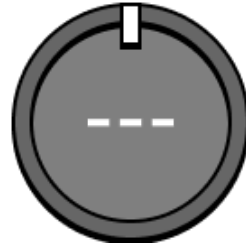

# Navigation Health Indicator



The Navigation Health Indicator (previously called VIO/GPS Indicator) provides insight into the:

- Navigation source of the drone
- Health of the drone positioning systems
- Reliability of the navigation source
- Current positioning system that is actively being used (highlighted)

This indicator helps you quickly assess whether the drone is relying on Visual Navigation (VIO) or GPS and take action if navigation quality degrades.

- **VIO** - Visual Inertial Odometry. This is the visual navigation system of the drone.
- **GPS** - Global Positioning System

If GPS is lost, Skydio X10 maintains continuous navigation using VIO, which operates alongside GPS and can fully take over all navigation functions.

The drone can maintain stable VIO at altitudes up to 984 ft (300 m).



**CAUTION:** Monitor your GPS and VIO health in the telemetry bar. If both VIO and GPS become unreliable, your drone will enter Attitude Mode.

# Inflight Operations

---

The source with a light gray background is the primary navigation source.

**White status bars** show whether or not VIO/GPS is stable or degraded.

- **One white bar** indicates a degraded state that may be close to failure, meaning you must fly with caution and ensure the other navigation source is in a healthy state
- **Zero bars** means the navigation source has failed and is relying completely on the backup source

**Yellow compass** indicates GPS is awaiting heading.

- If GPS heading hasn't converged yet, you will receive a notification prompting you to move the drone laterally to establish heading

**Yellow highlight** means your active navigation source is weak and your backup source is unavailable.

- If the highlighted source fails, the drone will enter **Attitude Mode** and you will have to manually fly



# Flight Skills

Skydio offers a range of manual and autonomous controls called **Flight Skills**. Select your desired skill and Skydio X10 will intelligently fly itself to assist with the task at hand.

By default, you will start in the Manual Flight Skill, which provides a traditional flying experience.

## Base Skydio Flight Skills

---

### Manual

Traditional flying experience. Obstacle avoidance settings will persist when flying manually, allowing Skydio X10 to route itself around obstacles, modifying any commands that could potentially cause a collision. Fly using Control Mode 1, Mode 2 (default), or Mode 3.

### Orbit Point

Rotate around a user-selected point-of-interest in either a clockwise or counter-clockwise direction, keeping the point in the center of the frame. Set a GPS position on a map.

### Shadow Track and Follow

Initiate tracking or following and Skydio X10 will autonomously maintain a consistent visual lock on people and vehicles, making it easier to track and capture critical details on moving subjects. Tracking in both Color and Thermal is available.

### Waypoints

Create and execute multi-waypoint GPS missions, preflight or postflight.



**INFO:** [Visit our website](#) for more information on additional Flight Skills available for purchase.

# Changing Flight Skills

## Step 1 - Select the Flight Skills icon



## Step 2 - Select your Flight Skill

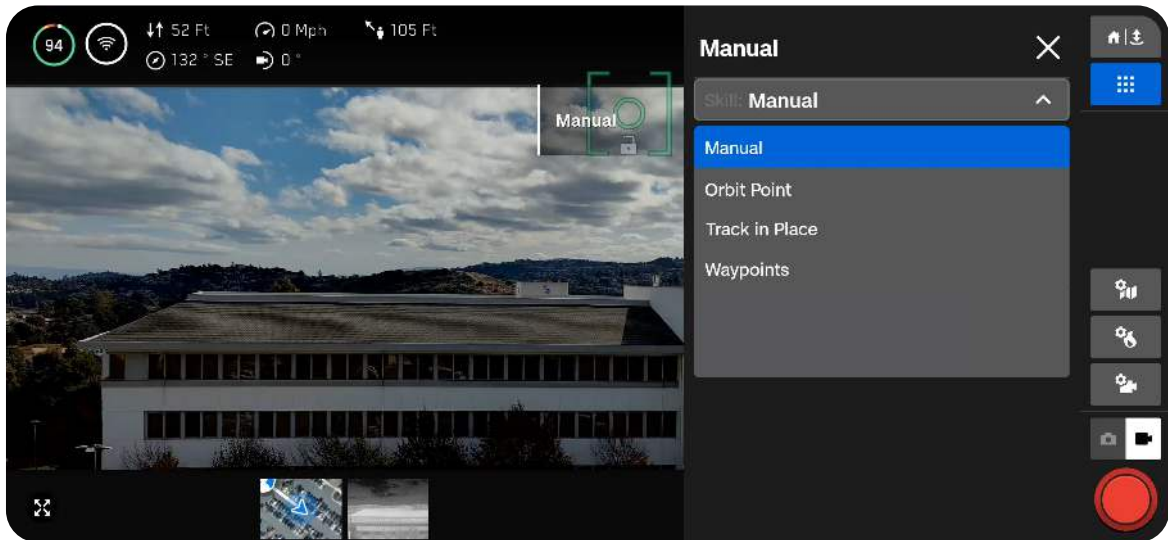

# Inflight Operations

## Step 3 - Adjust settings (optional)

Each skill may have its own adjustable settings which only affect the selected skill. If the selected skill has adjustable settings, they will appear below the skill name within the Flight Skills menu.

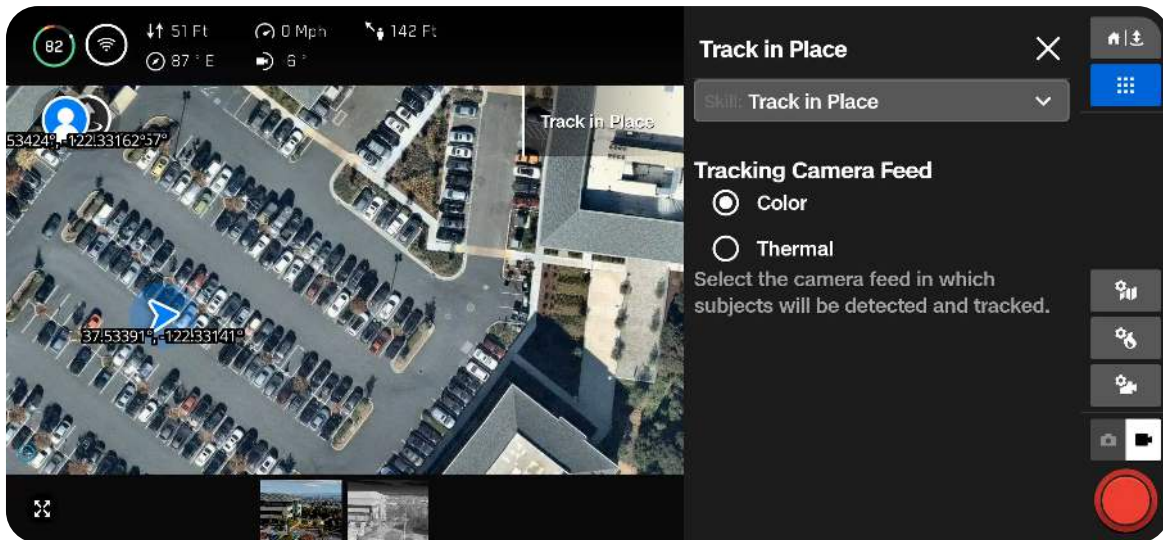

**NOTE:** To begin flying with the selected Flight Skill, you must first exit this menu.

# Skydio Shadow: Subject Track and Follow

Shadow Subject Track and Follow is an advanced autonomy capability that enables the drone to automatically track a selected person or vehicle and, when enabled, follow the subject's movement without continuous manual flight control.

- Supports incident response, perimeter monitoring, and other operations where maintaining persistent visual coverage is critical
- Easily track and capture critical details on moving subjects

Shadow Track and Follow consists of two related behaviors:

- **Shadow Track** - The drone autonomously identifies and maintains visual lock on a selected subject while managing camera framing and orientation
- **Shadow Follow** - Appears as an option to enable while tracking. When enabled, the drone adjusts its position, speed, and heading to maintain relative distance and orientation to the moving subject

# Operational Guidelines

- **The operator remains responsible for airspace awareness and safe operation at all times.**
- **Obstacle avoidance must be enabled to use Shadow Follow.** Follow behavior depends on obstacle avoidance for safe maneuvering. If a potential obstacle is detected, the drone may temporarily stop following and hold position while maintaining visual tracking.
  - If obstacle avoidance is disabled while flying with Follow, it will revert back to Shadow Track
- **Shadow Follow requires a minimum altitude of 60 ft AGL.** Below this altitude the drone continues to track, but does not reposition.
- Mode selection (Track or Follow) settings persist
- The system attempts predictive reacquisition for approximately 5 seconds when subjects move behind buildings, vegetation, or vehicles. Extended occlusions may result in tracking loss.
- Any manual adjustment (forward, back, lateral, or altitude) orbits the subject and resets the position that Follow will maintain.

# Known Limitations

- Follow is not available if obstacle avoidance is OFF.
- Tracking performance may degrade when:
  - In low light environments without the NightSense attachment.
  - Using thermal.
  - A subject changes posture significantly, such as crouching or kneeling. The green tracking box may shift or temporarily lose lock while the system re-identifies the subject.
- Shadow can reidentify a lost track in 3-5 seconds assuming the subject continues moving at a roughly constant velocity. Shadow may mistakenly jump tracks during this time if it sees a similar subject.
- Subject Tracking cannot operate concurrently with VPS-dependent modes or 3D Scan due to system resource load.

# Shadow Follow Altitude and Distance Behavior

When Follow is enabled, the drone maintains a **relative position** to the subject based on where Follow was initiated.

- The drone attempts to maintain the same AGL height from the moment Follow begins. If the Pilot wants to follow from a higher or lower altitude, they can manually reposition the drone, and Follow will continue from the new height. Manual repositioning (forward, back, lateral, or altitude) updates the relative viewing position that Follow maintains.
- There is no fixed standoff distance. Follow maintains the viewing distance the drone had at initiation.
  - The drone will not move farther from the subject than the viewing angle and distance established when Follow begins.
  - The drone will not move closer than an elevation angle of  $\sim 75^\circ$ . If the subject moves toward the drone, the drone will hold position until the distance becomes unsafe or too close.



**NOTE:** Standoff Distance settings only apply to Custom Markers, not Shadow Follow.

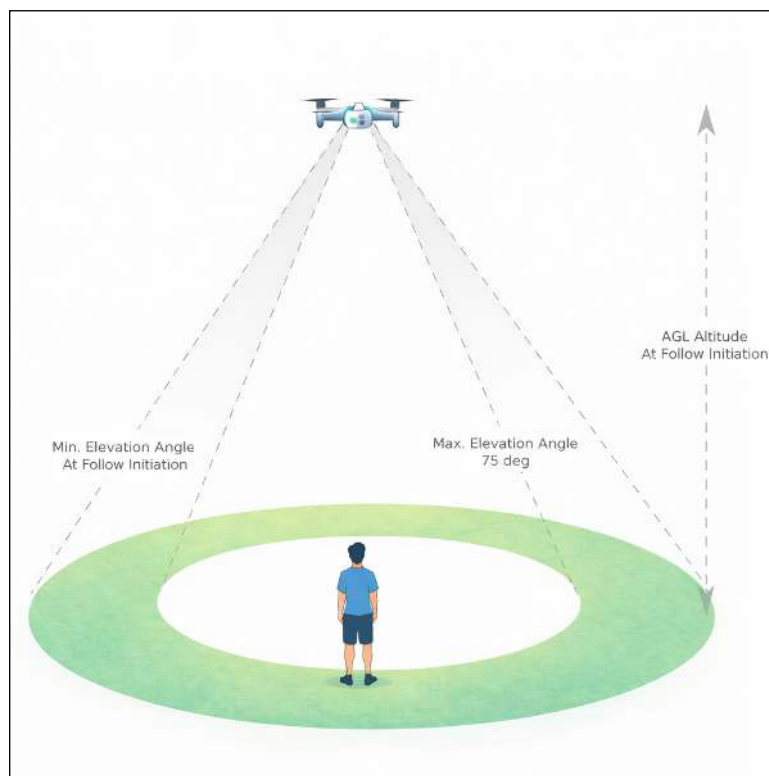

## How to use Shadow Track and Follow

### Step 1 - Select the Flight Skills icon

### Step 2 - Select Subject Track

Select the Color or Thermal camera feed. If you would like to immediately begin following the subject, enable the toggle **Start in Follow**.

While flying in the Subject Track skill, a detection icon (car or person) appears in the video feed as you fly over people or vehicles available to track.

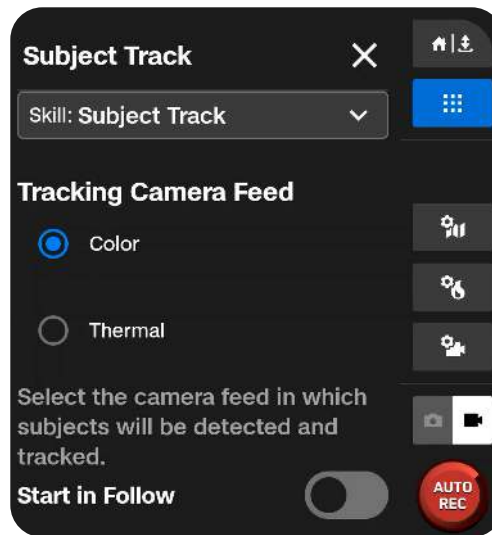

### Step 3 - Select the icon to lock onto a subject and begin tracking

Once tracking begins, the icon turns into a green box over the tracked subject.

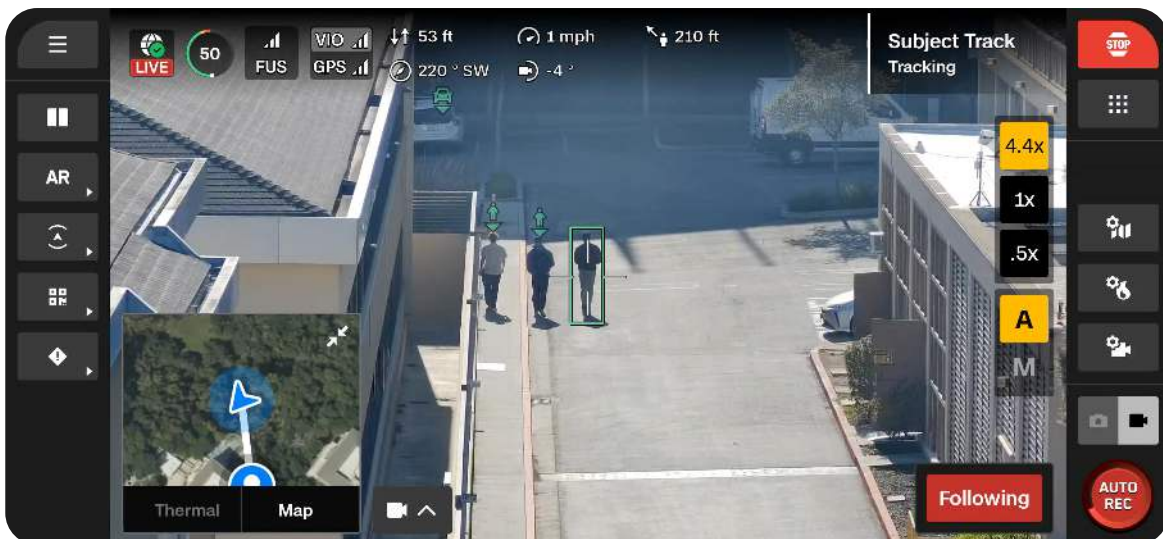

### Step 4 - Optionally switch into Follow mode

You will see a blue **Follow** button in the bottom right of the screen. Select this button to enable following. While actively following a subject, the button in the corner will turn into a red box that says, **Following**.

- **Track** - the gimbal remains locked on the subject while the Pilot flies manually
- **Follow** - the drone locks the gimbal and autonomously follows the subject

### Best Practices

To maintain reliable tracking performance and reduce the likelihood of interruptions or tracking loss, Remote Pilots should review the best practices below during Shadow Track and Follow operations:

#### Anticipate Obstructions

- Assess the subject's likely path and identify buildings, vehicles, or other structures that may interfere with line-of-sight.
- Adjust the drone's position early to maintain an unobstructed view, which may require flying closer to the subject or repositioning laterally to avoid occlusion.

#### Utilize Zoom Capabilities

- If the subject is clearly visible in the camera feed without the operator straining to identify it, the tracking model will generally be able to detect and maintain the lock.
- Excessive distance or reliance on extremely small visual targets may reduce tracking performance.

#### Avoid Overhead Viewing Angles

- Subjects, particularly people, are more difficult for the system to identify or re-identify when viewed directly from above.
- Maintaining an oblique viewing angle improves tracking continuity and reduces the likelihood of subject confusion in complex environments.

# Dispatch: Viewing and Responding to Incidents (DFR Command)

**Incident Markers** are visual indicators on the Map View that represent active or past incidents. Each marker displays essential details such as:

- **Status** - Open, Drone Responding, or Closed
- **Timestamp** - Time of the initial report
- **Location** - Address

The **Incident List** allows Pilots to look at all current Incidents from the organization's integrated Computer-Aided Dispatch (CAD) system, NextGen911 integrations, or custom Incidents created in Remote Flight Deck.



**NOTE:** Incidents that are older than one hour do not populate.

To view the Incident List, either:

- Select an Incident Marker on the map
- Select the Dispatch Quick Action button

# Inflight Operations

Within the Incident List, Pilots can:

- Expand or collapse the menus to view Open, Drone Responding, and Closed incidents
- Search Incidents
- Use the Filter icon to filter by time or area
- Sort by created time, modified time, or closest to drone

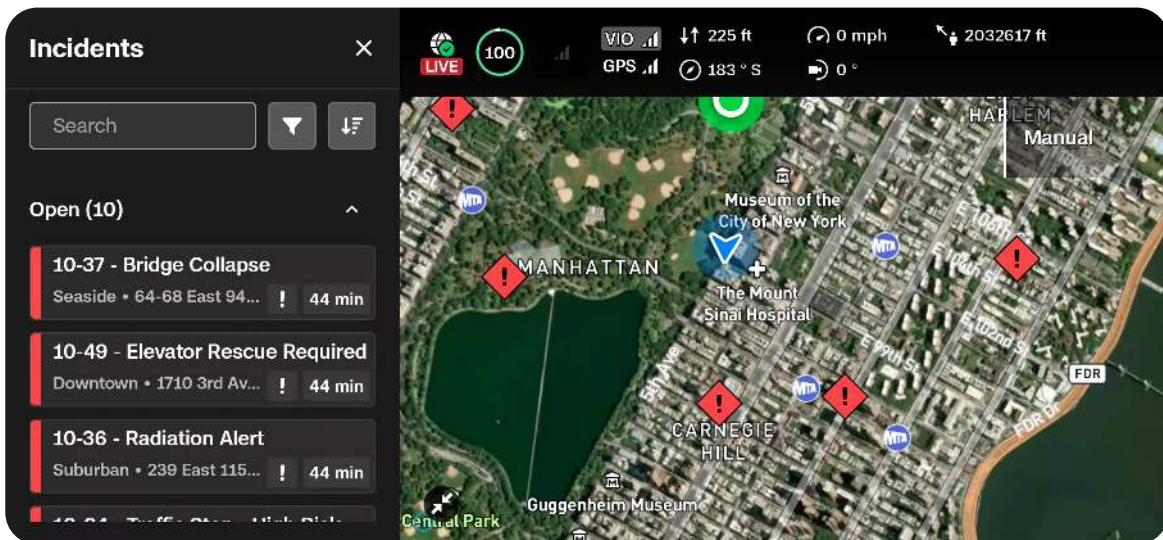
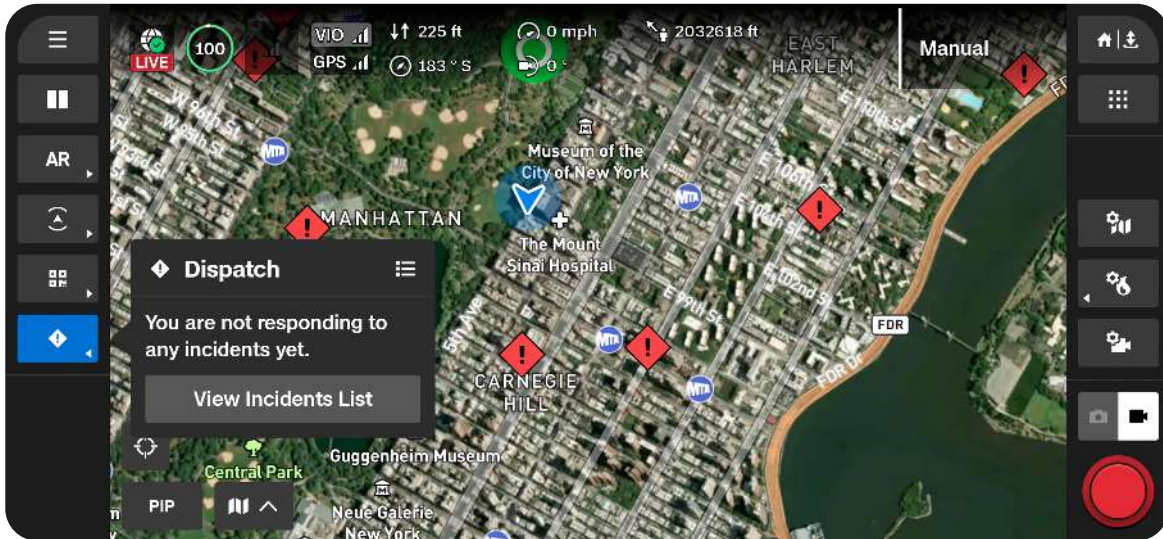

## Responding to an Incident

**Step 1 - Select an Incident on the map or via the Incident List**

**Step 2 - Revise the status and select the blue Respond button**

Use the drop-down menu to update the Incident to a **Drone Responding** state. The drone will automatically fly to the incident location. While in transit, you can view a snapshot of the Incident details by selecting the **Dispatch Quick Action**.

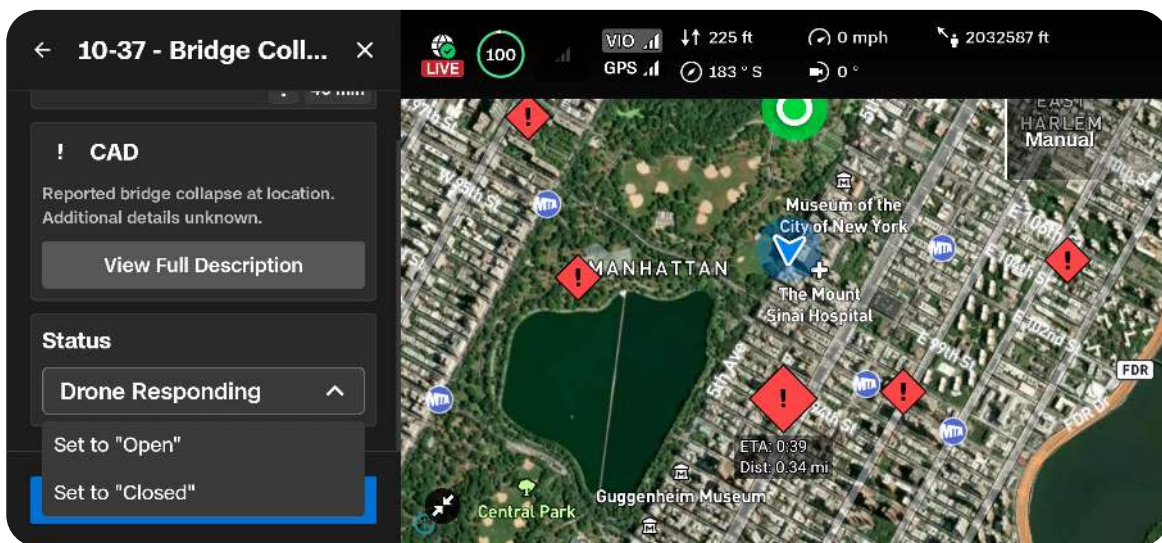

**Step 3 - Close the Incident**

When response to an Incident completes, use the drop-down menu to update the status to **Closed**. Closing an incident will remove it from the list of Active or Open Incidents, indicate to other pilots that a drone response has occurred, and move it to a Closed section.

Follow your organization's SOP for completing an incident response.

# Flying at Night



**WARNING:** *Obstacle avoidance is disabled in Low Light mode without NightSense. Fly with extreme caution!*

## Flying at Night without the NightSense Attachment

When flying at night or in low light conditions without NightSense, Skydio X10 will primarily use GPS to navigate and obstacle avoidance will be disabled.

When launching from the ground in GPS mode at night, a hand-wave calibration is not required. Skydio X10 will use magnetometer-based heading estimation when Visual Inertial Odometry (VIO) is unavailable (e.g., night conditions, low-texture areas, or during GPS-only operations). The drone determines heading during its normal 360° launch spin using compass and GPS data.



**NOTE:** *Using Hand Launch in GPS mode requires hand wave calibration.*

# Inflight Operations

## Step 1 - Enable Low Light mode

You will see an on-screen notification to enable Low Light mode if there is insufficient light. You may also select the Global Settings icon, select Sensing, then select Low Light.

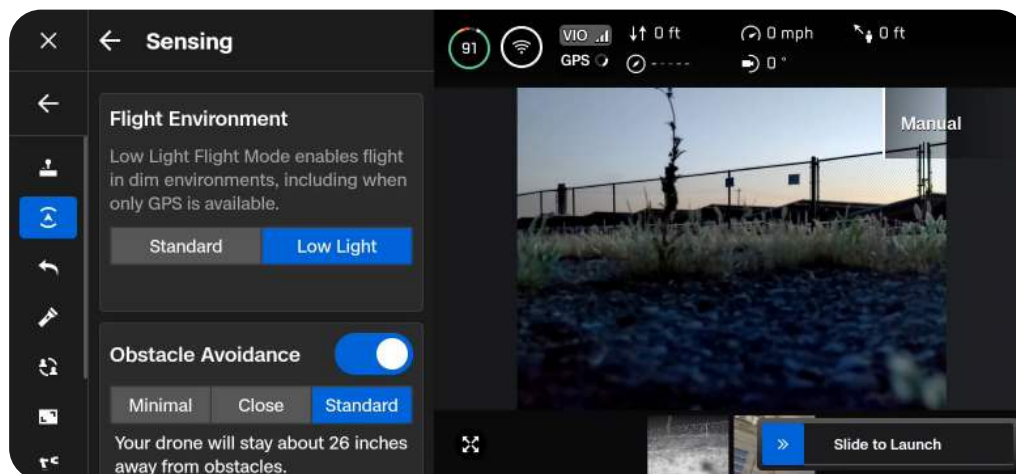
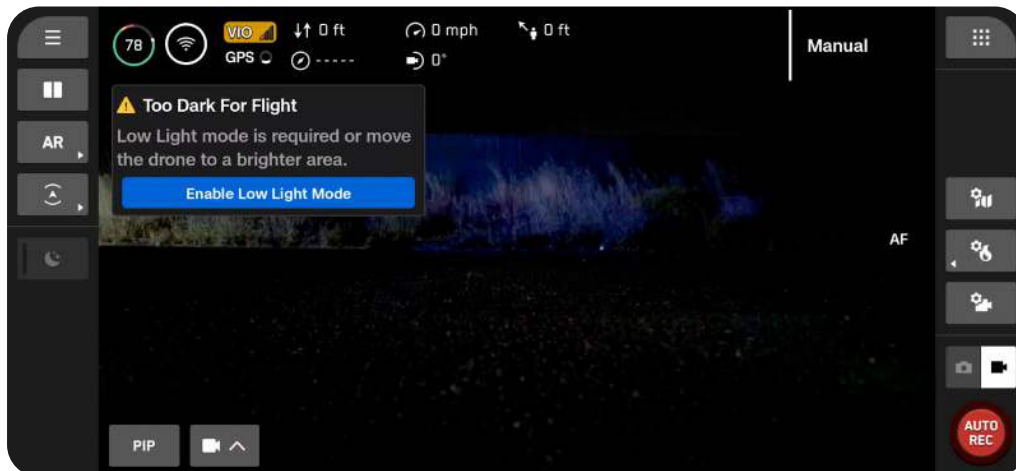

## Inflight Operations

---

### Step 2 - Configure your lighting settings



**WARNING:** Do not use artificial lighting to brighten the launch or landing zone during night flights. Enhancing illumination in a localized area, such as using vehicle headlights, can cause the drone to misinterpret ambient lighting conditions. This may result in a sudden transition to Attitude Mode after launching, increasing the risk of drift and loss of control. For safe night operations, follow best practices for low-light flight and ensure the drone is prepared for consistent lighting conditions throughout the mission.

Improve visibility by enabling infrared or visible strobe lights. Select **Lighting** then toggle on RGB (default navigation lights), Infrared, or Strobe lights. Infrared and Strobe lights cannot be on at the same time.

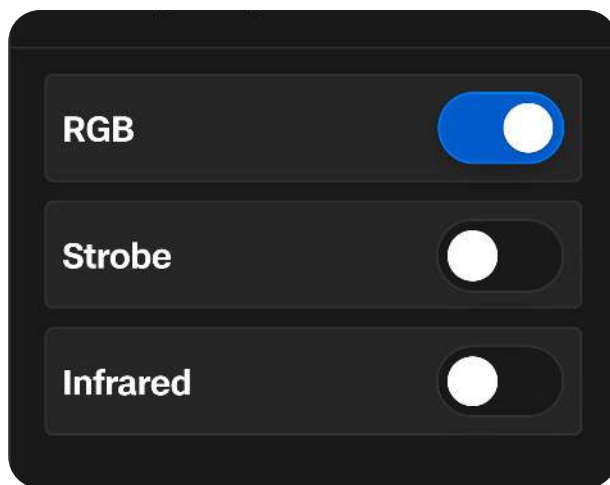

# Inflight Operations

## Step 3 - Calibrate if required

Launching from the ground in GPS mode during night launches does **not** require a hand wave calibration.

If you are performing a hand launch, calibration is required.

- Follow the on-screen calibration instructions
- Hold your drone from the bottom with the camera facing away from your body and wave from side to side to calibrate
- You will see an onscreen message when calibration is complete

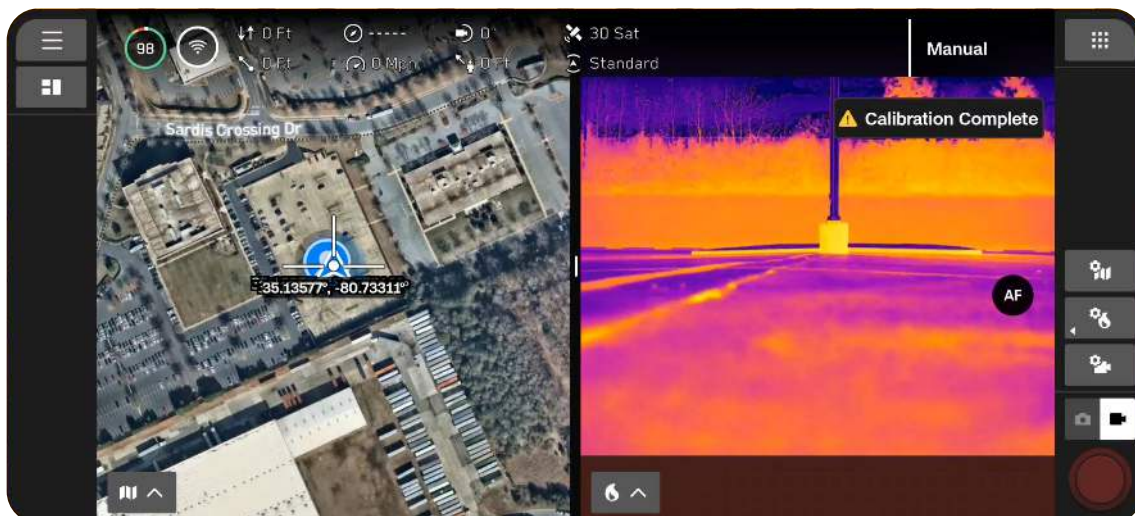
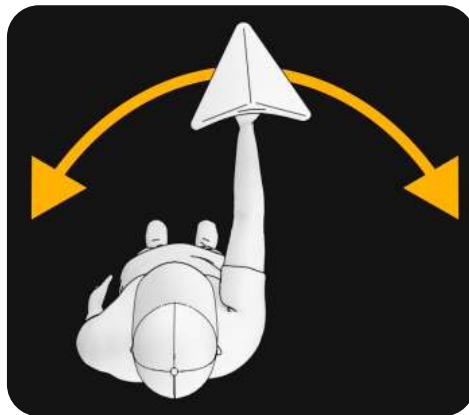

## Inflight Operations

---

### Step 4 - Launch Skydio X10

Your drone will rotate 360° during launch to calibrate its Inertial Measurement Unit (IMU) climb to 10 ft (3 m), and hover. Obstacle avoidance will be disabled.

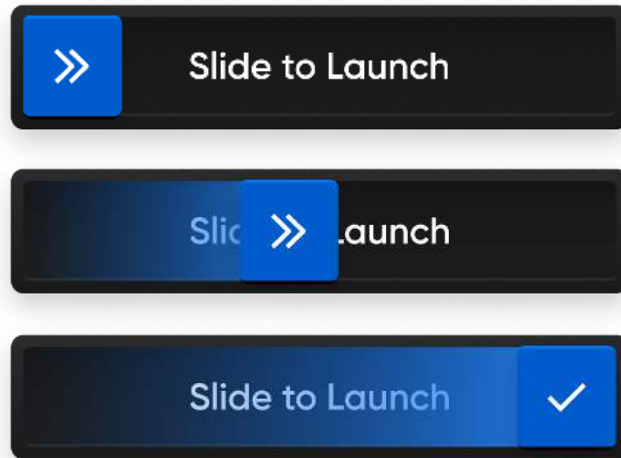

# Flying at Night with the NightSense Attachment

The Skydio NightSense attachments and add-on software allow you to leverage Skydio X10 visual navigation and obstacle avoidance capabilities even when flying at night.

The set of two NightSense attachments cast a light above and below your drone. This light illuminates the area, unlocking Skydio visual navigation and obstacle avoidance when flying at night and in low-light conditions.



### **KEY WARNINGS:**

- *After prolonged use of the NightSense attachments, they may be hot to the touch and could burn your hand. After landing, wait for your attachments to cool down before handling.*
- *Do not stare directly into your NightSense modules at close range. NightSense attachments, both Visible and Infrared, may cause eye damage if held closer than an arm's reach for 30 seconds or more.*
- *Due to potential burn risk and eye damage, Skydio does not recommend Hand Landing your drone while using NightSense.*

## Step 1 - Install your attachments

Visit [Getting Started with NightSense for Skydio X10](#) for step-by-step installation instructions.

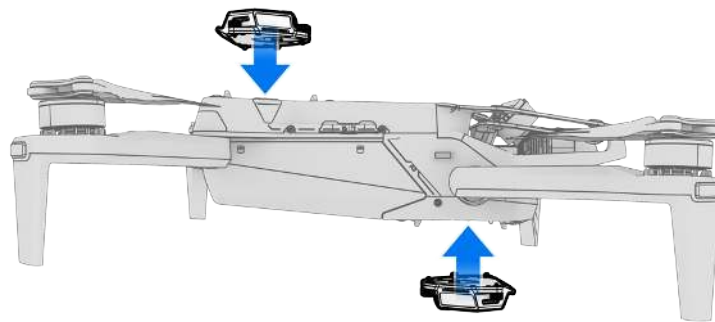

# Inflight Operations

## Step 2 - Enable Low Light mode

You will see an on-screen notification to enable Low Light mode if there is insufficient light. You may also select the Global Settings icon, select Sensing, then select Low Light.

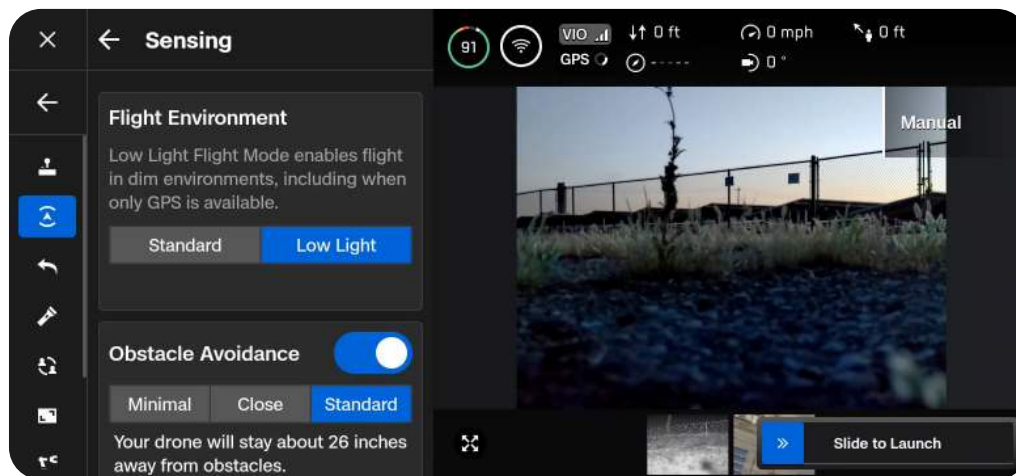
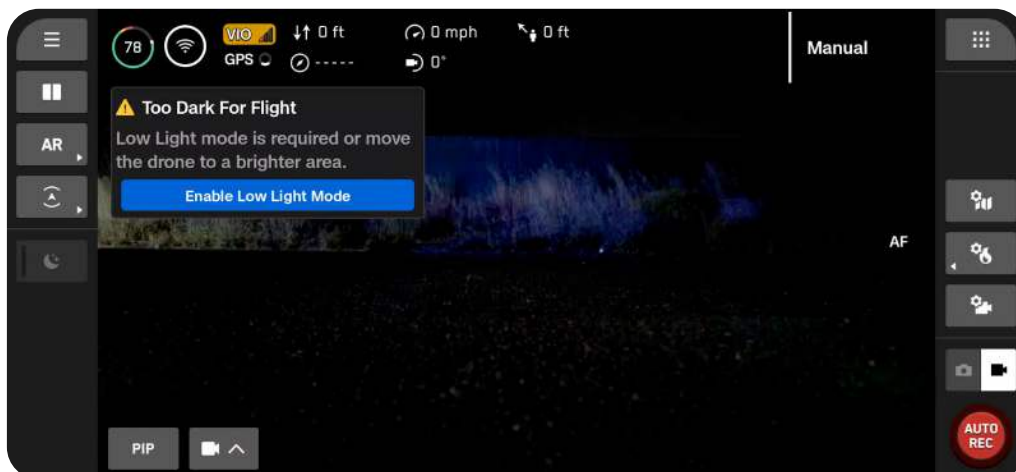

## Inflight Operations

---

### Step 3 - Configure your lighting settings

Improve visibility by enabling infrared or visible strobe lights. Select Lighting then toggle on RGB (default navigation lights), Infrared, or Strobe lights. Infrared and Strobe lights cannot be on at the same time.

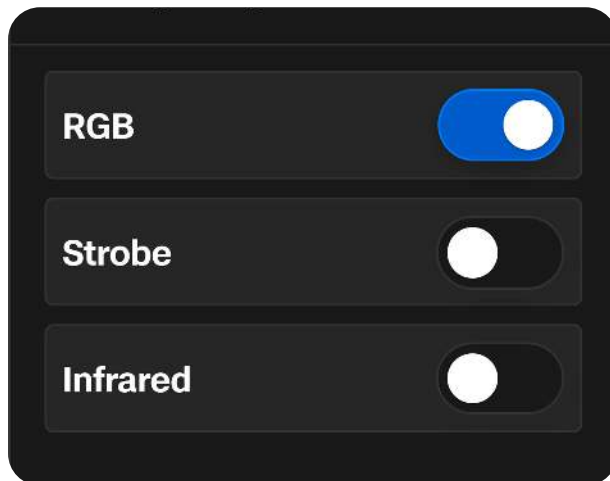

**WARNING:** Do not use artificial lighting to brighten the launch or landing zone during night flights. Enhancing illumination in a localized area, such as using vehicle headlights, can cause the drone to misinterpret ambient lighting conditions. This may result in a sudden transition to Attitude Mode after launching, increasing the risk of drift and loss of control. For safe night operations, follow best practices for low-light flight and ensure the drone is prepared for consistent lighting conditions throughout the mission.

# Inflight Operations

## Step 4 - Enable NightSense

By default, NightSense will automatically turn on when entering Low Light mode. Use the left sidebar quick action to subsequently turn NightSense on or off. The visible or infrared lights from the NightSense attachments will illuminate the area around the drone.

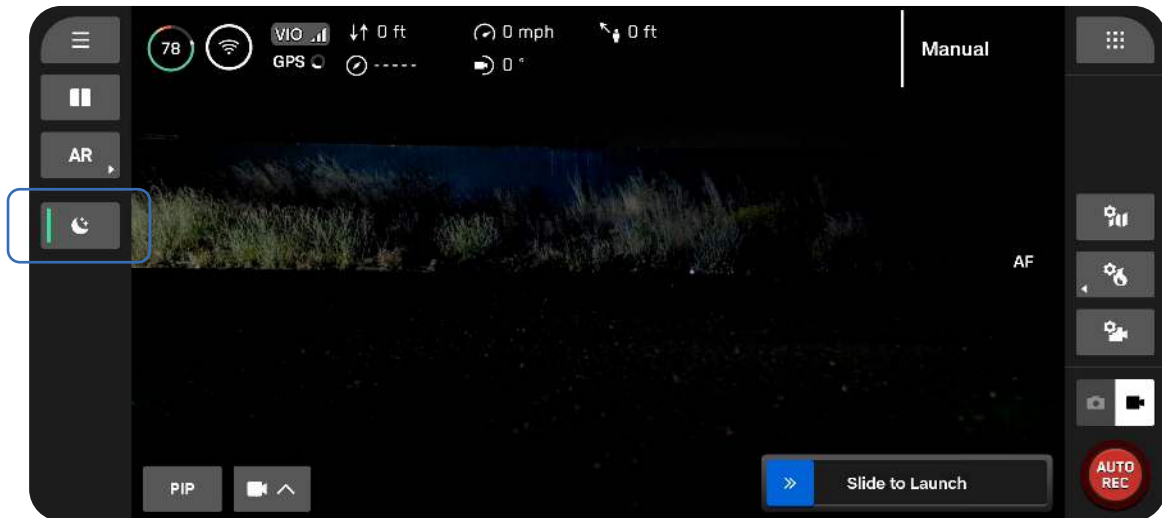

## Inflight Operations

---

### Step 5 - Launch Skydio X10

Your drone will rotate 360° during launch to calibrate its Inertial Measurement Unit (IMU) climb to 10 ft (3 m), and hover.

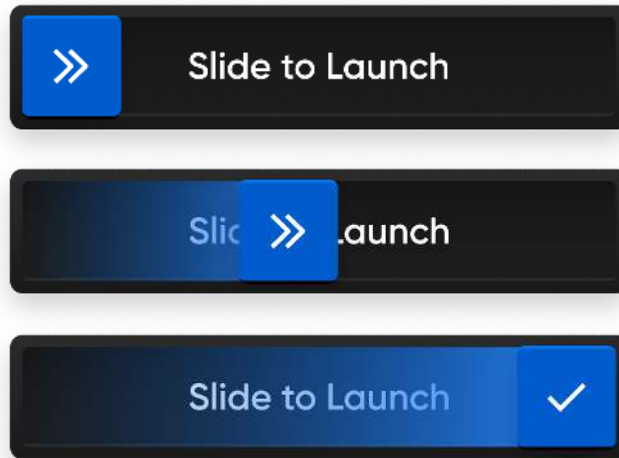

**NOTE:** Skydio X10 is limited to a max speed of 18 mph (8 m/s) with NightSense on, unless actively flying to a Fly Here Now location (Fly Here Now speed is 45 mph).



**INFO:** For more information about flying with NightSense, including configuring settings visit: [Getting Started with NightSense for Skydio X10](#).

### Inflight Safety Considerations



**WARNING:** Due to potential burn risk and eye damage, Skydio does not recommend Hand Landing your drone while using NightSense.

#### Obstacle Avoidance

- **NightSense ON:** Obstacle avoidance is active when NightSense is on. Enable the AR Depth View (via the **AR Quick Action**) to visually display where Skydio X10 detects obstacles in the environment, especially when using Infrared NightSense attachments, to assist with situational awareness.
- **NightSense OFF:** When in Low Light mode, obstacle avoidance is disabled. Take extra caution when piloting the drone to avoid obstacles and stay clear of people.

#### GPS Signal

- **NightSense ON:** When NightSense is on, visual navigation (VIO) is the primary navigation method, however if flying at high altitudes the drone will rely on GPS. Monitor your VIO and GPS health status inflight; if both VIO and GPS quality degrade the drone will enter Attitude Mode.
- **NightSense OFF:** Maintaining a strong GPS signal is paramount when operating X10 at night. If Skydio X10 loses GPS while in Low Light mode, and there is not enough ambient light for VIO, it will enter Attitude Mode.

#### Visibility

Improve visibility by enabling infrared or visible strobe lights. Skydio X10 strobe lights meet the FAA requirement of being visible at a distance of 3 statute miles.

#### Return Behavior

Review the return behavior height setting in the Global Settings menu.

**NightSense OFF:** Skydio X10 does not avoid obstacles when in Low Light mode and NightSense off, so you may want to set the drone's return height such that it will be above any potential obstacles.

#### Landing

When landing, use the controller joystick to descend down to 15 feet (4.6 meters), when you are ready to land, press and hold the LAND button on the screen or the controller. Do not hand launch or hand land at night.

# Flying in Precipitation

Skydio X10 is IP55 rated and able to fly in light to moderate precipitation when **obstacle avoidance** is disabled. Skydio will primarily use GPS to navigate, so it is critical to have a strong GPS signal when flying in precipitation.



**CAUTION:** *Flight in icing and/or lightning conditions is not supported and may result in the loss of your drone.*

## Quick Reference

### Flying in precipitation during the day

- Select Standard as your Flight Environment
- Disable obstacle avoidance via the quick action or the settings menu
- Only fly with a strong GPS signal

---

### Flying in precipitation at night

- Select Low Light as your Flight Environment
  - Disable obstacle avoidance, disable NightSense (if you have NightSense attachments installed)
  - Only fly with a strong GPS signal
-

## Preflight

Step 1 - Ensure all rubber seals on the drone are securely closed

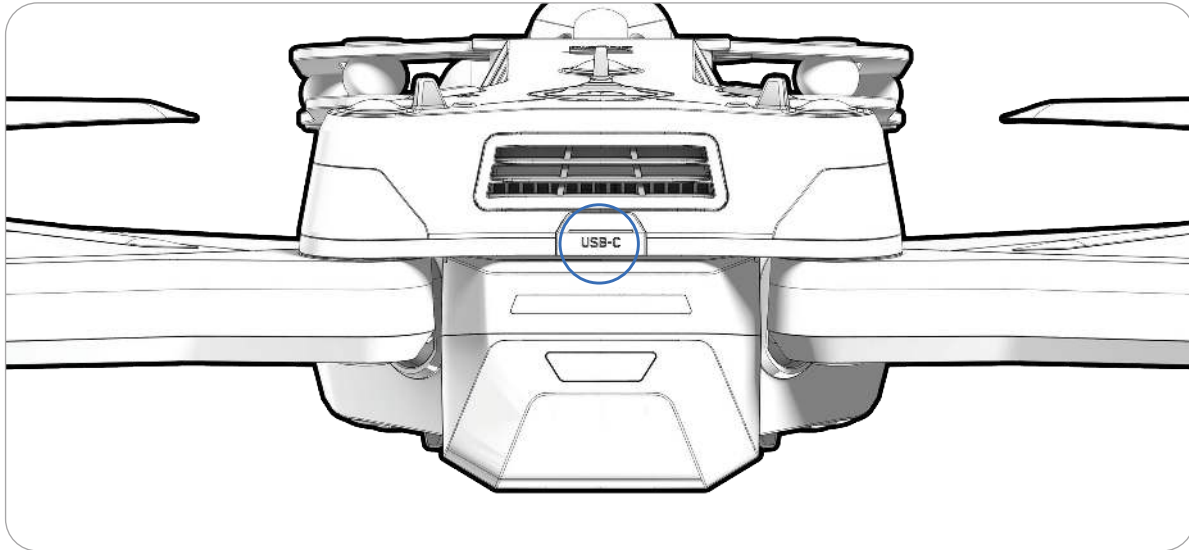

Step 2 - Select your Flight Environment

Select the Global Settings icon, select Sensing, then select Standard (flying in precipitation during the day) or Low Light (flying in precipitation at night).

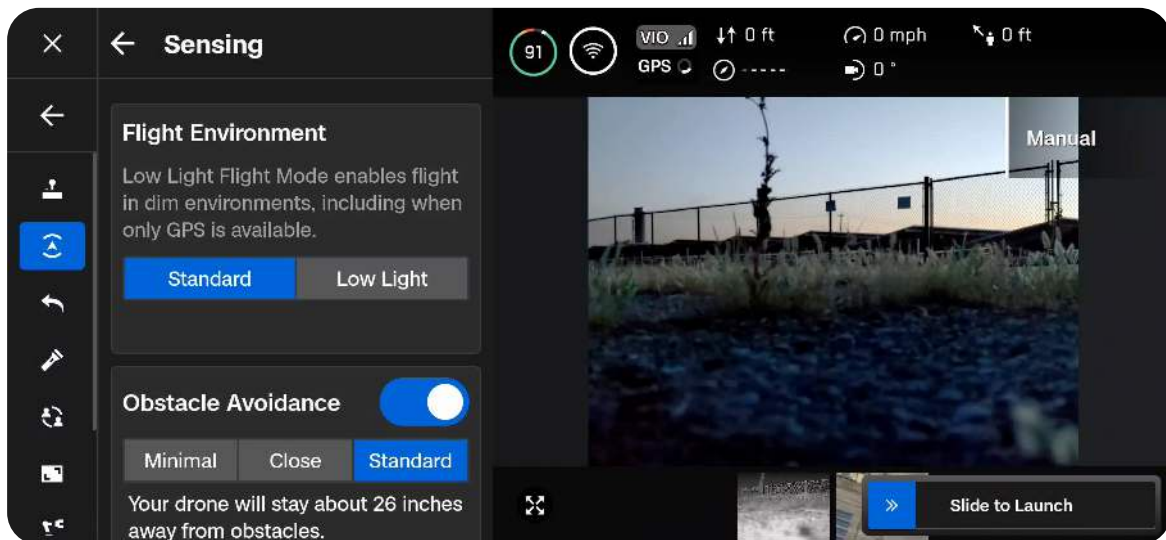

# Inflight Operations

## Step 3 - Calibrate your drone (if in Low Light mode)

Exit the Global Settings menu, then select Fly Now. Turn off NightSense (if on). Hold your drone from the bottom with the camera facing away from your body and wave from side to side in a straight line to calibrate. You will see an on-screen message when calibration is complete.

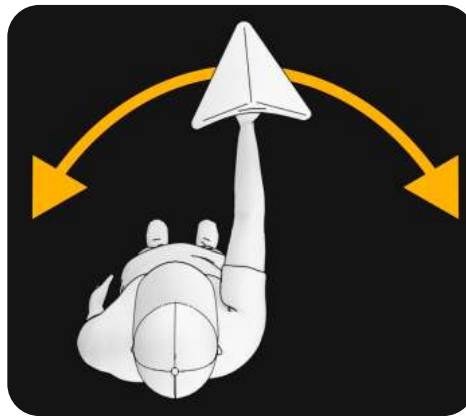
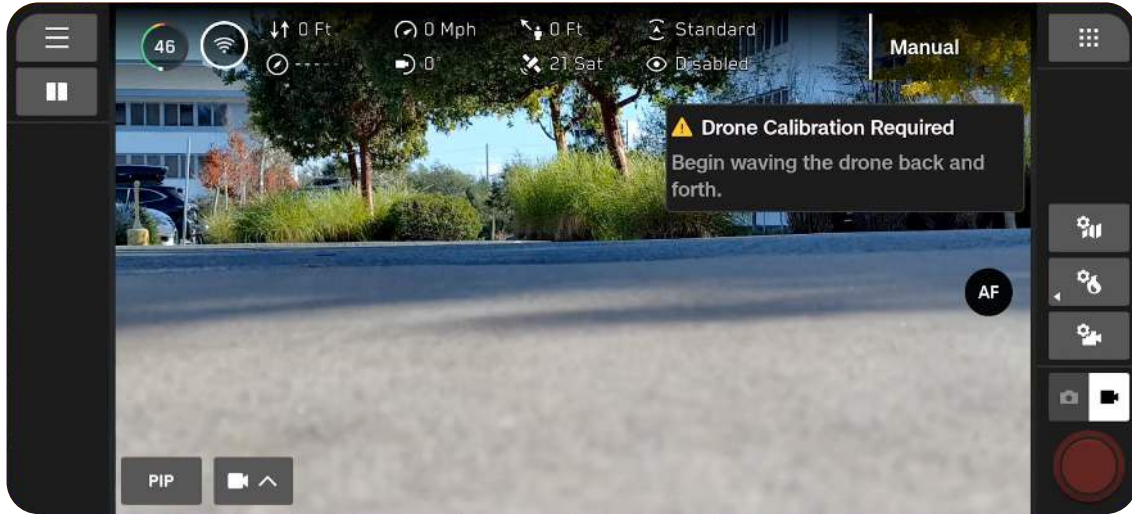

# Inflight Operations

## Step 4 - Disable obstacle avoidance

Disable obstacle avoidance from the quick action menu on the Flight Screen. Turn off NightSense if on.

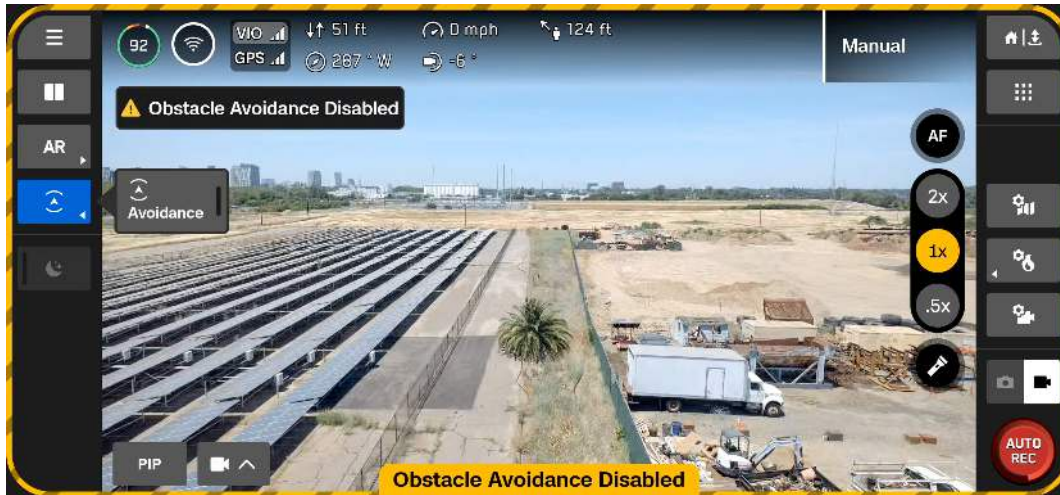

**NOTE:** If it begins to precipitate during a flight, disable obstacle avoidance inflight.

## Step 4 - Launch Skydio X10

Your drone will rotate 360° during launch to calibrate its Inertial Measurement Unit (IMU) climb to 10 ft (3 m), and hover. Obstacle avoidance will be disabled.

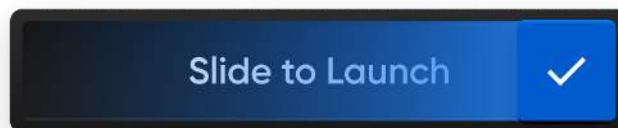
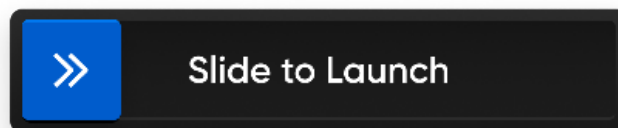

## Inflight Operations

---

### Step 5 - Lock controller touchscreen (optional)

To prevent touchscreen interference from precipitation, you have the ability to lock all touchscreen inputs. While holding the back button, press the D-pad down to lock or unlock the screen.

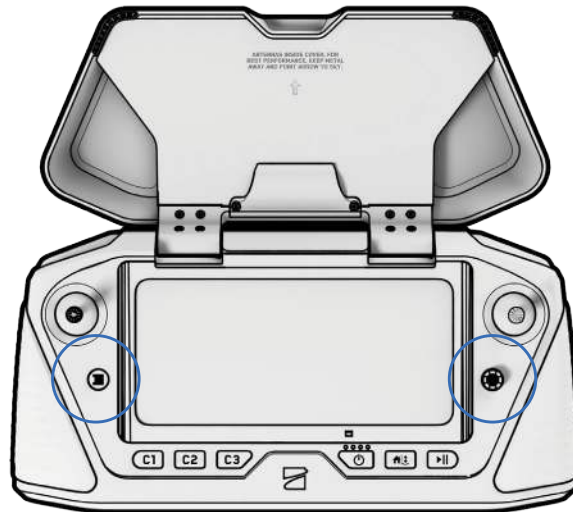

**NOTE:** You will not be able to make on-screen selections while touchscreen inputs are locked. Controller buttons are still functional and can be customized to perform specific actions (Controls > Input Mapping).

# Inflight Safety Considerations

### **Obstacle Avoidance**

When flying in precipitation, obstacle avoidance must be disabled. Take extra caution when piloting the drone to avoid obstacles and stay clear of people.

### **GPS Signal**

Maintaining a strong GPS signal is paramount when flying in precipitation, since Skydio X10 is navigating primarily using GPS. If Skydio X10 loses GPS, it will enter Attitude Mode.

### **Visibility**

Improve visibility by enabling infrared or visible strobe lights. Skydio X10 visible strobe lights meet the FAA requirement of being visible at a distance of 3 statute miles.

### **Wireless Range**

Moisture in the air may significantly reduce wireless range.

### **Return Behavior**

Review the return behavior height setting in the Global Settings menu. Obstacle avoidance must be disabled when flying in precipitation, so you may want to set the drone's return height such that it will be above any potential obstacles.

### **Landing**

When landing, use the controller joystick to descend down to 15 feet (4.6 meters), when you are ready to land, press and hold the LAND button on the screen or the controller. Do not hand launch or hand land in precipitation.

## Postflight

After flight operations in precipitation, follow all postflight steps before stowing your drone to ensure it is properly maintained and does not sustain any water damage.



**CAUTION:** Do not stow Skydio X10 while wet.

### Step 1 - Power off Skydio X10

### Step 2 - Allow water to drain

Install the gimbal stabilizer clip to hold the sensor package in place. Rotate the drone to allow water to drip out of all egress areas.

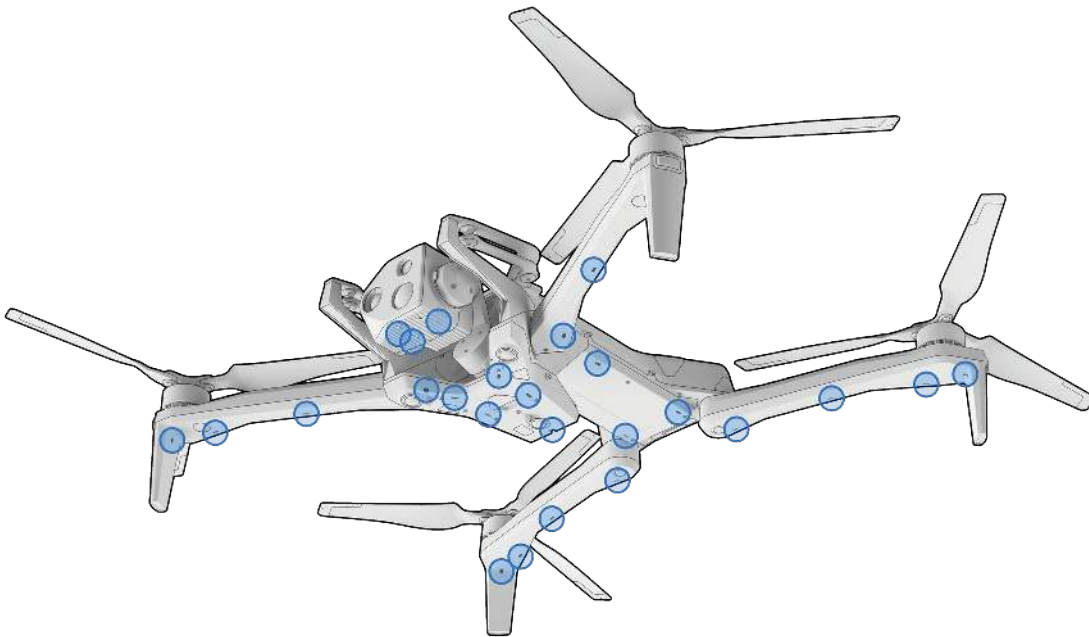

**NOTE:** Skydio is IP55 rated and able to fly in light to moderate precipitation. It is expected for water to enter different areas of the drone and draining postflight is normal. Sensitive components are protected.

## Inflight Operations

---

### Step 3 - Remove the battery



### Step 4 - Wipe camera lenses clean

Use a microfiber cleaning cloth to wipe the lenses clean and prevent dried water spots from forming.

## Inflight Operations

---

### Step 5 - Air dry for a minimum of 12 hours

Leave the drone to air dry in a ventilated, temp-controlled environment with the arms deployed in an upright position. Do not open any seals, including the USB-C charge port, until after the drone is dry. Do not remove the sensor package or any attachments while the drone is wet.

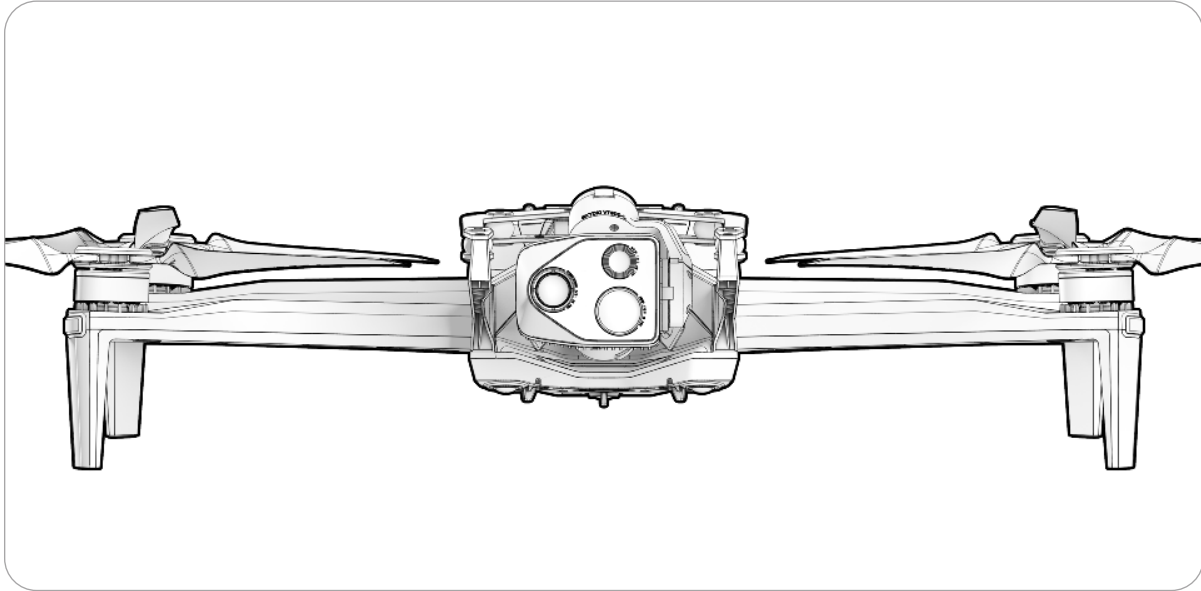

# Icing Detection Alerts



**CAUTION:** Flight in icing and/or lightning conditions is not supported and may result in the loss of your drone.



**NOTE:** Icing detection provides an early warning but does not automatically return or land the drone.

Cold, wet conditions can cause ice to form on rotor blades, reducing lift and flight stability. **Vehicle Icing Detection** is a critical safety feature that helps prevent incidents during cold and wet conditions by automatically identifying early signs of icing and alerting you before performance is affected.

The Flight System monitors inflight performance for signs of reduced lift or increased drag that may indicate ice forming on the drone. If icing is detected, Pilots will receive an alert, enabling early corrective action before flight performance degrades.

- Icing alerts may appear in temperatures up to 46°F (8°C)
- When this alert appears, Pilots should safely and promptly land and discontinue flight operations until conditions improve

# Low Battery



**WARNING:** You may choose to cancel an automated landing or delay your return when the Return Battery capacity has been reached at your own risk – you are solely responsible for the potential loss of the drone and/or any serious bodily harm and property damage that may result.

The **Battery Indicator dynamically updates** during flight based on your altitude and distance from the return location. Monitor the indicator while flying to understand how much battery is:

- Available for flight
- Required for return
- Required to land

Skydio X10 will assess the altitude and distance from the Launch or Home Point and alert you when it is time to return and land. It is **strongly recommended you initiate a return or land at this time.**

### Skydio X10

You will receive a series of notifications alerting you about the current status of the drone battery:

#### Return Battery Capacity Reached

The drone only has enough battery to return and land. This is based on conditions such as weather or attachment usage. **If you delay your return, you may not have sufficient battery power to reach the return point.**

- An audible beep will play over the X10 Controller
- If the drone is within 32 ft (10 m) of the return location, it will begin returning without displaying this notification
- If you selected **Ask to Return (default)** in your **Return** settings, you will be prompted to choose **Return** or **Keep Flying**
- If you selected **Auto Return on Low Battery** in your **Return** settings, the drone will begin returning automatically when this notification appears; if you select **OK**, it dismisses the notification but does **not** cancel the return
- If no Home Point is set, the drone will return to the Launch Point



*Ask to Return (default)*

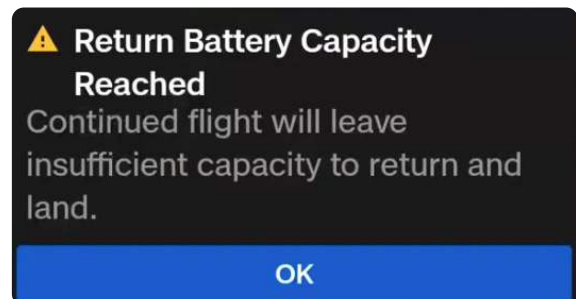

*Auto Return on Low Battery*

### Land Soon

The drone will continue flying, but this notification alerts you one minute before the drone will begin to land in place. Autonomous actions, such as Waypoints, 3D Scan, or Subject Tracking, are disabled. **You may choose to continue flying, however, it is strongly recommended that you fly to a safe location and land soon.**

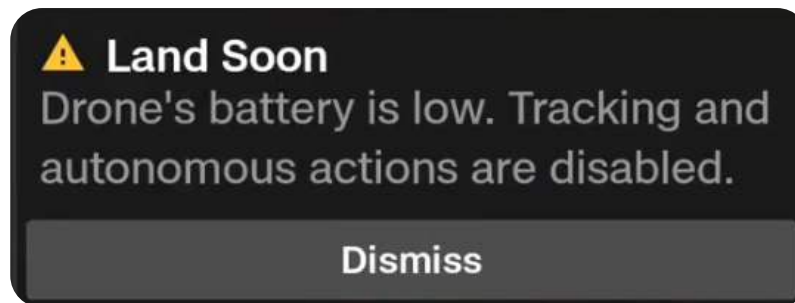

### Drone Battery Low

The battery level is too low to continue flying and the drone will begin looking for a clear and flat landing surface. The drone will land in place and may make minor adjustments to land in the flattest spot. You have the ability to make small, nudging adjustments. **It will not return to any designated return location.**

- An audible beep will play over the X10 Controller
- Mute this using the sound icon within the notification, or turn down all notifications using the Sound menu (Global Settings > Sound)

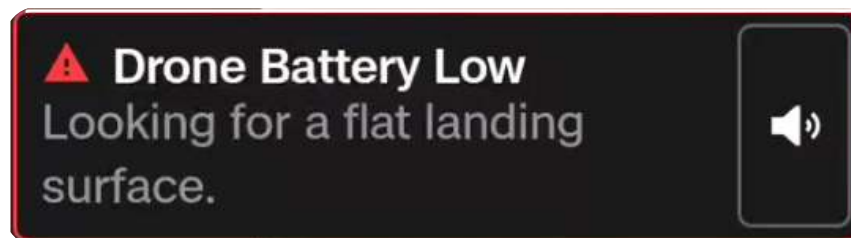

### Land Immediately

The battery level is critically low and the drone may power off mid-flight without warning. This warning appears if you chose to cancel the earlier **Drone Battery Low** automatic landing and continue flying.



**WARNING:** Continuing to fly greatly increases the risk of a crash, loss of the drone, or serious bodily harm or injury.

If the drone is descending toward an unsafe area (e.g., water, traffic), you may cancel the landing, move to a safer location, and then resume the landing process.

- A series of audible beeps will play over the X10 Controller
- Mute this using the sound icon within the notification, or turn down all notifications using the Sound menu (Global Settings > Sound)

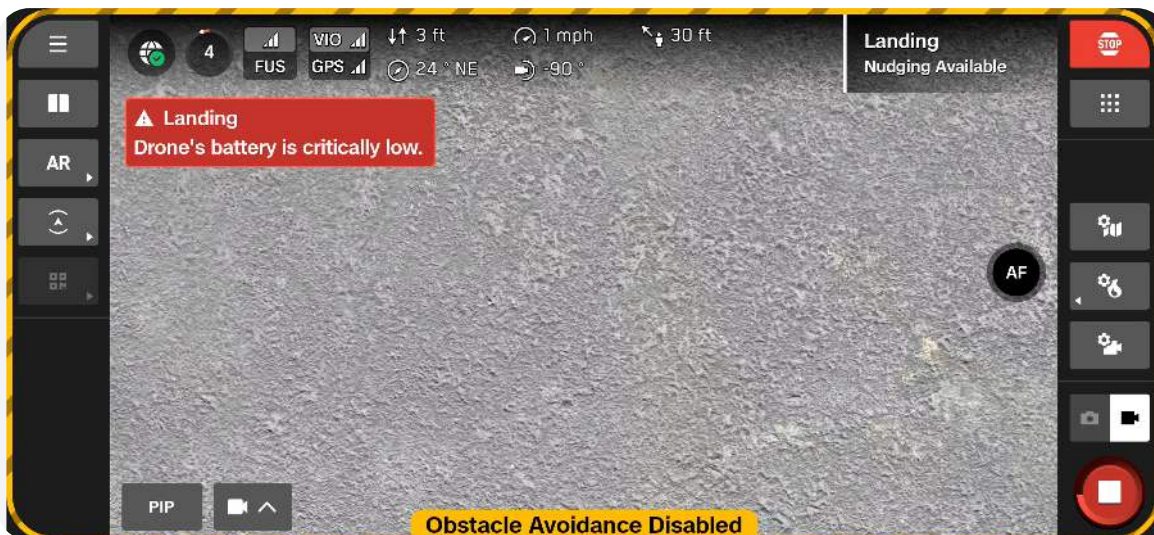
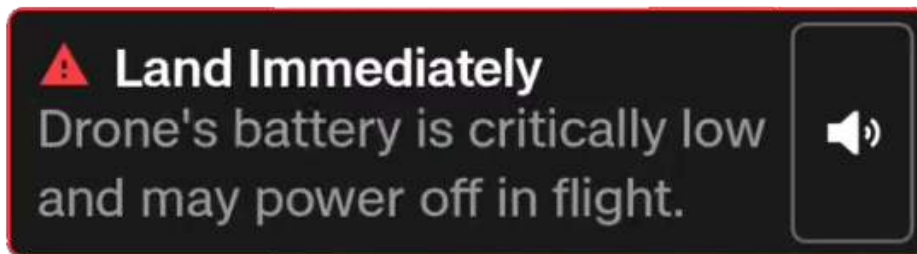

### Skydio X10 Controller

To help ensure a safe and uninterrupted flight, always launch with sufficient controller battery. If your battery drops below 20%, you will be notified on the Gate screen.

You will receive a series of notifications alerting you about the current status of the controller battery:

#### **Controller Battery Low**

When the X10 Controller battery reaches 10%, a **Controller Battery Low** notification will appear.

#### **Controller Battery Critical**

When the X10 Controller battery reaches 5%, a **Controller Battery Critical** notification will appear.

- If the controller powers off, the drone will follow the **Lost Connection** behaviors you have configured
- An audible beep will play over the X10 Controller
- Mute this using the sound icon within the notification, or turn down all notifications using the Sound menu (Global Settings > Sound)

## Reduced Performance State due to Battery Capability Limitation

At times of reduced battery performance, the drone will reduce its top speed and acceleration in order to enhance safety:

- Max ascent speed: 4.5 mph (2 m/s)
- Max ground speed: 27 mph (12 m/s)

Scenarios where the drone will have reduced battery performance include extreme cold, extremely low battery level, overheating, and cell imbalance.

 **Reduced Performance**  
The drone speed is reduced due to cold battery.

# Returning and Landing



**WARNING:** Obstacle avoidance is disabled when the drone is below 10 ft (3 m) during landing. Exercise extreme care to avoid injury or damage. Do not touch spinning propellers.



Scan for more information about Return and Lost Connection Behaviors.

Step 1 - Select the Return/Land button in the top right of your screen or on the controller

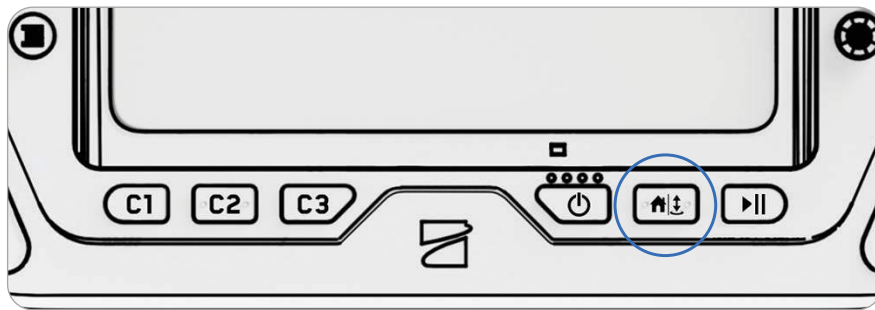
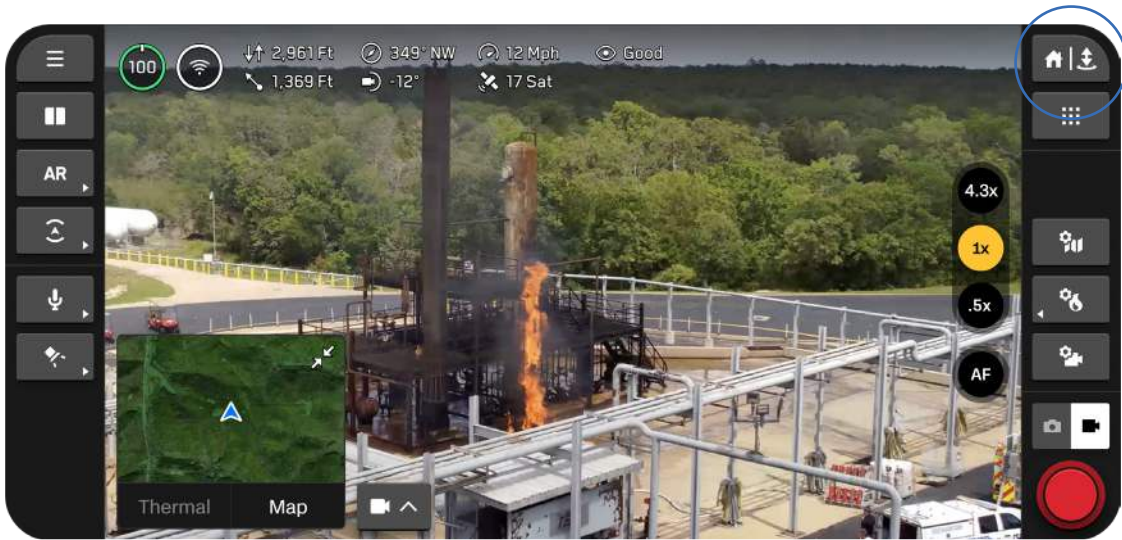

# Inflight Operations | Returning and Landing

## Step 2 - Choose your return location or land in place



### Home

Returns to a Home Point previously set on the map (GPS required)



### Launch

Returns to the Launch Point



### Pilot

Returns to the location of the Skydio X10 Controller

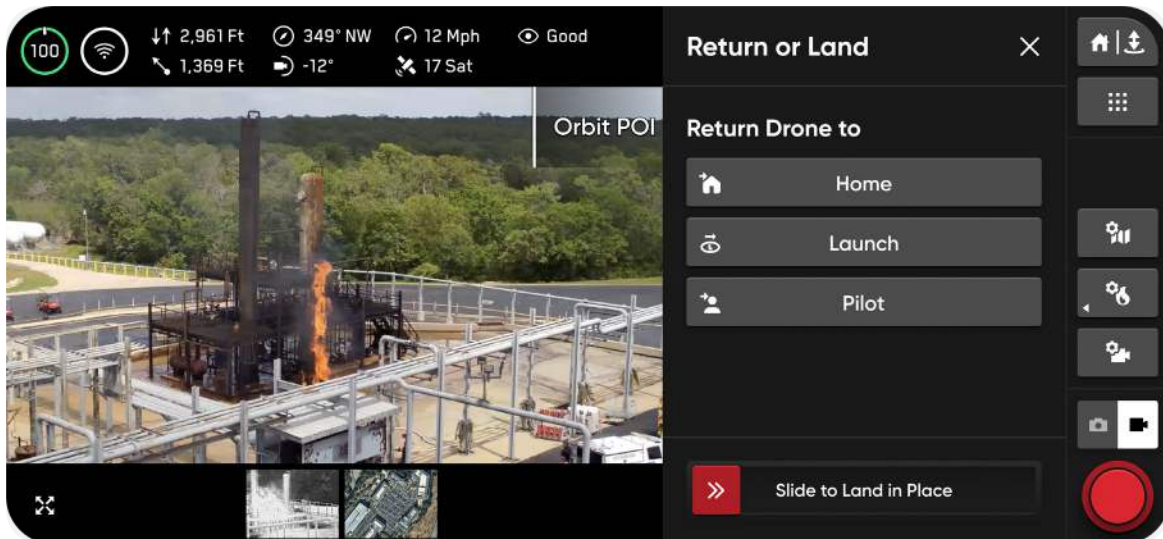

## Inflight Operations | Returning and Landing

---

You have three options when landing in place:

### Option 1 - Select and drag the on-screen slider

Landing begins when you lift your finger away from the screen.



### Option 2 - Press and hold the Return/Land button on the controller

Landing begins when you see the on-screen check mark.

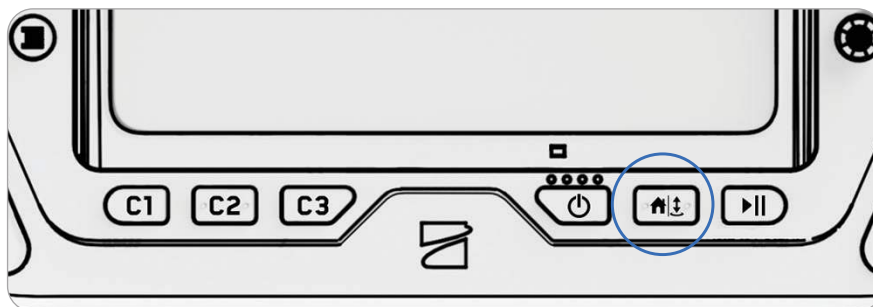

### Option 3 - Press and hold the Return/Land button on-screen

Landing begins when you see the on-screen check mark.



# Hand Landing



**WARNING:** Do not hand launch or hand land during windy days, when flying at night, or extreme environmental conditions as serious injury and/or damage may occur.



**WARNING:** Do not attempt to grab or catch Skydio X10 without initiating a landing, the motors will continue to spin at full speed and may cause severe injury. Do not attempt to hand land until the lights turn yellow. Attempting to hand land while obstacle avoidance is active will cause it to attempt to avoid your hand and may result in Skydio impacting yourself or another nearby object.

Landing Skydio X10 in your hand is a quick and convenient way to start or end your flight, particularly if you are not in a clear, level area. For your safety, always use caution when hand launching or landing.

### DO NOT ATTEMPT A HAND LANDING IF:

- There are high winds present.
- Skydio X10 is not stable in flight for any reason.
- Skydio X10 is performing an emergency landing after an accident or crash.
- You are in an area where you do not have stable footing.
- You are on a moving vehicle or boat.
- Skydio X10 is in Low Light mode, with or without NightSense.

## Inflight Operations | Returning and Landing

---

### **Step 1 - Position Skydio X10 above a clear area so that you can move underneath it**

Ensure the drone is facing away from you and extend your arm away from your body.

- The sensor package should face away from your body
- The back of the chassis and the battery are closest to you

### **Step 2 - Initiate landing**

Skydio X10 will descend vertically with full obstacle avoidance until it is 10 ft (3 m) above the ground.

Once your drone is below 10 ft (3 m), the lights on the drone turn yellow to indicate obstacle avoidance is disabled for the remainder of the landing.

### **Step 3 - Lightly grab the drone by the battery from underneath as it touches down on your open palm**

Once the battery has made contact with your palm, keep your hand steady until the propellers completely stop spinning.

# Contingency Behaviors



**WARNING:** While flying, always monitor Skydio Flight Deck for in-app alerts relating to battery levels, signal quality and other inflight notifications.



Scan for more information about Contingency Behaviors.



Before flying, ensure you have configured return settings, such as an automatic return on low battery, in the Return menu (**Global Settings > Return**).

Pilots must understand:

- Lost Connection
- Lost GPS
- Controller Overheating
- Emergency Landing and Attitude Mode
- Flight Termination

# Lost Connection



**WARNING:** Before flying, ensure you have set your Lost Connection Return Behaviors. This is a critical step that ensures your drone returns safely and lands in an accessible location.

If connection is lost, Skydio X10 will default to the **Lost Connection** settings. Select between **Return** (default) and **Hover**.

## Return (default)

**Wait Before Return** - set the amount of time you want Skydio X10 to wait before it initiates a return flight, allowing time to reconnect

**Land After Return** - when enabled, your drone will return, hover for a specified amount of time, then land.

**Wait Before Land** - the amount of time between 0 to 300 seconds (default is 240 seconds) that you want your drone to wait above the landing location before landing. This setting is only enabled when Land After Return is toggled on.

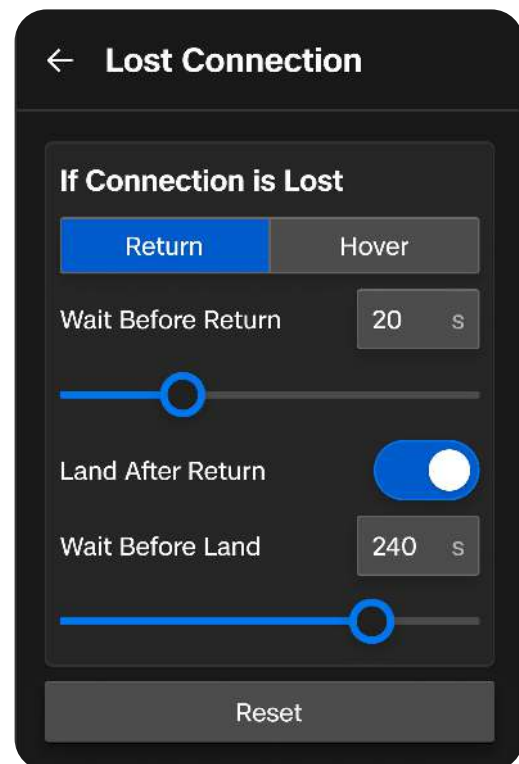

### Hover

**Land After Hover** - when enabled, Skydio X10 will hover for a specified amount of time, then use visual navigation to find a safe area to land.

**Wait Before Land** - the amount of time between 0 to 300 seconds (default is 240 seconds) that you want your drone to wait before landing. This setting is only enabled when Land After Hover is toggled on.

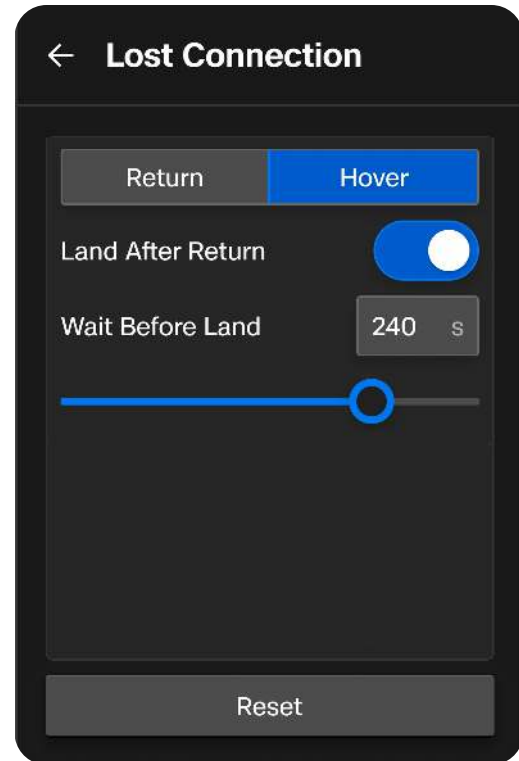

Skydio X10 will continue hovering as it tries to regain connection. If it fails to reconnect and reaches low battery:

- If you have an automatic return set, your drone will return to either the Launch Point or Home Point (if set)
- If you do not have an automatic return set, your drone will use visual navigation to find a safe area to land
- If you do not have strong VIO (e.g. you are flying in Low Light mode without NightSense), your drone will be unable to use visual navigation and will descend vertically and land

# Lost GPS

If Skydio X10 loses GPS signal, the drone will continue flying using the vision system. Actions that require GPS will be disabled.

If visual navigation (VIO) is also unavailable, the drone will enter Attitude Mode, a mode of flying that relies on the drone barometer to maintain altitude. By default, if there are no joystick inputs for 5 seconds, the drone will begin emergency landing.

# Controller Overheating

If the Skydio X10 Controller reaches critical temperatures and overheats in flight, it will shut down and lose connection to the drone, triggering the X10 Lost Connection behavior.



To mitigate overheating and reduce the risk of lost connection during flight, the controller will issue two alerts and provide guidance to the operator.

Alert	Operator Action
<b>Controller is Heating Up</b>	Take mitigation actions: <ul style="list-style-type: none"><li>• Move the controller screen out of direct sunlight</li><li>• Move to a shaded or cooler area if possible</li><li>• Continue flight - this alert is cancellable</li></ul>
<b>Controller Too Hot to Operate</b>	Take immediate action to land: <ul style="list-style-type: none"><li>• Launch will be prevented</li><li>• If the drone is in flight the signal between the controller and the X10 will be lost and your drone will default to the operator-defined lost connection settings</li><li>• This alert is non-cancellable</li></ul>

# Emergency Landing and Attitude Mode



**CAUTION:** Obstacle Avoidance is not available in Attitude Mode.



**NOTE:** Monitor your GPS and VIO health in the telemetry bar. If VIO and GPS both fail, your drone will enter Attitude Mode.

If both GPS and the visual navigation system (VIO) become unreliable, Skydio X10 will enter Attitude Mode.

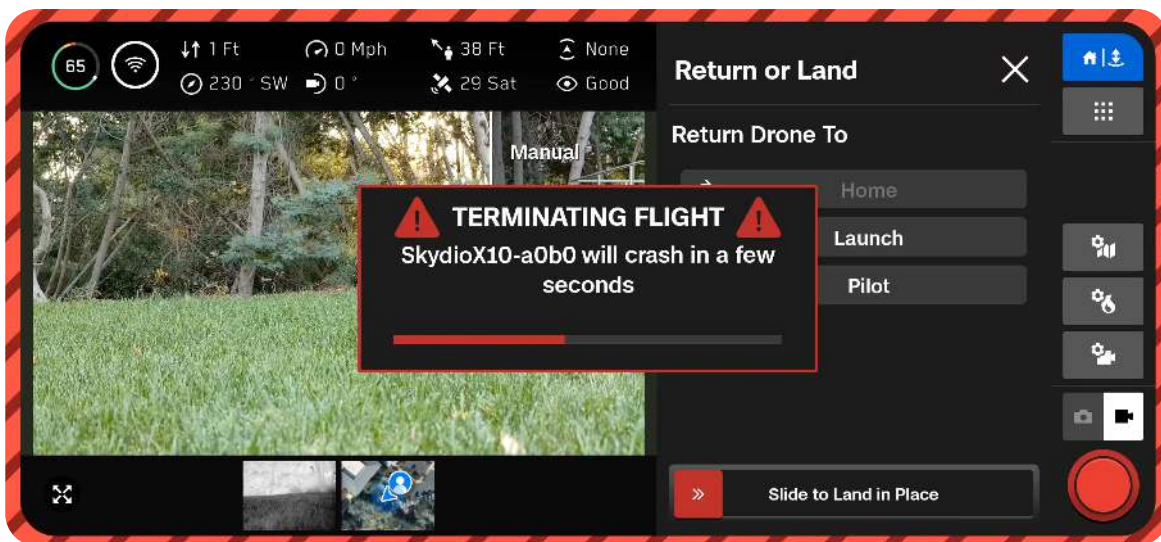

In this mode, the drone will use internal barometer readings to maintain altitude when the throttle joystick is centered.

The drone will drift, in which case you will need to adjust roll and pitch movements to maintain the drone's position. The drone will not automatically hold position or automatically brake when the joysticks are centered.

## Inflight Operations | Contingency Behaviors

If the drone regains GPS and/or VIO while in Attitude Mode, it will switch out of Attitude Mode and use whichever navigation system is strongest.

- To have the best chance of recovering VIO, descend below approximately 60 feet above the ground and fly within sight of visual features.
- When GPS becomes available again, a prompt will be displayed. Fly the drone horizontally (either left and right, or back and forth) to regain GPS heading and resume GPS navigation.

Navigate to **Global Settings > Flight Controls > Landing** to configure landing behavior while in attitude mode.

### Auto Land in Attitude

**Toggled ON (default)** - After 5 seconds of inactivity in Attitude Mode (i.e. the joysticks are centered and not touched), Skydio X10 will automatically initiate an emergency landing.

**Toggled OFF** - The drone will remain in attitude mode under joystick command until GPS/VIO navigation systems are healthy or you land.

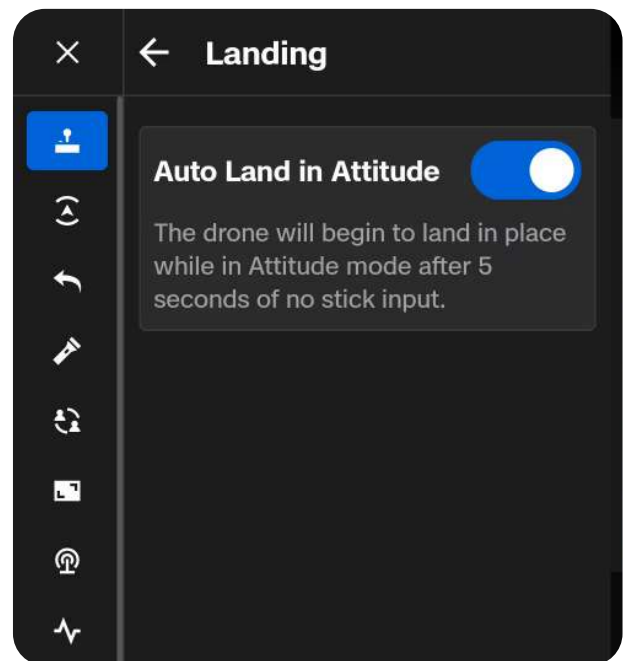

After 5 seconds of inactivity in Attitude Mode (i.e. the joysticks are centered and not touched in a neutral position and not engaged), Skydio X10 will automatically initiate an emergency landing and descend autonomously. An alert notification will display that Skydio X10 is initiating an emergency landing.

If you input any joystick command while the drone is emergency landing, it will stop descending and you can continue to fly in Attitude Mode.

### **Low Battery in Attitude Mode**

The drone will not return or land automatically at low battery while flying in Attitude Mode. It is your responsibility to monitor battery level and manually fly the drone to a safe landing location and land the drone when the battery is low. When the battery is low and the throttle stick is centered, the drone will descend to remind you that it is time to land.

### **Lost Connection in Attitude Mode**

If you lose connection with the drone while flying in attitude mode, the drone will descend and emergency land in place.

### **Landing in Attitude Mode**

To land the drone in attitude mode, you can press or hold the Land button to autonomously descend and touch down, or you can manually descend and touch down. The drone will automatically disarm and spin down the propellers after a few seconds when it detects that the drone is safely on the ground and the throttle joystick is held in a full down position.

# Flight Termination



**WARNING:** Terminating a flight will cause your drone to crash. Damage resulting from Flight Termination is not covered under warranty and may result in injury or damage. Use only in extreme situations.

In the event of an extreme emergency, you have the option to immediately terminate your flight. **Simultaneously press and hold the C3 button and Launch/Return/Land button for three seconds** while in flight to immediately stop the motors.

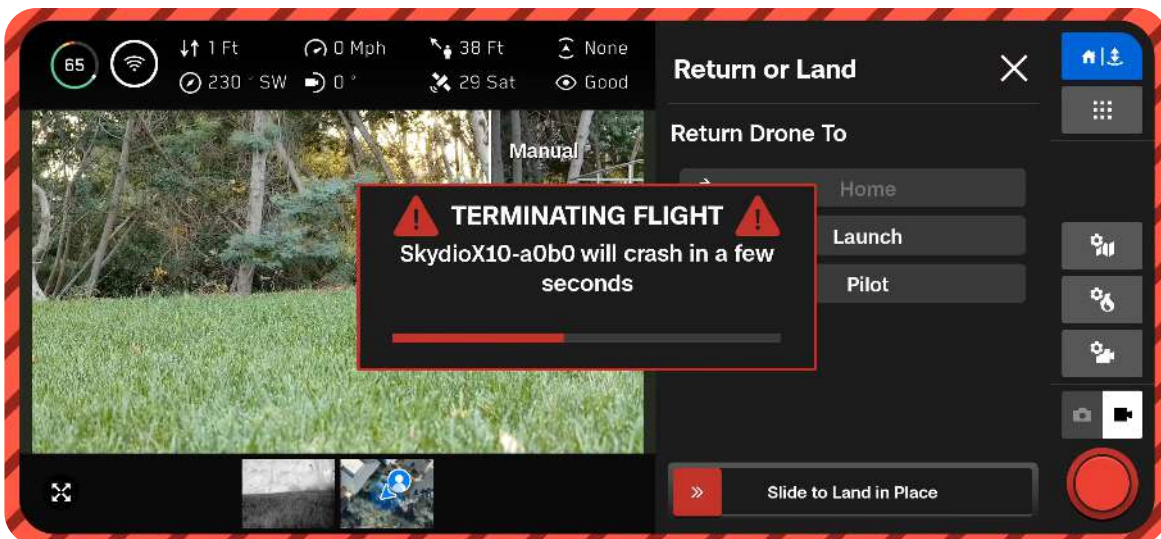



# Postflight

*Relevant Flight Crew Role(s): Pilot in Command (PIC), Organization Admins*

This phase focuses on verifying a successful landing, confirming that data and media are uploaded, and viewing or sharing key information.

## **This section covers**

---

Postflight Inspection

---

FAA Accident Reporting Requirements

---

Offloading Media

---

Logging out of the X10 Controller

---

Uploading Skydio Support Logs

---

Stowing Skydio X10

---

# Overview

When a flight is complete, the system automatically transitions into its postflight sequence. This phase focuses on verifying a successful landing, confirming that data and media are uploaded, and viewing or sharing key information.

Whether Pilots are preparing for another launch or wrapping up the day's operations, postflight tasks help ensure the system is healthy, that data is stored, and the organization remains mission-ready.

Pilots and Organization Admins must understand:

- Postflight Inspection
- FAA Accident Reporting Requirements
- Offloading Media
- Logging out of the X10 Controller
- Uploading Skydio Support Logs
- Stowing Skydio X10

# Postflight Inspection

## Landing

After landing, Pilots should notify all flight crew members on location. Conduct a physical inspection of the drone to ensure all components, such as propellers, lenses, and attachments, are free of damage.

More details on the types of landings can be found in *Inflight Operations > Returning and Landing*.

## Hot Sensor Package



**WARNING:** After prolonged use of the flashlight, your sensor package may be hot to the touch and could present a serious burn risk. After landing, wait for your sensor package to cool down before handling.

If you have the VT300-L or V100-L sensor package and use the flashlight for an extended period of time, the sensor package may be hot to the touch after flight and could present a serious burn risk. If the flashlight is used for the duration of a flight in ambient temperatures of 100°F (38°C), the sensor package can reach temperatures up to 142°C (61°C).

Monitor your controller for any safety notifications and be careful when handling the sensor package after flight.

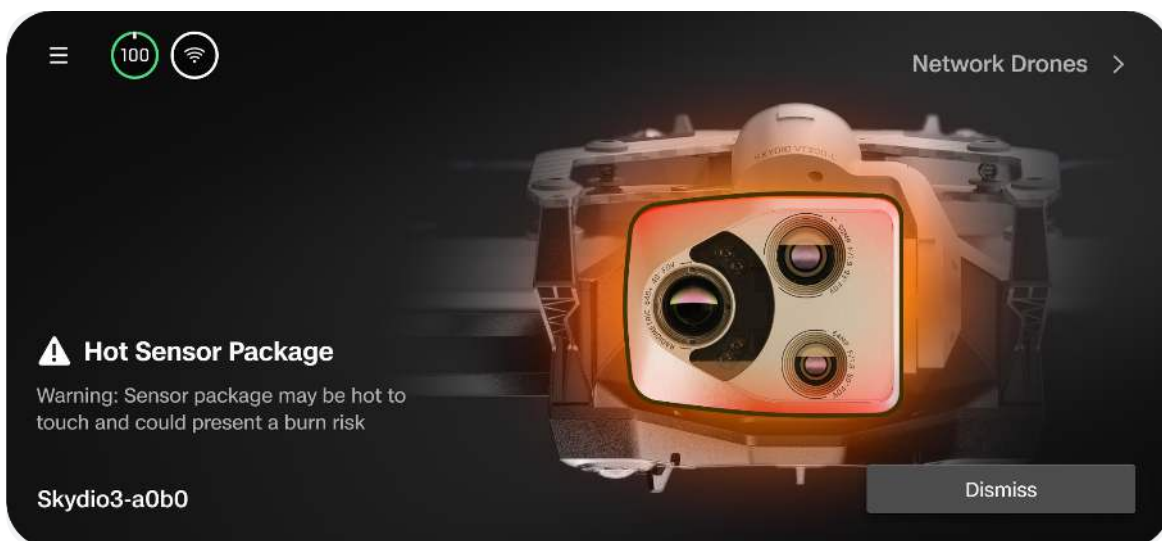

# FAA Accident Reporting Requirements

If an accident occurs during a drone flight, the RPIC is required to report it to the Federal Aviation Administration (FAA) within 10 days if any of the following are met:

- The accident results in serious injury to any person or any loss of consciousness
- The accident causes damage to any property (excluding the drone) exceeding \$500 to repair or replace

More detailed information can be found in the [FAA's guidance for Accident Reporting](#).

# Offloading Media

Select the **Media** menu within **Global Settings** to view photos, videos and scans from your recent flights.

- Select an image or video to view
- Press and hold on a thumbnail to select multiple or delete

If you captured photos using **Interval**, all photos captured will appear as a single stack. Selecting the stack will allow you to scroll through individual images one by one.

Only standard color and thermal JPGs will display in the Media menu. To access your DNG or RJPG files, you must transfer the files from your drone.



**NOTE:** *Media is not accessible inflight.*

### Transferring Media

**Step 1 - Power on Skydio X10**

**Step 2 - Connect X10 to your computer**

Insert the provided USB-C cable into the USB-C charging port on the back of your drone.

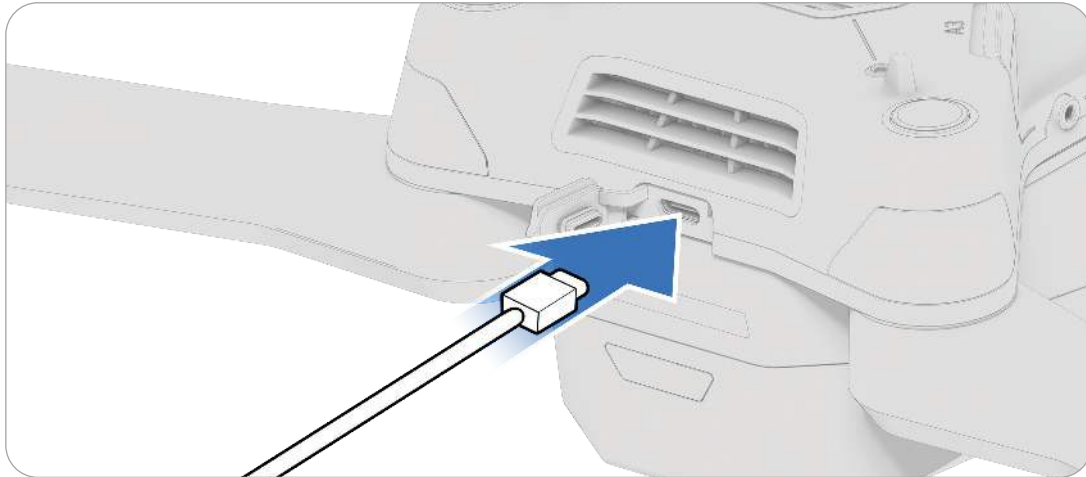

**Step 3 - Import your media**

If you are using an Apple product, use the Photos app or the Image Capture app to transfer your files.

# Logging Out of the Controller

Easily log out and switch between users of the same organization without factory resetting the controller. Your Skydio X10 and X10 Controller will stay paired between sign-ins.

Settings, media, and support logs are shared and persist between user accounts and logouts.

Navigate to **Global Settings** and select the profile icon in the top left to view the current account that is signed in, and select **Sign Out** to switch users.

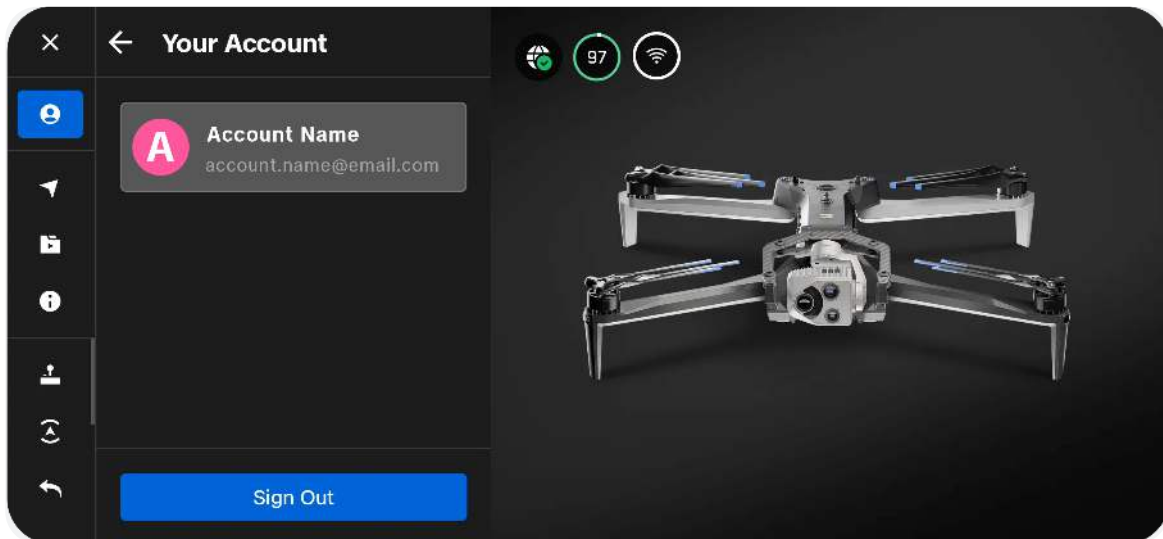

**NOTE:** Always review your settings when logging into a shared controller.

# Sending Skydio Support Logs



**WARNING:** *Powering off the drone immediately after a landing or a crash will result in missing data in the flight logs. Always allow your drone to complete postflight operations before powering off. Removing, swapping, or altering file names on the media card will impact the availability of the flight logs.*



**CAUTION:** *To maintain operational security and prevent conflicts with controller functionality, never sign in to personal or third-party accounts (such as Google Drive, Gmail, OneDrive, or other cloud services) on the X10 Controller. If you need to import maps or export logs, use the supported workflows provided by Skydio.*

Uploading your flight logs allows our support team to troubleshoot any issues or questions you may have.

**Do not reformat or factory reset your Skydio drone prior to contacting our support team.** Skydio will never review your videos or data without your permission.

# Postflight

When uploading to Skydio Support, monitor the upload progress of an individual flight directly from the Skydio Support Logs menu:

## Individual Flight Log Status

- **Not Started** – Log has not been uploaded
- **Partial** – Some data was uploaded, but the log is incomplete; when you retry, only the missing data will upload
- **Complete** – The log has been fully uploaded

## Individual File Status

- **Green** – Upload successful
- **White** – Upload failed; select the error icon (triangle) in the top right to view the files

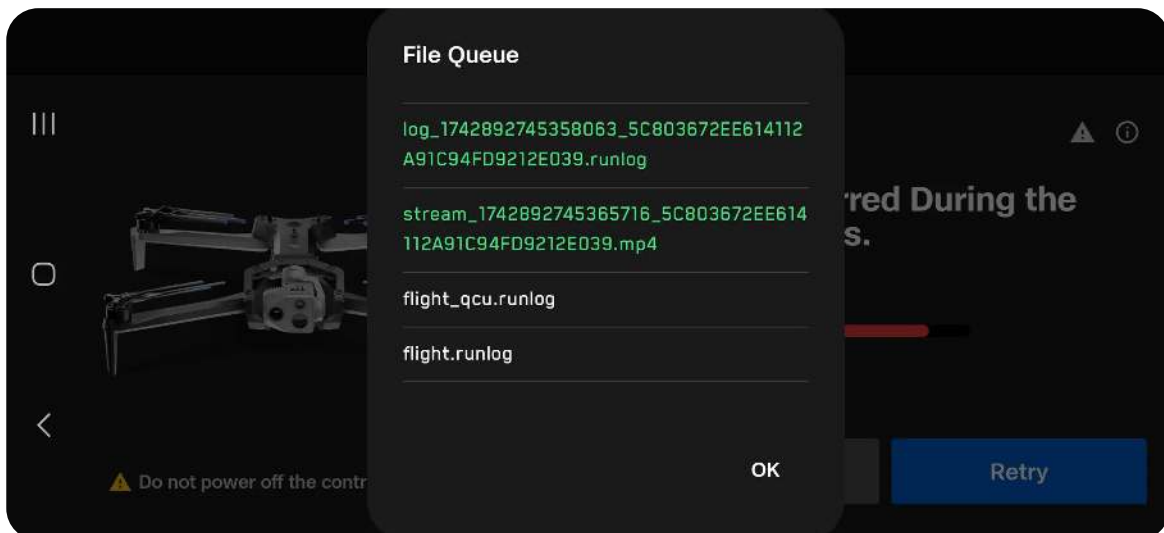
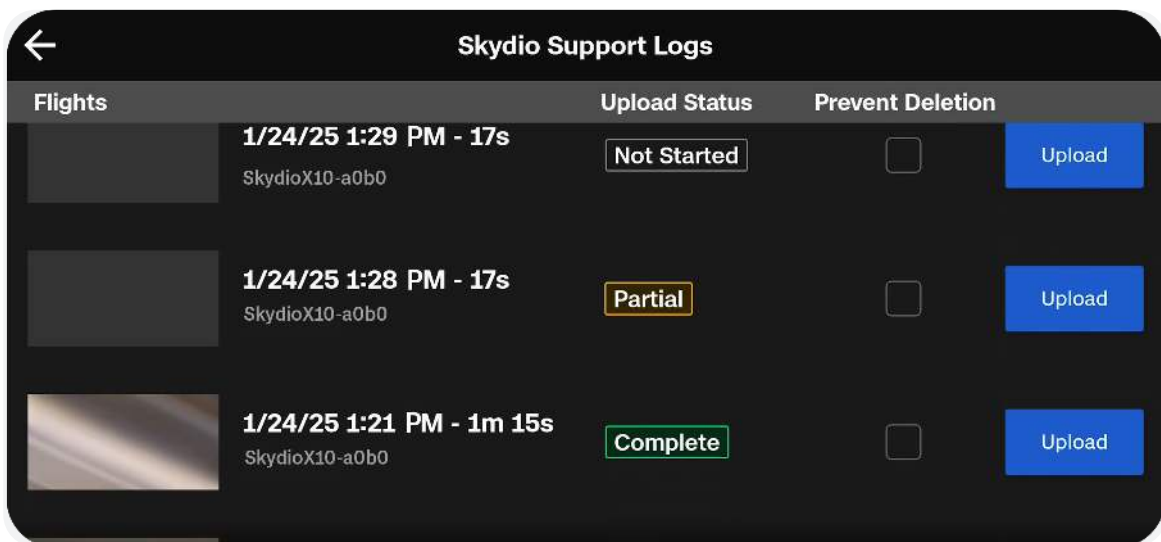

## Uploading Support Logs



**NOTE:** The transport of large support logs are not supported over 5G cellular.

### Step 1 - Power on Skydio X10 and the X10 Controller

Ensure your X10 Controller is fully charged.

### Step 2 - Navigate to Global Settings > Information

### Step 3 - Select Skydio Support Logs

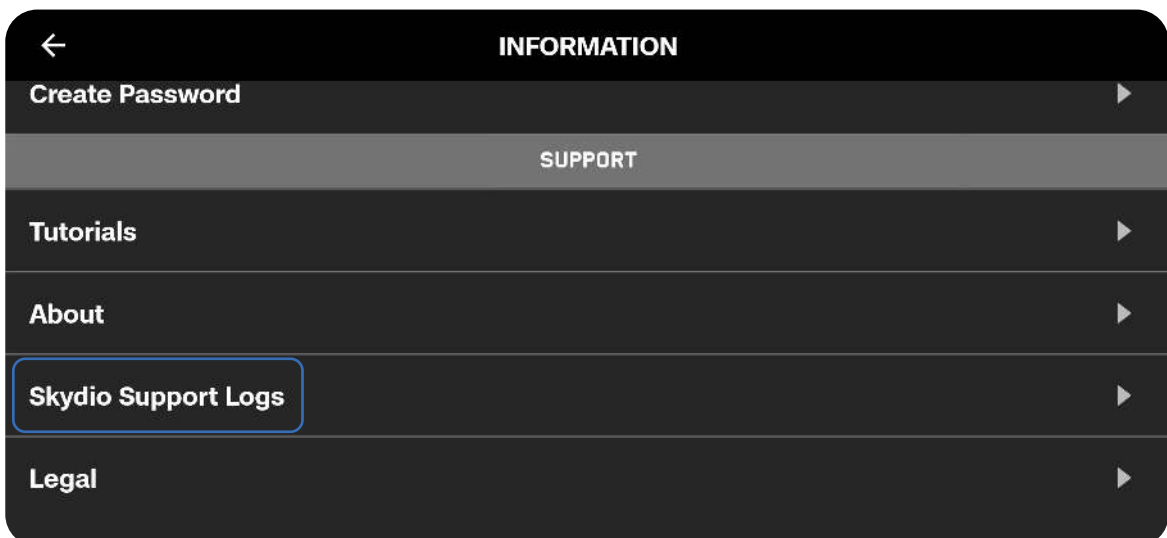
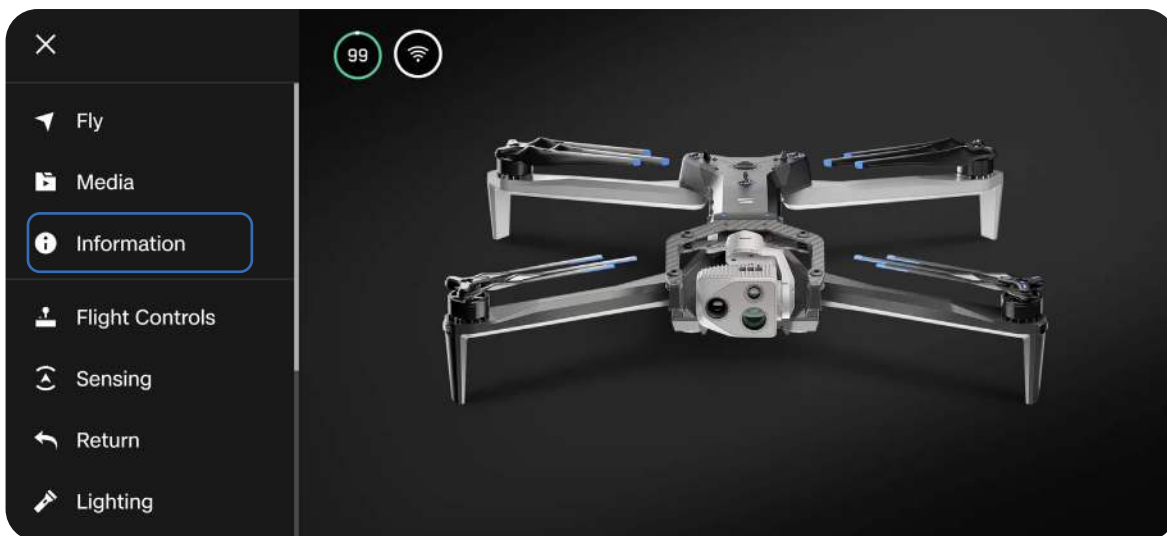

## Step 4 - Select Upload to Skydio Support

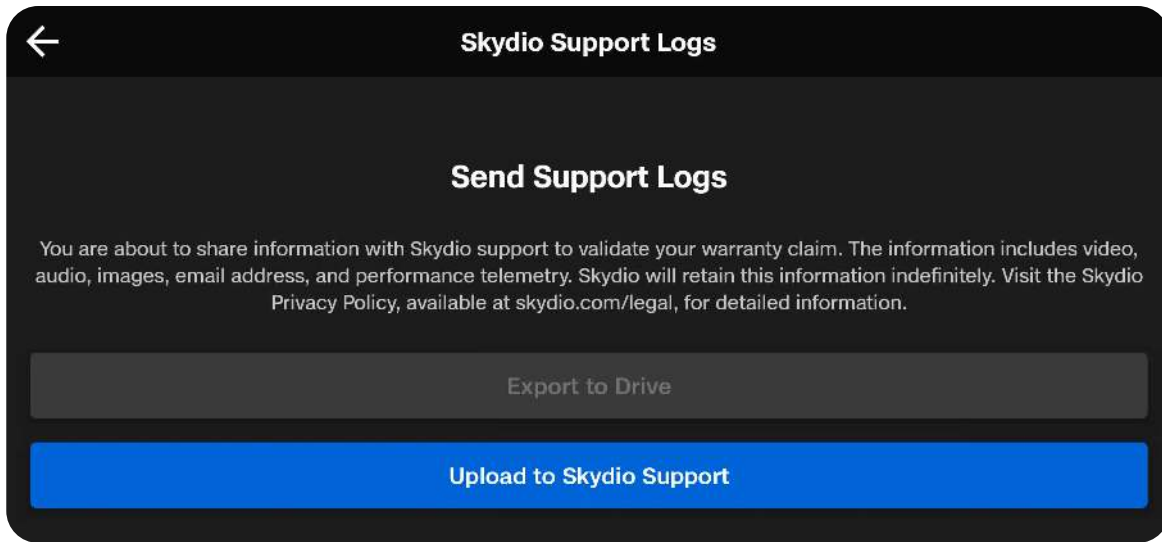

## Step 5 - Choose between a flight or controller logs

**Select Flight to Upload** includes all logs from a specified flight. This option will show you the history of all flights, organized by date and time. Select the individual flight you wish to upload.

**Send Controller Logs** uploads all flights saved on the controller from all flight history. This option allows you to sync logs whether or not you are connected to the drone.

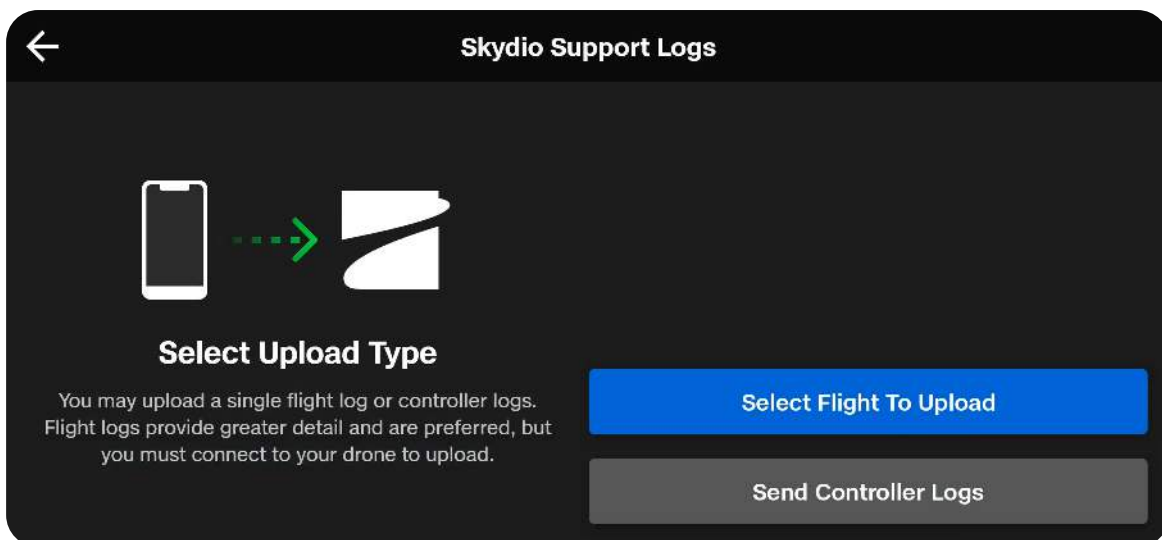

# Postflight

## Step 6 - Upload Flight Logs

If you selected **Select Flight to Upload** in the previous step, select which flight you wish to send to support.

Wait as your upload completes. You will see a summary after the upload finishes.

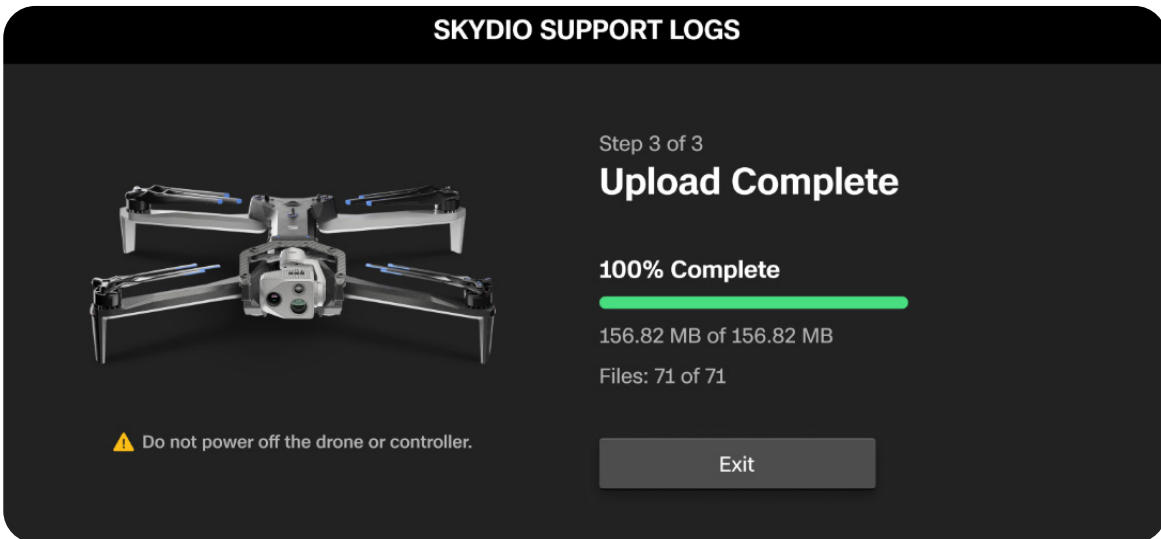
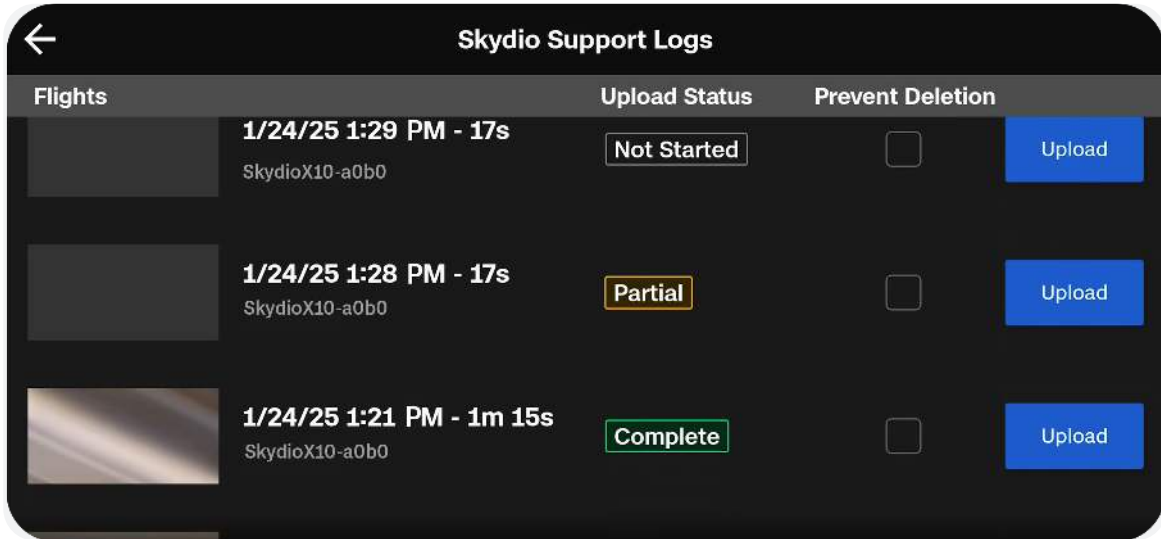

## Uploading Debug Logs

Depending on the issue, Skydio Support may ask you to upload debug logs.

### Step 1 - Power on Skydio X10 and the X10 Controller

Ensure your X10 Controller is fully charged.

### Step 2 - Navigate to Global Settings > Information

### Step 3 - Select the name of your X10 under Devices

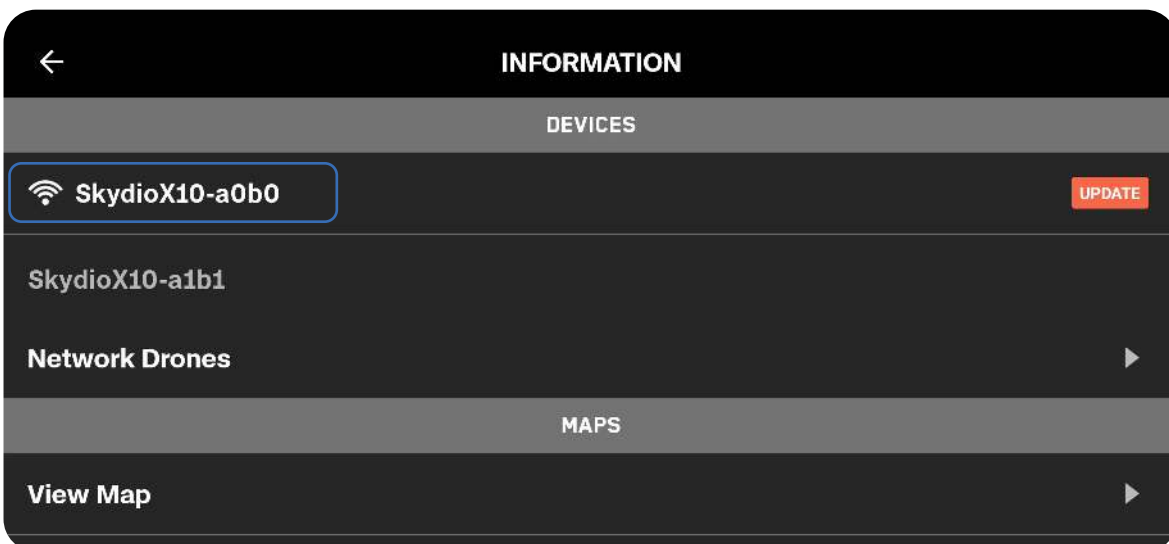

# Postflight

## Step 4 - Select Upload debug logs

It may take a few minutes for debug logs to upload to Skydio.

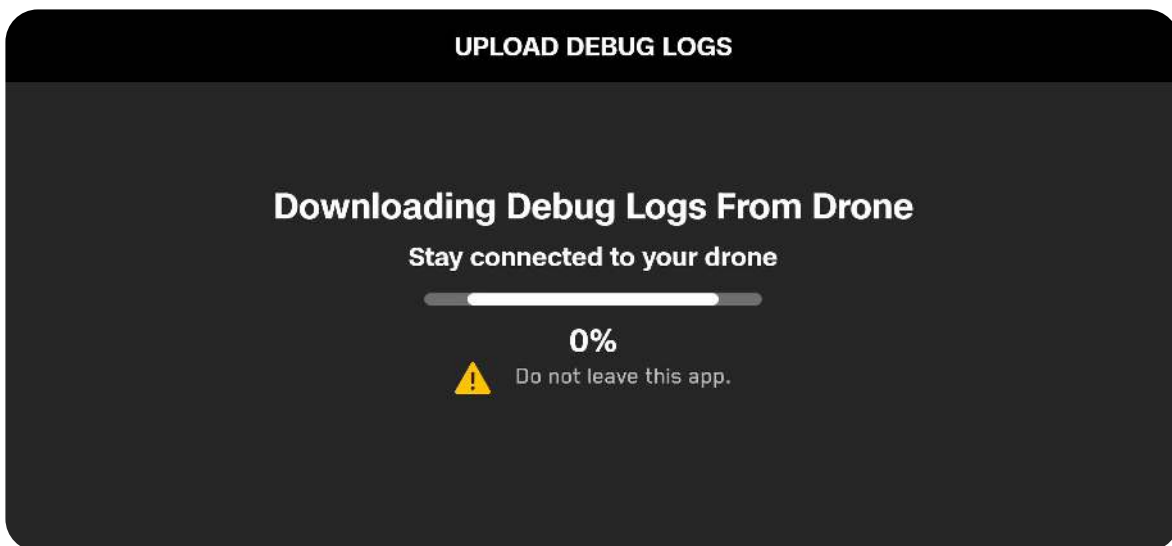
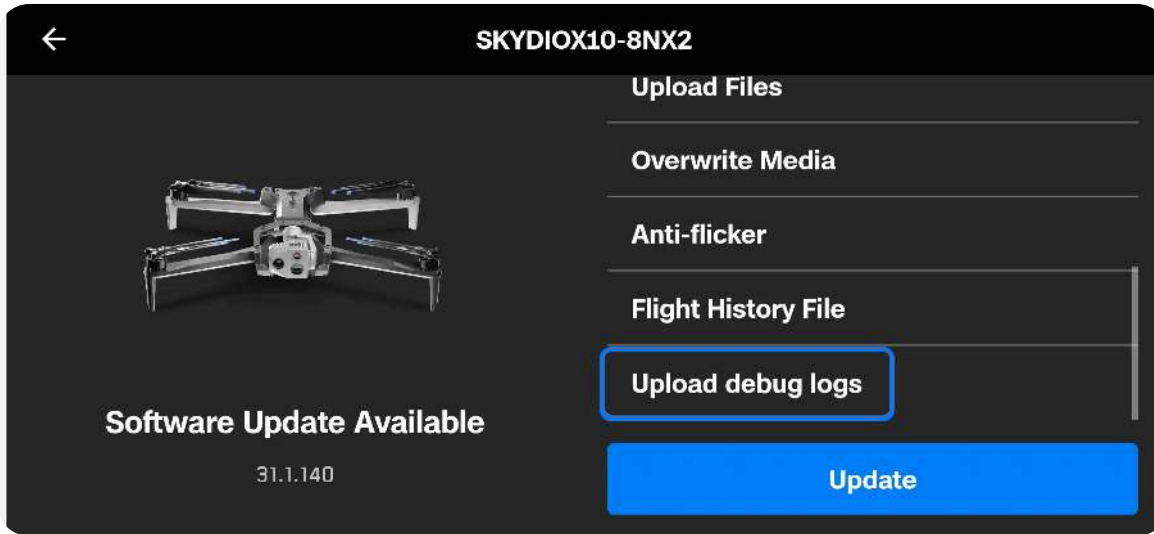

# Stowing Skydio X10

## Step 1 - Wait for postflight tasks to complete

If the battery is low while performing a longer postflight task, such as Onboard Modeling with Map Capture, ensure the drone is plugged into a power source.

- Powering off or removing the battery during postflight tasks will result in loss of data

## Step 2 - Power off Skydio X10 and the X10 controller

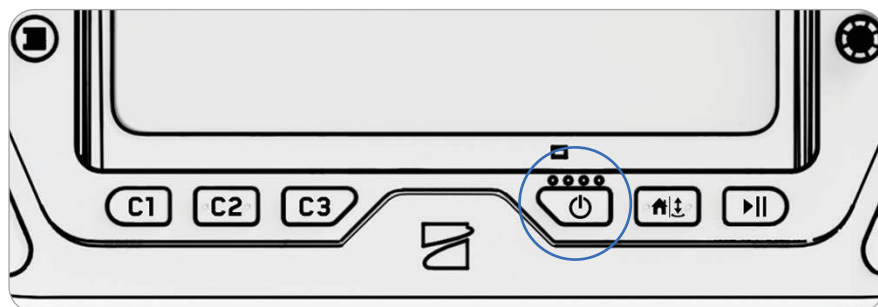
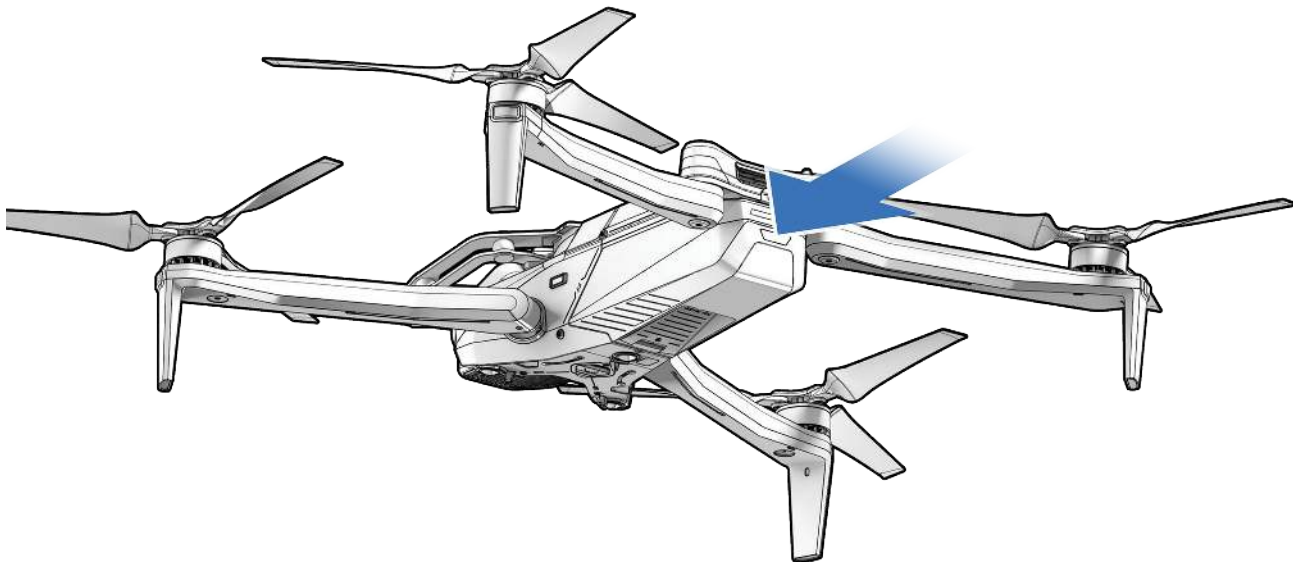

## Postflight

---

### Step 3 - Fold in the front arms

Hold the drone with the sensor package facing away from you. Gently pull the arm toward the back of the drone and rotate until it is tucked into place.

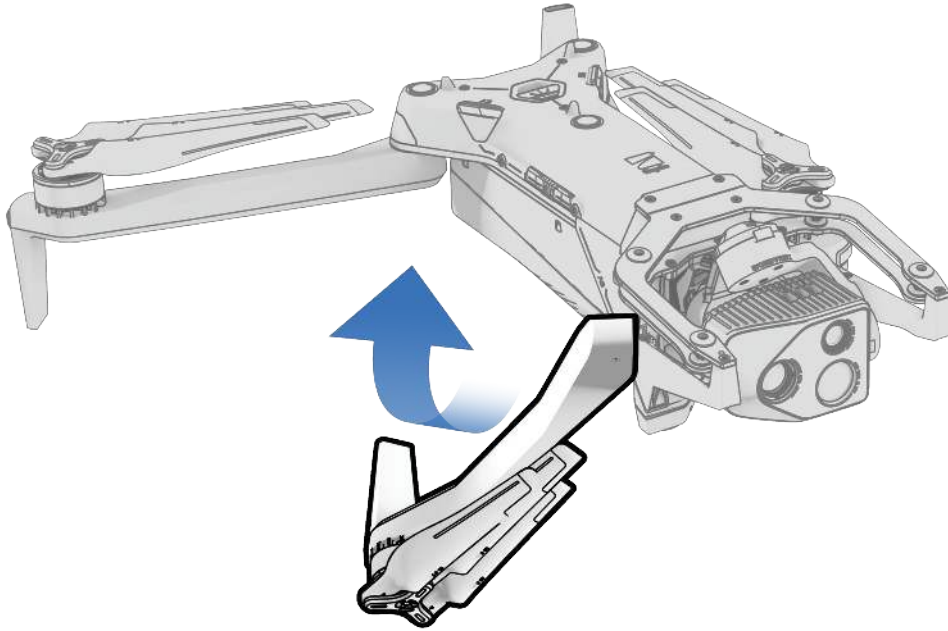

### Step 4 - Fold in the rear arms

Push laterally toward the chassis. Gently continue until you meet resistance.

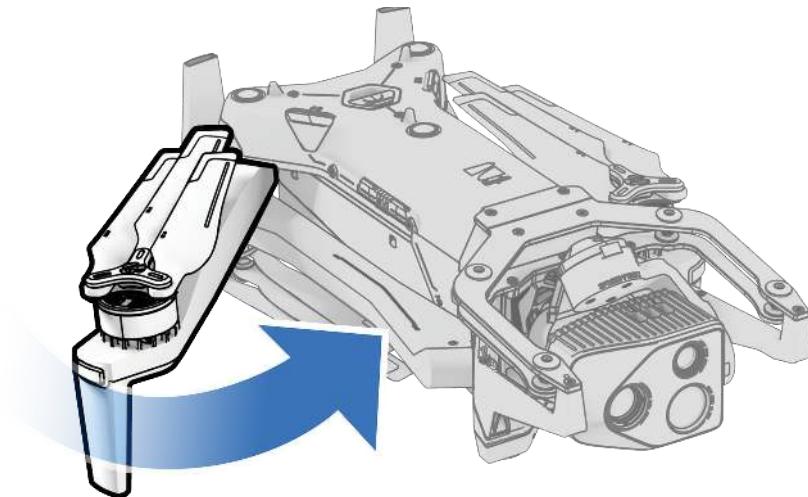

## Postflight

---

### Step 5 - Attach the gimbal stabilizer clip

Hold the sensor package and gently reattach the lock to the top of your drone.

- Ensure you are using the correct gimbal stabilizer clip for your sensor package. The clip label should match your gimbal version (for example, “VT300-Z REV2”). Using the wrong clip will prevent proper fit.

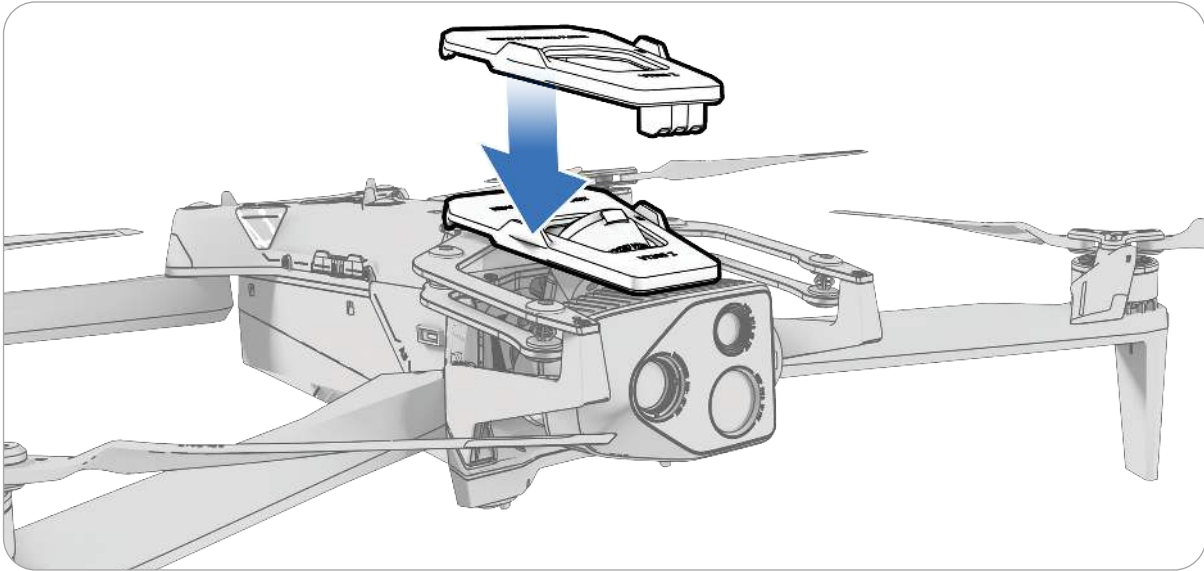

**NOTE:** Refer to the *Flying in Precipitation* section above for steps on how to properly store your drone after flight in precipitation.



# Maintenance

*Relevant Flight Crew Role(s): Organization Admins, Pilot in Command (PIC)*

Learn how to replace your propellers and best practices for battery and equipment storage.

## This section covers

---

Monitoring Your System in Skydio Cloud

---

Updating Your System

---

Replacing Propellers

---

Cleaning Your System

---

Storage

---

Maintenance Schedule

---

# Monitoring Drones and Batteries in Skydio Cloud

If you've claimed your Skydio X10 drones and batteries in Skydio Cloud, you can track the total number of flights and flight hours for each device.



**NOTE:** Skydio X10 drones and batteries must be claimed in Skydio Cloud to view this flight data. Visit the Skydio Cloud Setup section of this manual for instructions on how to claim your devices.

## Skydio X10

Navigate to Reports > Activity. Here you can view the total number of flights and total flight time for each drone in your fleet.

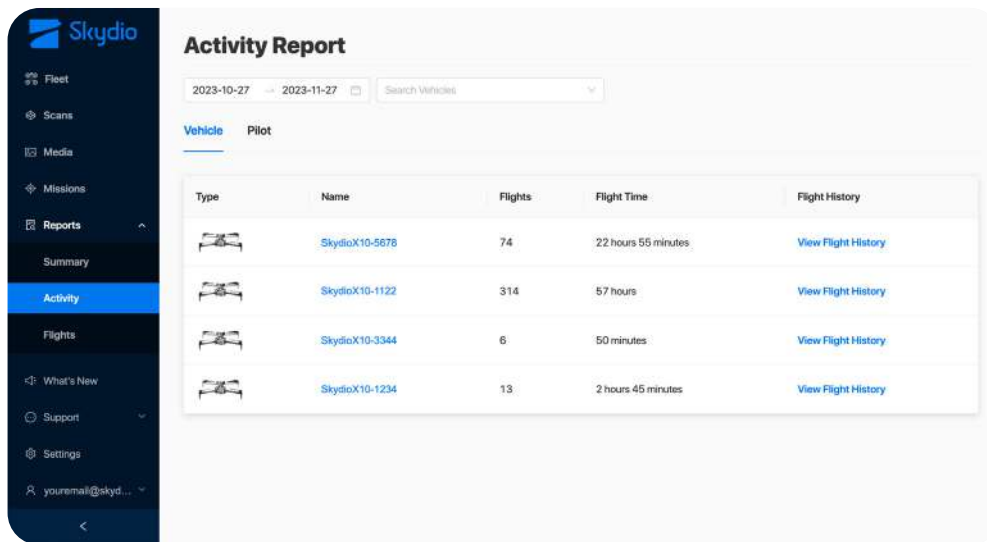

# Maintenance

Under the Flights tab you can also view a list of all flights, their duration, launch time, and more.

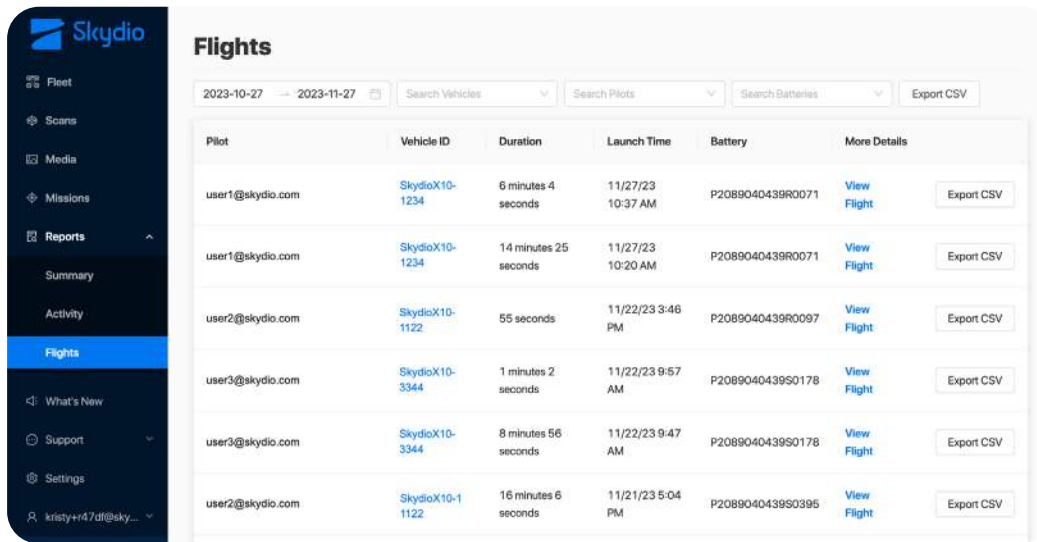

Pilot	Vehicle ID	Duration	Launch Time	Battery	More Details
user1@skydio.com	SkydioX10-1234	6 minutes 4 seconds	11/27/23 10:37 AM	P2089040439R0071	<a href="#">View Flight</a> <a href="#">Export CSV</a>
user1@skydio.com	SkydioX10-1234	14 minutes 25 seconds	11/27/23 10:20 AM	P2089040439R0071	<a href="#">View Flight</a> <a href="#">Export CSV</a>
user2@skydio.com	SkydioX10-1122	55 seconds	11/22/23 3:46 PM	P2089040439R0097	<a href="#">View Flight</a> <a href="#">Export CSV</a>
user3@skydio.com	SkydioX10-3344	1 minutes 2 seconds	11/22/23 9:57 AM	P2089040439S0178	<a href="#">View Flight</a> <a href="#">Export CSV</a>
user3@skydio.com	SkydioX10-3344	8 minutes 56 seconds	11/22/23 9:47 AM	P2089040439S0178	<a href="#">View Flight</a> <a href="#">Export CSV</a>
user2@skydio.com	SkydioX10-1122	16 minutes 6 seconds	11/21/23 5:04 PM	P2089040439S0395	<a href="#">View Flight</a> <a href="#">Export CSV</a>

## Skydio X10 Batteries

Navigate to Settings > Devices > Batteries. Here you can view the total number of flights, total flight time, and cycles for each battery in your fleet.

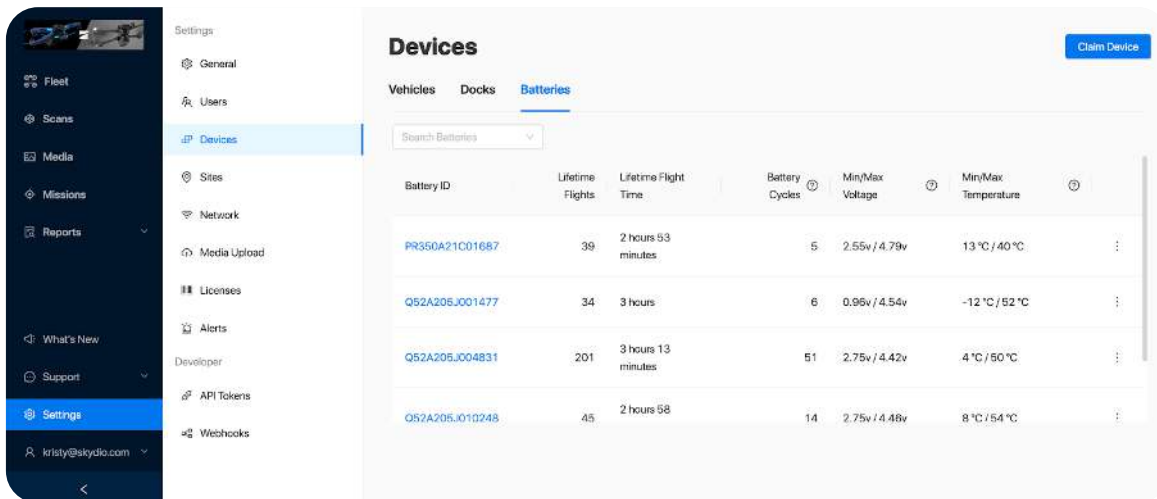

Battery ID	Lifetime Flights	Lifetime Flight Time	Battery Cycles	Min/Max Voltage	Min/Max Temperature
PR350A21C01687	39	2 hours 53 minutes	5	2.55v / 4.79v	13 °C / 40 °C
Q52A205J001477	34	3 hours	6	0.96v / 4.54v	-12 °C / 52 °C
Q52A205J004831	201	3 hours 13 minutes	51	2.75v / 4.42v	4 °C / 50 °C
Q52A205J010248	45	2 hours 58	14	2.75v / 4.48v	8 °C / 54 °C

# Updating Your System

Skydio will not force an update for your system, however, for optimal performance, we recommend that you keep your Skydio system up-to-date. If flying your Skydio X10 as part of a larger fleet or organization, follow your organization's update guidelines.

Visit **Updating Skydio X10** in the preflight section of this manual for detailed instructions.

# Replacing Propellers



**WARNING:** Propellers with hairline cracks or large breaks, chops, or bends should be replaced immediately. Do **NOT** fly Skydio X10 with propellers that are not in good condition as serious bodily harm or injury may occur.

For optimal performance, Skydio recommends replacing your propellers **after 250 hours of flight time** or whenever you notice any damage. Organization Admins have the ability to enable Propeller Hour Tracking in Skydio Cloud Settings.

## Step 1 - Remove old or damaged propeller set

Hold onto the motor with one hand and take the propeller hub in the other. Press down on the propeller hub and twist to release.

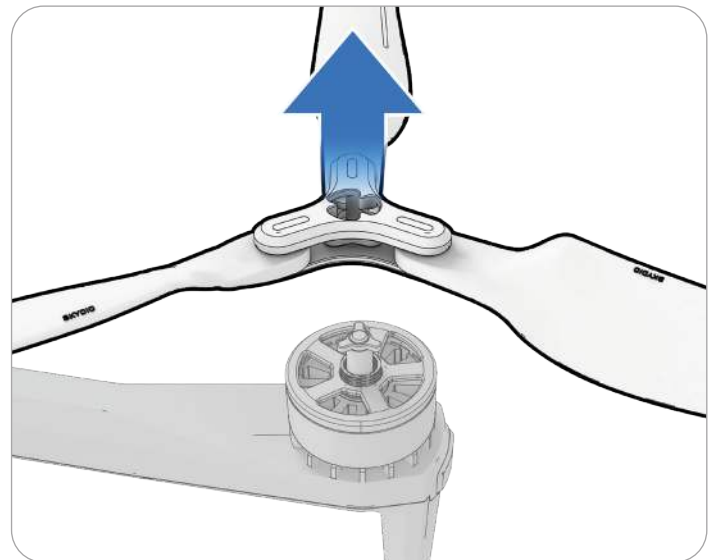
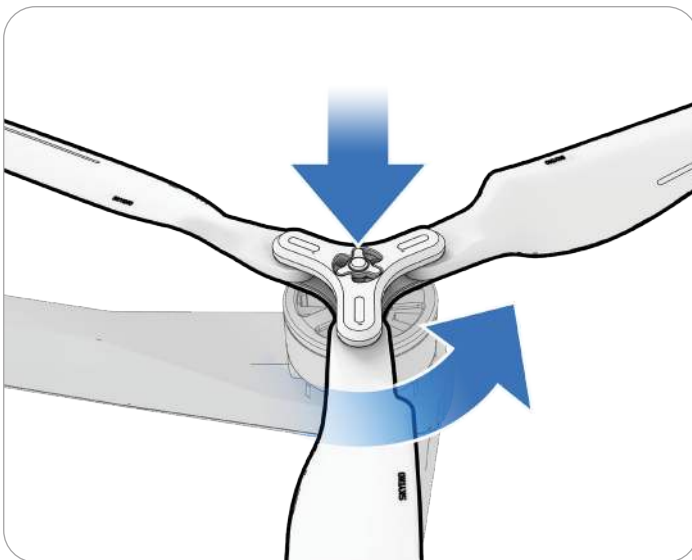

**NOTE:** You will need to twist either clockwise or counterclockwise depending on the motor.

## Maintenance

### Step 2 - Identify the propeller set that matches the motor

Match the replacement set of propellers to the color on the motor.

### Step 3 - Inspect for any debris

Inspect the motor to ensure there is no dirt or debris.

### Step 4 - Install new propeller set

Hold onto the motor with one hand and take the propeller hub in the other. Flip the propeller hub so the opening on the hub aligns with the motor. Press down and twist to lock in place.

Be gentle and do not force the fitment. If the propeller set does not fit on the motor it might be the incorrect set or side.

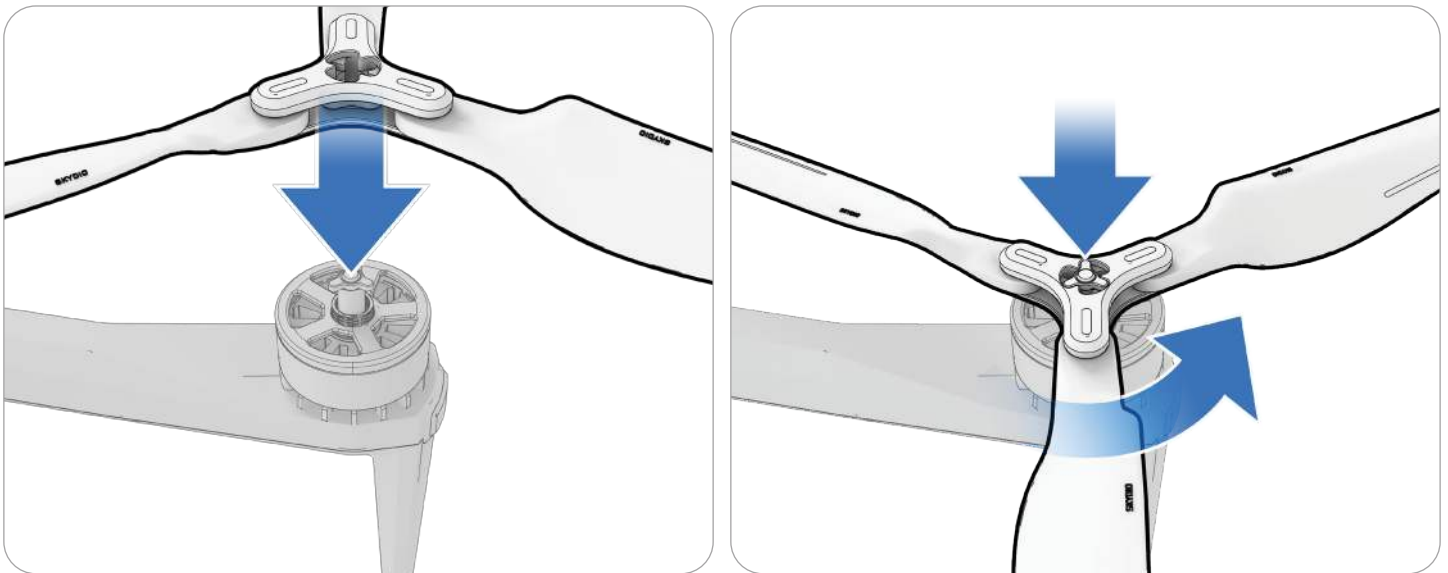

**NOTE:** You will need to twist either clockwise or counterclockwise depending on the motor.



**TIP:** The total number of flight hours for your drone is tracked in Skydio Cloud. Consider replacing all propellers at the same time for ease of tracking total propeller flight time.

# Cleaning Your System

It is recommended to wipe down your drone after flights in environments with significant dust or debris.



**WARNING:** Do not submerge your drone or batteries or place them under running water. Water volumes from flight in precipitation are much lower than those from a faucet or hose. Water may get into areas where the drone is not designed to withstand and you may compromise the sensors.

- Wipe down your drone with a dry or water-damp microfiber cleaning cloth.
- Only use lens cleaner on cameras.
- Do not submerge your drone or batteries.
- Do not place your drone or batteries under running water.
- Use a compressed air canister to remove any debris in hard to reach areas.
- If needed, mild soap and water may be used to remove heavier dirt or debris. Avoid getting any soap near ingress areas on the drone.
- Keep all the drain holes on the drone and battery clear. If any debris is blocking a drain hole (e.g., mud), use compressed air or gently scrape with a toothpick to remove.

# Storage

- Do not store Skydio X10 while wet. After flying in precipitation, allow the drone to air dry in a dry, temperature-controlled environment before stowing. Visit the **Flying in Precipitation** section of this manual for more information.
- Store batteries at room temperature 71°F - 82°F (22°C - 28°C) for optimal performance and longevity.
- Store batteries in a cool, dry area with less than 75% relative humidity. Do not store your batteries in extreme environmental conditions.
- Batteries in an idle state (14 days of idle time with no flights) will start to self-discharge in an effort to retain capacity. This may take several days to complete and it is normal for the battery to be slightly warm during this discharge process.

# Maintenance Schedule

To optimize the performance of your Skydio X10 it's important to keep your drone updated, inspect your equipment, store your equipment properly, and occasionally replace your propellers and batteries.

Action	Interval
<b>Update system</b>	When an update is available (per your organization's guidelines).
<b>Clean drone navigation cameras</b>	Before each operational session, and after sessions in dust or precipitation. If flying in areas with high amounts of dust or debris, you may be prompted to clean your camera lenses before each flight.
<b>Replace propellers</b>	Per 250 hours of flight time
<b>Replace battery</b>	Per 300 battery cycles A battery cycle is the depletion of at least 80% of the charge. An undamaged and properly stored battery can be safely used beyond 300 cycles.
<b>Inspect and/or replace sensor package isolators</b>	Every 40 flights or 30 hours of flight time. If you are storing the drone in hot temperatures (122°F/50°C to 131°F/55°C), then we recommend inspecting every 20 flights (or every 15 hours of flight time).



# Legal

This section covers

---

Safety

---

Battery

---

Skydio One (1) Year Limited Warranty

---

Skydio Care

---

California Prop 65 Warnings

---

FCC Compliance Statement

---

FAA Compliance Statement

---

# Skydio X10

Before operating Skydio X10, review the *Getting Started* information including the *Operator Manual* available at [www.skydio.com/manuals](http://www.skydio.com/manuals). Retain documentation for future reference.

### Safety

Review the *Skydio Safety and Operating Guide* available at [www.skydio.com/safety](http://www.skydio.com/safety).

### Battery

Handle the battery with extreme care and refer to the Operator Manual and to the *Skydio Safety and Operating Guide* for additional information.

Danger of explosion if battery is incorrectly replaced. Replace only with the same or equivalent type recommended by the equipment manufacturer. Carefully dispose of batteries according to manufacturer's instructions and to your local environmental laws and guidelines.

Risque d'explosion si la batterie n'est pas correctement remplacée. Remplacer uniquement par un type identique ou équivalent recommandé par le fabricant de l'équipement. Jeter les batteries conformément aux instructions du fabricant et aux lois et directives environnementales locales.

### Charging

Do not use the X10 Dual Charger near wet locations. To avoid the risk of electric shock, use only in dry locations. Do not allow anything to rest on the power cord. Do not locate this device where the cord will be abused by persons working on it. Do not overload wall outlets and extension cords as this can result into fire or electric shock.

N'utiliser pas le X10 Dual Charger à proximité d'endroits humides. Pour éviter tout risque de choc électrique, utiliser uniquement dans des endroits secs. Ne laisser rien reposer sur le cordon d'alimentation. Ne placer pas ce moniteur dans un endroit où le cordon pourrait être maltraité par les personnes travaillant dessus. Ne surcharger pas les prises murales et les rallonges car cela pourrait provoquer un incendie ou un choc électrique.

### **Skydio One (1) Year Limited Warranty**

Skydio warrants the included hardware product against defects in materials and workmanship in hardware under normal use in accordance with published guidelines including but not limited to the *Terms of Use*, *Operator Manual* and the *Skydio Safety and Operating Guide* for one year from the date of delivery (the “Limited Warranty”). The Limited Warranty does not warrant against normal wear and tear or damage caused by accident or abuse and is not applicable to any software provided with the hardware product. The Limited Warranty is subject to the full terms and detailed information about how to obtain service available at [www.skydio.com/legal/limited-warranty](http://www.skydio.com/legal/limited-warranty). If you submit a valid claim under this Limited Warranty, Skydio will either repair, replace, or refund your hardware product at its sole discretion. You may be required to furnish proof of purchase details when making a claim under this Limited Warranty.

### **Skydio Care**

Skydio offers Skydio Care as a subscription service at an additional cost that provides protection from collisions, water damage, or lost drones which are not covered under the Limited Warranty. Skydio Care can be purchased as a one (1) year plan co-extensive with the Limited Warranty, or as a three (3) year plan, which includes a two (2) year extension to the one (1) year term of the Limited Warranty. Skydio Care is subject to the full terms and detailed information about how to obtain service available at <https://www.skydio.com/legal/skydio-care-terms-of-service>. If you submit a valid claim under Skydio Care, you may be eligible to purchase discounted drone replacements for otherwise uncovered damage or losses. The Skydio Care benefits are in addition to the rights provided under the Limited Warranty.

### **California Prop 65 Warnings**

Skydio X10 uses lithium-ion batteries. Exposure to lithium-ion, containing cobalt lithium nickel oxide, and nickel, is known to the State of California to cause cancer and birth defects, or other reproductive harm. For more information visit:

[www.P65Warnings.ca.gov](http://www.P65Warnings.ca.gov)

Skydio X10 Controller contains chemicals including cadmium, which is known to the State of California to cause cancer and birth defects, or other reproductive harm. For more information visit: [www.P65Warnings.ca.gov](http://www.P65Warnings.ca.gov)

Skydio X10 Dual Charger contains chemicals including BPA and nickel, which are known to the State of California to cause cancer and birth defects, or other reproductive harm. For more information visit: [www.P65Warnings.ca.gov](http://www.P65Warnings.ca.gov)

### **FCC and ISED Compliance Statement**

These devices comply with Part 15 of the FCC Rules and with ISED Canada license-exempt RSS standard(s). Operation is subject to the following two conditions: (1) these devices may not cause harmful interference, and (2) these devices must accept any interference received, including interference that may cause undesired operation. The X10 drone should be operated with a minimum distance of 8.5 in (22 cm) between the X10 drone antennas and your body.

Le drone X10 devrait être utilisé à une distance minimale de 8.5 po (22 cm) entre les antennes de drone X10 et votre corps. Ces appareils sont conformes aux normes RSS exemptes de licence d'ISDE Canada. Leur fonctionnement est soumis aux deux conditions suivantes: (1) ces appareils ne doivent pas causer d'interférences nuisibles, et (2) ces appareils doivent accepter toutes interférences reçues, y compris les interférences susceptibles d'entraîner un fonctionnement indésirable.

Changes or modifications not expressly approved by Skydio could void the user's authority to operate these devices.

These devices have been tested and found to comply with the limits for a Class A digital device, pursuant to part 15 of the FCC Rules. These limits are designed to provide reasonable protection against harmful interference when these devices are operated in a commercial environment. These devices generate, use, and can radiate radio frequency energy and, if not installed and used in accordance with the Operator Manual and Safety and Operating Guide, may cause harmful interference to radio communications. Operation of these devices in a residential area is likely to cause harmful interference in which case the user will be required to correct the interference at his own expense.

This Class A digital apparatus complies with Canadian ICES-003.

Cet appareil numérique de classe A est conforme à la norme Canadienne NMB-003.

# Legal

---

## FAA Compliance Statement

Unless specifically exempt, this product complies with 14 CFR Part 89 regulations on Remote Identification per ASTM F3411-22a-RID-B and ASTM F3586-22.

## Software License

The *Skydio Software End-User License Agreement* available at [www.skydio.com/legal/eula](http://www.skydio.com/legal/eula) governs the use of any Skydio software that is pre-installed, downloaded, installed, or otherwise provided in connection with any included hardware.

## Additional Resources

For all the latest information about Skydio and our products visit: [www.skydio.com](http://www.skydio.com)

For Skydio legal information and product terms of use visit: [www.skydio.com/legal](http://www.skydio.com/legal)

Skydio products are protected by patents and trademarks, registered in the United States and other countries. For Skydio intellectual property information visit: [www.skydio.com/legal/ip](http://www.skydio.com/legal/ip)

© 2026 Skydio, Inc. All rights reserved. Skydio and the Skydio logo are trademarks of Skydio, Inc., registered in the United States and other countries.

